

AS 3740:2021



STANDARDS  
Australia



# Waterproofing of domestic wet areas



Share your feedback  
about this Standard.  
Scan the QR code on your  
phone or click/ enter the  
link to take the survey  
[feedback.standards.org.au/3740:2021](https://feedback.standards.org.au/3740:2021)

AS 3740:2021

This Australian Standard ® was prepared by BD-038, Wet Areas In Buildings. It was approved on behalf of the Council of Standards Australia on 7 July 2021.

This Standard was published on 23 July 2021.

The following are represented on Committee BD-038:

- Association of Wall and Ceiling Industries of Australia
- Australasian Concrete Repair and Remedial Building Association
- Australian Building Codes Board
- Australian Industry Group
- Australian Institute of Building Surveyors
- Australian Institute of Waterproofing
- Australian Tile Council
- Better Regulation Division
- CSIRO
- Engineered Wood Products Association of Australasia
- Housing Industry Association
- Institute of Building Consultants

This Standard was issued in draft form for comment as DR AS 3740:2020.

### **Keeping Standards up-to-date**

Ensure you have the latest versions of our publications and keep up-to-date about Amendments, Rulings, Withdrawals, and new projects by visiting:

[www.standards.org.au](http://www.standards.org.au)

ISBN 978 1 76113 435 7

# Waterproofing of domestic wet areas

Originated as AS 3740—1989.  
Previous edition AS 3740—2012.  
Fifth edition AS 3740:2021.

Standards Australia Ltd 2021

All rights are reserved. No part of this work may be reproduced or copied in any form or by any means, electronic or mechanical, including photocopying, without the written permission of the publisher, unless otherwise permitted under the Copyright Act 1968 (Cth).

## Preface

This Standard was prepared by the Standards Australia Committee BD-038, Wet Areas in Buildings, to supersede AS 3740:2010.

The objective of this document is to set out the criteria for waterproofing wet areas within domestic buildings. It gives minimum requirements for materials, designs and installations.

The objective of this revision is to bring this document in line with the current waterproofing practices in the building industry.

Changes from the previous edition include the following:

- (a) Restructure for useability.
- (b) Addition of figures with examples of application.
- (c) Addition of information on risk levels of different areas.
- (d) Inclusion of appropriate details for various risk levels.
- (e) Clarification of usage definitions.
- (f) Increased ease of reference for varying conditions.
- (g) Revision of design and installation techniques.
- (h) Expansion of information on shower and bath scenarios.
- (i) Inclusion of informative integrity testing.

The role of waterproofing is to install waterproofing systems as a combination of waterproof and water-resistant materials in order to retain water within the designated wet area and exclude water from non-water-resistant building elements. It is intended that water be managed to an outfall at surface and substrate. Systems are intended to accommodate expected service conditions of the wet area to prevent damage by water and accumulated moisture to building elements.

This document is not to be interpreted as preventing the use of materials, systems or methods that meet the design and installation criteria set out in this document, but are not specifically referred to herein (alternative solution).

Additional requirements may need to be considered for wet areas intended for use by people with disabilities.

Standards Australia thanks Stormtech for permission to reproduce the following: [Figure 4.3.1\(A\)](#), [Figure 4.3.1\(B\)](#), [Figure 4.3.1\(C\)](#), [Figure 4.3.2](#), [Figure A.6\(C\)](#) and [Figure A.6\(D\)](#). These figures are copyright of Stormtech. All rights reserved.

The terms “normative” and “informative” are used in Standards to define the application of the appendix to which they apply. A “normative” appendix is an integral part of a Standard, whereas an “informative” appendix is only for information and guidance.

# Contents

<b>Preface</b> .....	<b>ii</b>
<b>Section 1 Scope and general</b> .....	<b>1</b>
1.1 Scope.....	1
1.2 Normative references.....	1
1.3 Terms and definitions.....	2
<b>Section 2 Design</b> .....	<b>7</b>
2.1 Design principles.....	7
2.1.1 General.....	7
2.1.2 Material selection.....	7
2.2 Shower classification.....	7
2.2.1 Enclosed showers.....	7
2.2.2 Unenclosed showers.....	7
2.3 Requirements for fall.....	8
2.3.1 Falls in substrate.....	8
2.3.2 Falls in shower area floor finishes (Category 1).....	8
2.3.3 Falls in wet area floor finishes adjacent to shower area where there is a floor waste (Category 2).....	8
2.3.4 Falls in wet area floor finishes where there is no floor waste (Category 3).....	8
2.3.5 Whole of bathroom designed as an unenclosed shower.....	9
<b>Section 3 Materials</b> .....	<b>10</b>
3.1 Scope of section.....	10
3.2 Compatibility.....	10
3.3 Materials.....	10
3.3.1 Waterproof.....	10
3.3.2 Water-resistant substrates.....	10
3.3.3 Water-resistant surface materials.....	11
3.4 Preformed, prefinished shower bases and enclosures.....	11
3.5 Sealants.....	11
3.6 Fastenings for substrate sheet linings.....	12
3.7 Adhesives.....	12
<b>Section 4 Installation</b> .....	<b>13</b>
4.1 Scope of section.....	13
4.2 Membrane installation for tile bed or screed.....	13
4.3 Membrane to drainage connection.....	13
4.3.1 Leak control flanges.....	13
4.3.2 Linear drainage connections.....	15
4.4 Surface preparation.....	16
4.4.1 Surface preparation.....	16
4.4.2 Requirements for fall in substrate.....	16
4.4.3 Moisture content of substrates.....	17
4.4.4 Wall sheeting preparation.....	17
4.4.5 Render preparation.....	17
4.5 Membrane application.....	17
4.5.1 Installation of an external membrane.....	17
4.5.2 Curing of membranes.....	17
4.5.3 Membrane inspection.....	18
4.5.4 Additional continuity testing.....	18
4.6 Membrane termination.....	19
4.6.1 Termination of membranes at shower recess waterstops.....	19
4.6.2 Termination of membranes at showers with hobs.....	19
4.6.3 Vertical membrane termination.....	20
4.7 Hob construction.....	20
4.8 Waterstops.....	20

4.8.1	General	20
4.8.2	Waterstop for unenclosed showers	20
4.8.3	Waterstops for enclosed showers	23
4.8.4	Waterstop for enclosed showers without hobs or set-downs	23
4.8.5	Showers located near exits to wet areas	24
4.9	Door openings	25
4.9.1	Perimeter flashing at floor level openings	25
4.9.2	Protection of door frames and architraves	25
4.10	Fillets and bond breakers — bond breaker installation for bonded membranes	28
4.11	Junctions, transitions, and terminations	29
4.11.1	Types of junctions, transitions, and terminations	29
4.11.2	Vertical flashing for shower wall junctions	30
4.12	Penetrations	30
4.12.1	Shower areas	30
4.12.2	Horizontal surface taps	31
4.12.3	Other penetrations in Category 1 areas	31
4.12.4	Niches, inlaid soap holders, and footrests	31
4.13	Baths and spas	32
4.13.1	General	32
4.13.2	Baths without showers over them	32
4.13.3	Baths with showers over them	35
4.13.4	Freestanding baths	38
4.13.5	Bath end walls abutting a shower	38
4.13.6	Spa baths	38
4.14	Preformed shower bases	39
4.15	Enclosed shower screen placement	41
4.15.1	Showers with hobs	41
4.15.2	Showers with step-downs	41
4.15.3	Showers without hobs or step-downs	41
4.15.4	Bath end walls and nib walls abutting a shower	42
4.16	Vinyl	42
4.17	Polished concrete	45
4.18	Floor heating	45
<b>Appendix A (informative) Design considerations in wet-area waterproofing</b>		<b>46</b>
<b>Appendix B (informative) Falls in floor finishes</b>		<b>54</b>
<b>Appendix C (normative) Membrane continuity testing</b>		<b>55</b>
<b>Appendix D (informative) Suggested installation checklist</b>		<b>57</b>
<b>Appendix E (informative) Compatibility</b>		<b>59</b>
<b>Appendix F (informative) Testing for moisture content in subfloors</b>		<b>62</b>
<b>Bibliography</b>		<b>65</b>

# Australian Standard®

## Waterproofing of domestic wet areas

### Section 1 Scope and general

#### 1.1 Scope

This document sets out minimum requirements for the materials, design and installation of waterproofing for domestic wet areas.

This document applies to internal wet areas as defined in the National Construction Code (NCC).

NOTE 1 [Appendix A](#) provides design considerations for categories of wet area waterproofing.

The following are excluded from the scope of this document:

- (a) Situations where flooding of the wet areas occurs through overflowing of vessels or plumbing failures.
- (b) Concrete admixtures or penetrant sealers or similar.
- (c) Decorative coatings.
- (d) Communal or group wet areas such as shower areas as in swimming pool complexes, sporting facilities, steam rooms, and similar situations.

NOTE 2 A suggested checklist of items to be reviewed following installation of waterproofing is provided in [Appendix D](#).

NOTE 3 A method to determine whether the subfloor moisture content is suitable for the installation of waterproof membranes is provided in [Appendix F](#).

#### 1.2 Normative references

The following documents are referred to in the text in such a way that some or all of their contents constitutes requirements of this document:

NOTE Documents referenced for informative purposes are listed in the Bibliography.

AS 1288, *Glass in buildings—Selection and Installation*

AS 1566, *Copper and copper alloys—Rolled flat products*

AS 1684.2, *Residential timber-framed construction, Part 2: Non-cyclonic areas*

AS 1684.3, *Residential timber-framed construction, Part 3: Cyclonic areas*

AS 1684.4, *Residential timber-framed construction, Part 4: Simplified—Non-cyclonic areas*

AS 1884, *Floor coverings—Resilient sheet and tiles—Installation practices*

AS 2870, *Residential slabs and footings*

AS 3500.2, *Plumbing and drainage, Part 2: Sanitary plumbing and drainage*

AS 3588, *Shower bases and shower modules*

AS 3600, *Concrete structures*

AS 3700, *Masonry structures*

AS/NZS 1170.1, *Structural design actions, Part 1: Permanent, imposed and other actions*

AS/NZS 1170.2, *Structural design actions, Part 2: Wind actions*

AS/NZS 2269 (all parts), *Plywood—Structural*

AS/NZS 2588, *Gypsum plasterboard*

AS/NZS 2908.2, *Cellulose-cement products, Part 2: Flat sheets*

AS/NZS 2924.1, *High pressure decorative laminates—Sheets made from thermosetting resins, Part 1: Classification and specifications*

AS/NZS 4858, *Wet area membranes*

### 1.3 Terms and definitions

For the purposes of this document, the following terms and definitions apply.

#### 1.3.1

##### **backing rod**

section of closed cell foam made from polyethylene or similar suitable product

#### 1.3.2

##### **bond breaker**

system that prevents the membrane bonding to the substrate, bedding or lining in order to dissipate the shear forces that may otherwise cause failure of the membrane

Note 1 to entry: This may include proprietary transition tapes when used in accordance with the product specifications.

#### 1.3.3

##### **dry film thickness**

##### **DFT**

measurement of thickness of a coating remaining on the surface after full cure of the coating

#### 1.3.4

##### **competent person**

person who has acquired, through education, training, qualification or experience or a combination of these, the knowledge and skill enabling that person to perform the task required

#### 1.3.5

##### **efflorescence**

accumulation of calcium and/or other soluble salts that stains or etches surface finishes after evaporation of the solvent (water)

Note 1 to entry: Typically, cement-based installation materials may provide the initial source of soluble salts.

#### 1.3.6

##### **fall**

difference in level over a given length in the direction of flow

Note 1 to entry: Commonly expressed as the ratio or percentage of unit rise to horizontal distance.

#### 1.3.7

##### **flashing**

strip or sleeve of impervious material dressed, fitted or built-in to provide a barrier to moisture movement, or to divert the travel of moisture, or to cover a joint where water would otherwise penetrate between wet and dry areas

#### 1.3.8

##### **flashing, perimeter**

flashing used at the floor-wall junction

**1.3.9****flashing, vertical**

flashing used at wall junctions within wet areas

**1.3.10****floor waste**

grated inlet within a floor intended to drain the floor surface

**1.3.11****full cure stage**

stage of curing at which the product is cured for service

Note 1 to entry: This may include components such as membranes, primers, sealants, and other materials requiring curing.

**1.3.12****hob**

upstand at the perimeter of a shower area

**1.3.13****insert bath**

bath where the bath lip is installed onto a horizontal plinth or surface

**1.3.14****leak control flange**

flange connected to a waste pipe, at the point at which it passes through the floor substrate

Note 1 to entry: Intended to prevent leakage and enable tile bed drainage into the waste pipe and connection of waterproofing membrane into the waste pipe.

**1.3.15****linear drain**

longitudinal floor waste containing a channel, waste outlet, and grating

Note 1 to entry: Also known as shower channel, strip grate.

**1.3.16****maximum retained water level**

point at which surface water will start to overflow out of the shower area

**1.3.17****may**

indicates the existence of an option

**1.3.18****membrane**

barrier that is impervious to moisture

Note 1 to entry: A barrier may be a single or multi-part system.

**1.3.19****membrane states**

stages of curing

Note 1 to entry: See also [1.3.26](#) recoat stage, [1.3.23](#) overlay stage, [1.3.11](#) full cure stage.

**1.3.20****membrane, external**

membrane that is installed behind the wall sheeting or render

Note 1 to entry: Usually external membranes are preformed trays or sheet material systems.

**1.3.21  
membrane, internal**

membrane that is installed to the face of the wall sheeting or render

Note 1 to entry: Usually internal membranes are liquid systems or bonded sheet systems applied *in situ*.

**1.3.22  
nib wall that forms part of shower enclosure**

low height wall that supports part of a shower screen

**1.3.23  
overlay stage**

stage of curing which allows installation of overlay materials

Note 1 to entry: This may include components such as membranes, primers, sealants, and other materials requiring curing.

**1.3.24  
prefinished wall panels**

pre-decorated sheets or thermosetting laminated sheets that are designed for use as the final wall finish of the wet area

**1.3.25  
preformed shower base**

preformed, prefinished vessel (including integral upstands) installed as the finished floor of a shower compartment, and provided with a connection point to a sanitary drainage system

Note 1 to entry: Shower bases are commonly made of plastics, composite materials, vitreous enamelled pressed steel, or stainless steel.

**1.3.26  
recoat stage**

stage of curing which allows application of further coats

Note 1 to entry: This may include components such as membranes, primers, sealants, and other materials requiring curing.

**1.3.27  
screed**

layer of material, usually cement based, which sets *in situ* and which may be interposed between the structural base and the bedded finish

**1.3.28  
shall**

indicates that a statement is mandatory

**1.3.29  
should**

indicates a recommendation

**1.3.30  
shower area**

area directly affected by water from a shower, including a shower over a bath

**1.3.31  
shower area, enclosed**

area enclosed by walls, screens, hinged or sliding doors, that control the spread of water to within the Category 1 area

**1.3.32****shower area, unenclosed**

shower area where, under normal use, water out of the shower rose is not contained within the shower area

**1.3.33****shower screen**

panels, doors or glazing system enclosing or partially enclosing a shower area

**1.3.34****shower tray**

internal or external liquid or sheet membrane system used to waterproof the floor and the wall/floor junctions of a shower area

**1.3.35****substrate**

surface to which the membrane is applied

**1.3.36****underlayment**

smoothing compound or a cementitious levelling compound

[SOURCE: AS 1884:2021, 1.3.47]

**1.3.37****vessel**

open, preformed, prefinished concave receptacle capable of holding water, usually for the purpose of washing, including a basin, sink, bath, laundry tub and the like

**1.3.38****waste pipe riser**

waste pipe between the drainage flange and the drainage system

**1.3.39****water resistant****WR**

property of a system or material that restricts moisture movement and will not degrade under conditions of moisture

**1.3.40****waterproof****WP**

property of a material that does not allow moisture to penetrate through it

**1.3.41****waterproofing system**

combination of elements that are required to achieve a waterproof barrier as required by this document

Note 1 to entry: For example, substrate, membrane, bond breakers, waterstops, sealants and finishes.

**1.3.42****waterstop**

vertical extension of the waterproofing system forming a barrier to prevent the passage of moisture in the floor or vertically in a wall

Note 1 to entry: This includes hobs, nib walls, door angles, and any other vertical barrier that forms an integral part of the waterproofing system.

**1.3.43****wet area**

within a building, an area supplied with water from a water supply system, which includes bathrooms, showers, laundries and sanitary compartments and excludes kitchens, bar areas, kitchenettes or domestic food and beverage preparation areas

**1.3.44****wet film thickness****WFT**

measurement of the thickness of a freshly applied liquid material

Note 1 to entry: Usually a liquid-application of a waterproof-membrane material, during the application process so as to ascertain the depth of applied material.

**1.3.45****wet film thickness gauge****notched gauge**

metal or plastic card that is designed to measure wet film thickness (WFT)

Note 1 to entry: These gauges may also commonly be known as: Combs, MIL Gauges, Step Gauges and Notched Gauges. The gauges incorporate a series of notches cut into their sides, similar to the teeth on a comb with progressive height differences relating to an incorporated scale to each notch that indicates the depth of wet material when set at the substrate level. They may be used to measure WFT of most coatings including paints, resins, liquid applied membranes, etc.

## Section 2 Design

### 2.1 Design principles

#### 2.1.1 General

Water shall be retained in a Category 1 area for an enclosed or unenclosed shower.

NOTE 1 For classification of categories of risk for wet areas, see [Appendix A](#).

Where a floor waste is required in a shower area or wet area, water shall drain to that floor waste.

In a Category 2 area, the extent of waterproofing shall be a distance of a minimum of 1 500 mm from the substrate connection of the shower rose. See [Clause 4.8.2](#) for waterstop requirements.

NOTE 2 Movement joints (vertical articulation joints), in floors and walls should not affect the integrity of the wet area.

NOTE 3 The design should consider minimizing causes of efflorescence. See [Clause A.5.5.2](#) for more information.

#### 2.1.2 Material selection

Waterproofing systems and their installation details shall be compatible with each other and shall resist the following:

- (a) Differential movement due to —
  - (i) actions as defined in AS/NZS 1170.1 and AS/NZS 1170.2;
  - (ii) shrinkage and expansion of substrate materials, framing and finishes;
  - (iii) temperature variations from  $-5^{\circ}\text{C}$  to  $+50^{\circ}\text{C}$ ; and
  - (iv) movement tolerances as defined in AS 2870.

NOTE For suitability of sheet fastening systems refer to the product specifications.

- (b) Exposure to —
  - (i) cleaning chemicals as required by AS/NZS 4858; and
  - (ii) alkalis from cement mortar as required by AS/NZS 4858.

### 2.2 Shower classification

#### 2.2.1 Enclosed showers

For an enclosed shower, the shower screen shall be designed and installed to prevent the spread of water from the Category 1 area.

#### 2.2.2 Unenclosed showers

##### 2.2.2.1 General

An unenclosed shower shall include —

- (a) Type 1 —
  - (i) a frameless shower screen, unless the shower screen is fitted with seals and deflectors, all of which control the spread of water from the shower area; or

- (ii) a shower over bath with up to 900 mm fixed glass screen.
- (b) Type 2 —
- (i) a shower area with a curtain;
  - (ii) a shower over bath with curtain;
  - (iii) a shower area with no curtain; or
  - (iv) an area where a shower screen partitions one side of the shower, the entry to the shower is open, and the spray from the rose can still exit the shower past the screen 1 500 mm.

An unenclosed shower shall not adjoin a Category 3 area.

NOTE Unenclosed shower areas are not suitable for use directly adjacent to exits to wet areas. See [Clause 4.8.5](#) for requirements relating to showers located near exits to wet areas.

## 2.3 Requirements for fall

### 2.3.1 Falls in substrate

Where a floor waste is required in a wet area, the membrane shall be applied to a substrate with a minimum 1:100 fall towards the floor waste.

NOTE This requirement is intended to avoid ponding on the substrate.

### 2.3.2 Falls in shower area floor finishes (Category 1)

The fall to the floor waste in a shower area shall be a minimum of 1:80.

NOTE See [Appendix B](#) for additional information regarding falls in floor finishes.

### 2.3.3 Falls in wet area floor finishes adjacent to shower area where there is a floor waste (Category 2)

Where a required floor waste is installed adjacent to a shower area, the minimum fall to the waste shall be 1:100.

NOTE Surface water should drain to the waste. Water should not exit the wet area at doorway thresholds under normal use. Where surface falls are provided in Category 2 areas to a Category 1 shower waste, the whole of the Category 2 floor area should have falls provided.

### 2.3.4 Falls in wet area floor finishes where there is no floor waste (Category 3)

The shower shall be an enclosed shower. There is no requirement for fall in the Category 3 area.

Water shall be retained within the wet area.

NOTE 1 Water retention may be achieved by localized falls away from doors.

NOTE 2 See [Appendix B](#) for information on falls in floor finishes.

NOTE 3 For information on the laying of tiles to enable them to drain without retaining water, refer to AS 3958.1.

### 2.3.5 Whole of bathroom designed as an unenclosed shower

In a whole bathroom designed as an unenclosed shower without a shower screen installed, the floor substrate under the membrane shall have a minimum 1:80 fall.

NOTE 1 If a screed is used, the membrane should be applied on top of the screed.

NOTE 2 For further information on accessible bathrooms, refer to AS 1428.1.

## Section 3 Materials

### 3.1 Scope of section

This section sets out requirements for acceptable materials to be used in the waterproofing of wet areas.

### 3.2 Compatibility

Components throughout the entire waterproofing system shall be compatible.

NOTE Consideration should be given to the interface between substrates, primers, sealants, membranes, and overlays. See [Appendix E](#) for further information.

### 3.3 Materials

#### 3.3.1 Waterproof

The following materials used in waterproofing systems are deemed to be waterproof:

- (a) Stainless steel.
- (b) Copper, material not less than 99.9 % copper, in accordance with the requirements for material designation 110 or 122 given in AS 1566.
- (c) Flexible waterproof sheet flooring material with sealed and welded joints, meeting the requirements of AS/NZS 4858.

NOTE 1 There is no need for a waterstop at the general room doorway when using this material.

- (d) Wet area membranes meeting the requirements of AS/NZS 4858.
- (e) Glass meeting the requirements of AS 1288.
- (f) Polyvinylchloride (PVC) meeting the requirements of AS 3500.2.

NOTE 2 For the design and installation criteria of waterproofing systems, see [Sections 2](#) and [4](#), respectively.

#### 3.3.2 Water-resistant substrates

For the purposes of this Standard, the following materials used in waterproofing systems, in conjunction with water-resistant surface materials in accordance with [Clause 3.3.3](#), are deemed to be water resistant:

- (a) Walls:
  - (i) Concrete in accordance with AS 3600.
  - (ii) Cement render.
  - (iii) Fibre cement sheeting manufactured in accordance with AS/NZS 2908.2.
  - (iv) Water-resistant plasterboard sheeting manufactured in accordance with AS/NZS 2588.
  - (v) Masonry in accordance with AS 3700.

- (vi) Structural plywood manufactured in accordance with AS/NZS 2269 (series), and installed in accordance with AS 1684.2, AS 1684.3 and AS 1684.4.
- (b) Floors:
  - (i) Concrete in accordance with AS 3600 and AS 2870.
  - (ii) Compressed fibre cement sheeting manufactured in accordance with AS/NZS 2908.2.
  - (iii) Fibre cement sheeting manufactured in accordance with AS 2908.2, and supported on a structural floor.
  - (iv) Structural plywood manufactured in accordance with AS/NZS 2269 (series), and installed in accordance with AS 1684.2, AS 1684.3 and AS 1684.4.

The substrate material shall not degrade when exposed to moisture.

### 3.3.3 Water-resistant surface materials

The following surface materials are deemed to be water resistant for the locations listed:

- (a) Walls:
  - (i) Thermosetting laminated sheet manufactured in accordance with AS/NZS 2924.1.
  - (ii) Pre-decorated fibre cement sheeting manufactured in accordance with AS/NZS 2908.2.
  - (iii) Ceramic and stone tiles when used in conjunction with a substrate addressed in [Clause 3.3.2](#).
  - (iv) Water-resistant flexible sheet wall material with sealed joints (e.g. sheet vinyl) when used in conjunction with a substrate addressed in [Clause 3.3.2](#).
  - (v) Sanitary grade acrylic or polymer wall linings.
  - (vi) Glass materials in accordance with AS 1288.
- (b) Floors (when used in conjunction with a substrate addressed in [Clause 3.3.2](#)):
  - (i) Ceramic and stone tiles.
 

NOTE Porous tiles can have discolouration caused by water absorption and migration.
  - (ii) Water-resistant flexible sheet flooring material with sealed joints (e.g. sheet vinyl) in accordance with AS 1884.
  - (iii) Concrete.

### 3.4 Preformed, prefinished shower bases and enclosures

Resin-based substrates and finishes, materials used in the manufacture of preformed, prefinished shower bases and enclosures shall be such that the finished product is waterproof and is in accordance with AS 3588.

NOTE Typical materials used are, but not limited to, fibreglass, glass, ceramic, aluminium and steel.

### 3.5 Sealants

All sealants shall be —

- (a) waterproof or water resistant and used as required in [Clause 4.11.1](#);

- (b) flexible;
- (c) mould-resistant; and
- (d) compatible with adjacent materials.

### 3.6 Fastenings for substrate sheet linings

Sheet fastening spacings shall be compatible with the waterproofing system. Sheet fastening spacings shall not compromise the waterproofing system.

Requirements for sheet fastening systems are as follows:

- (a) *Water-resistant plasterboard sheets* — Systems for fixing water-resistant plasterboard shall be compatible with the sheet to be fastened.
- (b) *Fibre cement sheets* — Screws for fixing fibre-reinforced cement sheets shall be compatible with the sheet to be fastened.

NOTE For suitability of sheet fastening systems refer to product specifications.

### 3.7 Adhesives

Adhesives used in a waterproofing system shall be —

- (a) waterproof in accordance with AS/NZS 4858, where waterproof to waterproof materials meet; and

NOTE 1 This is particularly important at the laps of sheet membranes.

- (b) compatible with the materials to which they are adhered.

NOTE 2 For example, ceramic and stone tile adhesives would be required to be water resistant to bond tiles to a waterproof or water-resistant surface.

## Section 4 Installation

### 4.1 Scope of section

This section sets out details for the installation of waterproof and water-resistant materials to be used in domestic wet areas of a building.

### 4.2 Membrane installation for tile bed or screed

Where a tile bed or screed is used, the waterproof membrane shall be installed above or below the tile bed or screed.

NOTE 1 Some figures in this section illustrate the membrane below the tile bed or screed; however, where applicable, the membrane may be installed above the tile bed or screed.

NOTE 2 The figures in this document show the membrane applied to flat substrates for illustrative purposes only, and are not intended to replace the provisions of [Clause 2.3.1](#).

### 4.3 Membrane to drainage connection

#### 4.3.1 Leak control flanges

For a membrane to drainage connection, the following shall apply:

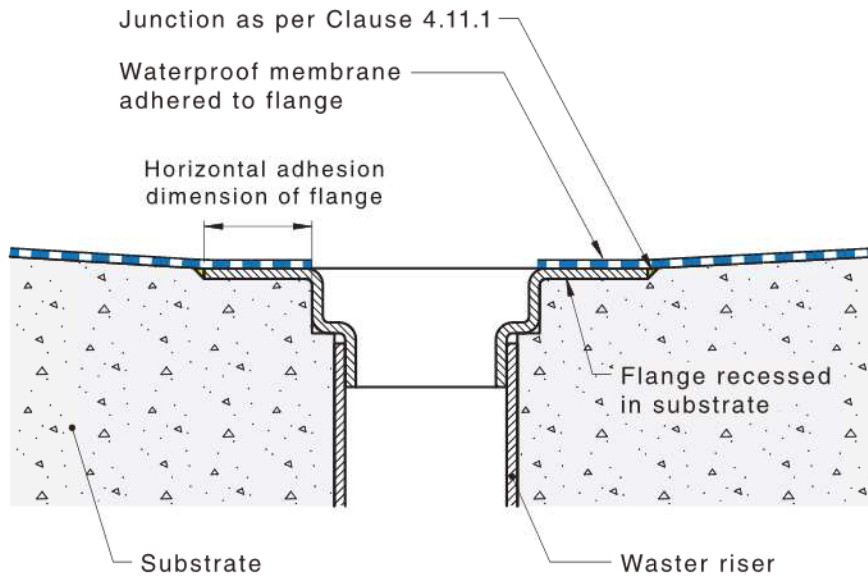
- (a) The waterproofing membrane shall be bonded onto the leak control flange. The membrane shall be terminated horizontally or both horizontally and vertically.

NOTE 1 For information regarding selection and installation of leak control flanges, refer to membrane product specifications.

NOTE 2 For typical examples of membrane terminations at drainage outlets, see [Figure 4.3.1\(A\)](#) and [Figure 4.3.1\(B\)](#).

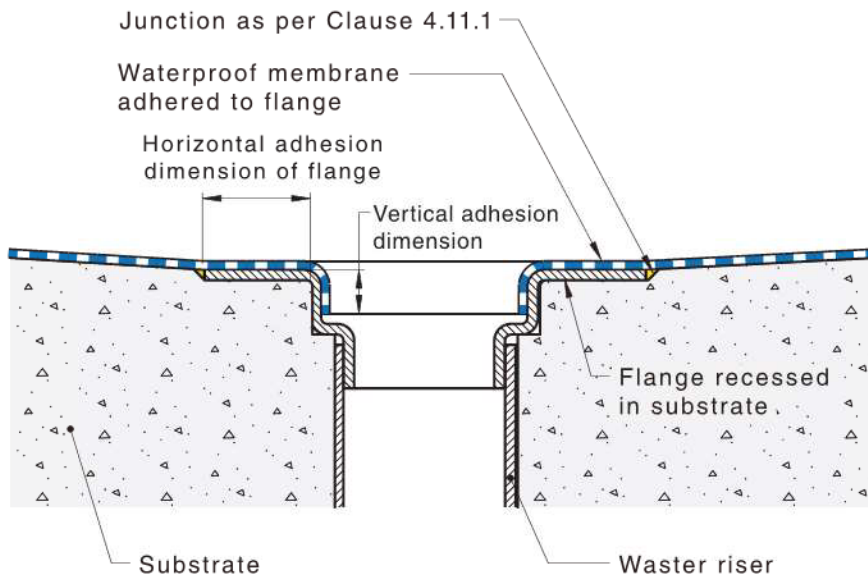
- (b) Leak control flanges shall be recessed into the substrate and not protrude above it. Leak control flanges shall be sealed to the riser and be secured to the substrate to prevent movement. The diameter of the leak control flange (DN) shall match the diameter of the riser pipe (DN). The transition from leak control flange to substrate shall have a fillet sealant applied.
- (c) Where a shower tray is used, provision shall be made to drain the tile bed and provide a waterproof connection to the drain.
- (d) The leak control flange shall not be installed in a location that interferes with bond breakers or wall floor junctions.

NOTE 3 For an example of a generic leak control flange adjacent to a wall, see [Figure 4.3.1\(C\)](#).



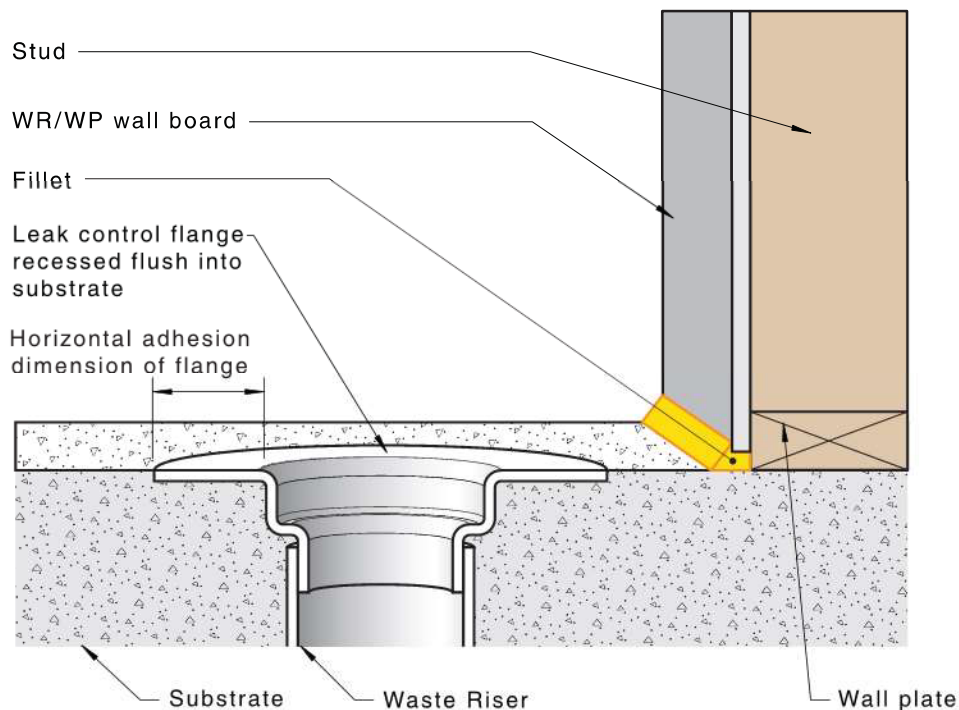
**Figure 4.3.1(A) — Typical membrane termination at leak control flange**

[SOURCE: Reproduced with permission from Stormtech. All rights reserved]



**Figure 4.3.1(B) — Typical membrane termination at leak control flange with down leg**

[SOURCE: Reproduced with permission from Stormtech. All rights reserved]



**Figure 4.3.1(C) — Generic leak control flange adjacent to a wall**

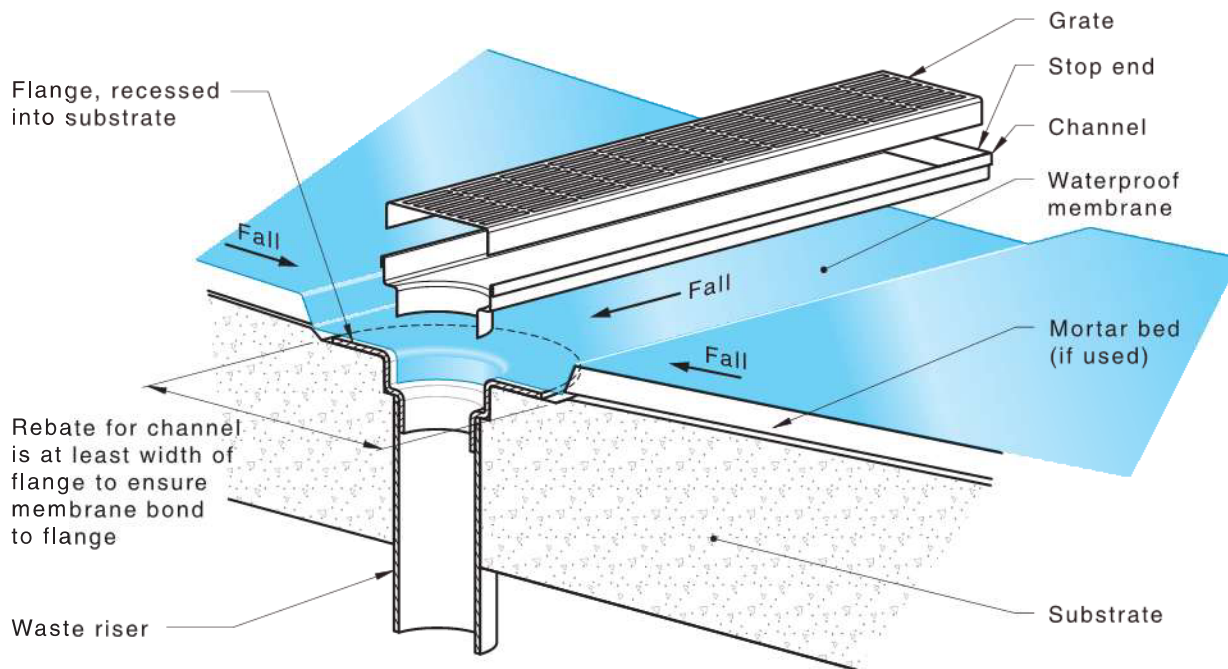
[SOURCE: Reproduced with permission from Stormtech. All rights reserved]

### 4.3.2 Linear drainage connections

The waterproof drainage shall be continuous for the membrane into the drainage outlet. Where the drainage channel does not have an integral horizontal or vertical surface of 50 mm for termination of the membrane, the membrane shall be continuous underneath the drainage channel, terminating at a recessed leak control flange.

When the drainage channels without integral flanges are installed against a wall, the installation shall conform to the waterproofing requirements of [Clause 4.6.3](#).

NOTE See [Figure 4.3.2](#) for an example of a linear drain with a centrally located single outlet.



NOTE Trim should not restrict substrate drainage at linear drain.

**Figure 4.3.2 — Linear drain single outlet centrally located**

[SOURCE: Reproduced with permission from Stormtech. All rights reserved]

## 4.4 Surface preparation

### 4.4.1 Surface preparation

The preparation of the substrate for membranes shall result in the surface of the substrate being smooth, without protrusions, voids or formwork distortions, and clean, dry, and free from dust and contamination.

Substrates shall be treated in order to eliminate pin-holing caused by substrate degassing during the wet film curing process, and for adhesion to the substrate.

NOTE 1 To aid in adhesion on a concrete or screeded surface, the smoothness of substrate should be at least the equivalent to that of a wood float or light broom finish. Priming may be required for some types of membrane.

NOTE 2 Refer to product specifications for guidance on appropriate treatments.

NOTE 3 All surfaces to which a waterproofing system is to be applied should be treated to improve adhesion of the membrane, with particular emphasis on liquid waterproofing systems. Cured materials should be well bonded to the substrate to prevent subsequent failure through shear, cyclical or elongation stress.

NOTE 4 Surface irregularities may be addressed by grinding, shot blasting, scarification, localized filling, self-levelling topping or any other mechanical means deemed appropriate. The importance of surface irregularities is reflected in the use of a standardized measure of concrete surface roughness known as the Concrete Surface Profile (CSP). For more information regarding CSP, refer to Appendix E of AS 1884:2021.

### 4.4.2 Requirements for fall in substrate

Falls in membrane substrate shall be as per the design requirements in [Clause 2.3.1](#).

#### 4.4.3 Moisture content of substrates

The moisture content in a substrate shall be:

- (a) measured prior to membrane application; and
- (b) suitable for the particular membrane system to be used.

NOTE 1 Excessive residual moisture in a substrate may prevent full curing of the membrane system or may cause the membrane to prematurely fail. Further information on the suitability of a membrane system can be found in the product specifications.

NOTE 2 Strategies to mitigate higher RH percentage levels in the substrate include application of a moisture barrier.

NOTE 3 For guidance on testing for moisture content in subfloors, see [Appendix F](#).

#### 4.4.4 Wall sheeting preparation

Substrate sheet materials shall be mechanically fastened to the supporting structure.

NOTE 1 Substrate sheet materials should be installed in accordance with the manufacturer's instructions.

NOTE 2 Setting materials should be water resistant.

NOTE 3 Setting materials should not de-bond or de-laminate.

NOTE 4 It is recommended that fibre cement sheeting be a minimum of 6 mm.

NOTE 5 All free edges of sheet materials should be supported.

#### 4.4.5 Render preparation

The surface of the render shall be smooth and uniform.

NOTE Guidance on rendering is provided in AS 3958.1.

### 4.5 Membrane application

#### 4.5.1 Installation of an external membrane

Where an external membrane is installed, it shall meet the following conditions:

- (a) The top edges of the membrane shall be fixed to the wall.
- (b) Fixing penetrations shall be a minimum of 100 mm above the finished tile level of the shower area.
- (c) All fixings shall be compatible with the membrane.
- (d) All fixings shall be non-corrosive.

#### 4.5.2 Curing of membranes

All membranes shall be cured to overlay stage before the overlaying finishes are applied.

Where flood testing is being conducted, the membrane shall be cured to full cure stage prior to testing or any other exposure to moisture.

NOTE 1 Curing requirements are influenced by drying times, re-coating, water testing times and tile adhesive applications.

NOTE 2 Curing times of membranes are critical to their durability and are dependent on —

- (a) the chemical composition of the materials used (e.g. polyurethanes, acrylics, etc.);
- (b) the solid's content;
- (c) site conditions (e.g. wind, temperature and relative humidity);
- (d) ventilation conditions;
- (e) coating thicknesses; and
- (f) substrate conditions (temperature and moisture content).

#### 4.5.3 Membrane inspection

A visual inspection shall be conducted prior to installation of any overlaying finish in order to ensure the integrity of the membrane.

NOTE The purpose of the visual inspection is to check for continuity of the membrane, and any obvious installation defects such as pinholes, dry film thickness, adequacy of fillets, transitions, bonding, and vertical termination heights, location and adequacy of waterstops.

#### 4.5.4 Additional continuity testing

Additional membrane continuity testing may be carried out. Where testing is carried out in accordance with [Appendix C](#), the following shall apply:

- (a) Flood testing in accordance with [Clause C.2](#).

NOTE 1 Where any leakage is identified, this should be repaired in a manner consistent with the system design. Following the completion of the repairs and curing of materials, the area should be retested.

- (b) The electronic leak detection test in accordance with [Clause C.3](#).

NOTE 2 Where any discontinuities are found in the lining, all defective areas should be repaired and retesting should only be carried out on those repaired areas.

NOTE 3 The entire lining should only be tested once.

- (c) The seam probe test in accordance with [Clause C.4](#).

NOTE 4 Where any seam failures are identified, these should be repaired and the area re-tested following repair.

NOTE 5 Dry film thickness (DFT) should be measured and recorded at overlay stage prior to installation of an overlaying finish.

NOTE 6 Dry film thickness may be measured non-destructively using an ultrasonic film thickness gauge, or destructively.

NOTE 7 The minimum DFT should be achieved before overlaying or tiling. For minimum DFT refer to the manufacturer's data sheet.

NOTE 8 It is advisable to regularly check the wet film thickness during application of the membrane using a notched gauge that is pressed into the wet membrane. Application rates should be adjusted to ensure the WFT will achieve the minimum DFT on full cure.

NOTE 9 The recommended frequency of measurements should be as follows where practical:

- (a) Category 1 areas: four measurements per square metre.
- (b) Category 2 and 3 areas: one measurement per square metre.

This note does not give rise to a requirement for this level of testing.

## 4.6 Membrane termination

### 4.6.1 Termination of membranes at shower recess waterstops

Termination of membranes to waterstop angles shall be bonded as per a Type 1 junction according to [Clause 4.11.1](#).

Waterstop termination for unenclosed showers shall be flush with finished floor level as per [Clause 4.8.1](#).

Waterstop termination for hobless enclosed, or set down showers shall finish a minimum of 5 mm above finished floor level of the outer floor as per [Clause 4.8.3](#).

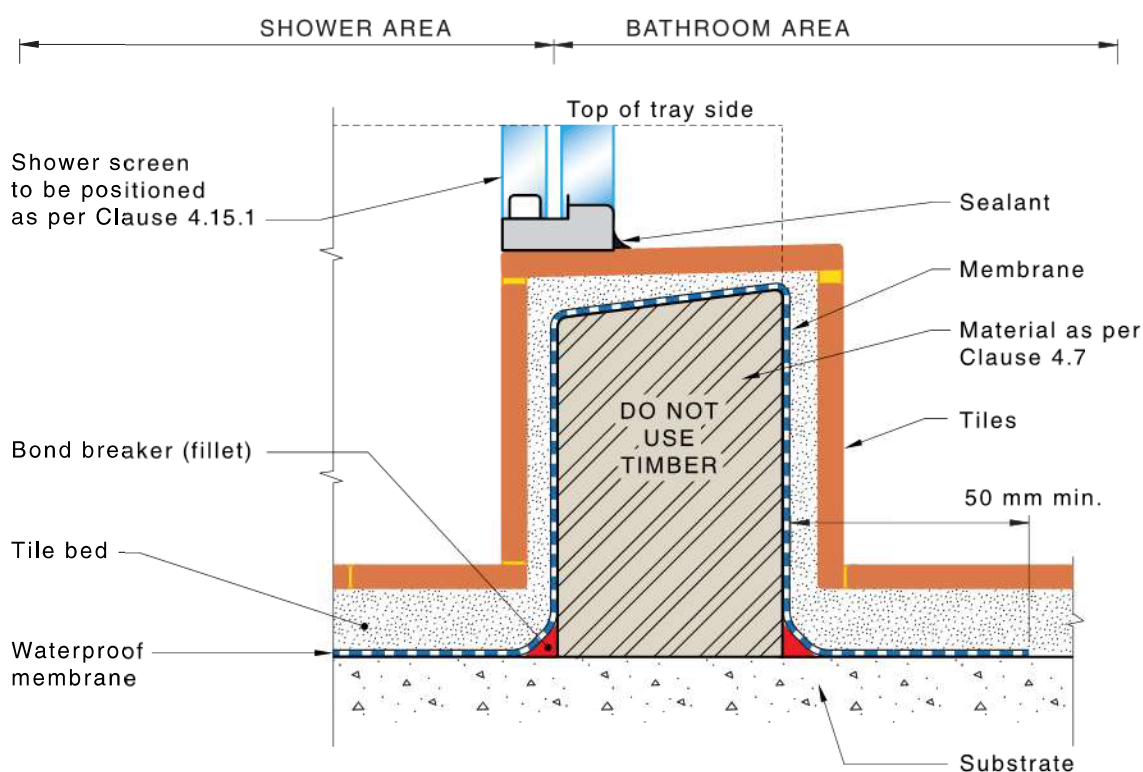
### 4.6.2 Termination of membranes at showers with hobs

For hobs not consisting of metal angles, the membrane shall be brought up over the top of the hob, down the outside face and terminate a minimum 50 mm onto the floor.

NOTE For a typical application, see [Figure 4.6.2](#).

For metal angle hobs, the membrane shall be terminated within 5 mm from the top of the angle, and any gap between the shower screen and the angle shall be filled with a sealant.

The extent of the membrane for an internal shower tray shall be as shown in [Figure 4.6.2](#).



NOTE 1 The area outside the shower area should be designed as a Category 3.

NOTE 2 If the area outside the shower area is a Category 2 wet area, consideration should be given to extending the membrane across the whole of the floor.

**Figure 4.6.2 — Shower with a hob liquid membrane**

### 4.6.3 Vertical membrane termination

The membrane shall be applied over the floor substrate and up the vertical face of the wall —

- (a) for showers with a hob or step-down, a minimum height of 150 mm above the finished tile level of the floor or 25 mm above the maximum retained water level, whichever is the greater;
- (b) for hobless showers, a minimum height of 150 mm above the highest finished tile level of the floor within the shower area;
- (c) for waterproofing in shower areas, it shall be applied to the junctions and terminate 1 800 mm above the finished floor level or 50 mm above the shower rose, whichever is the higher as per [Clause 4.11.2](#); and
- (d) where a shower rose is ceiling mounted, it shall be applied to the junctions and terminate to the full height of the wall with a Type 3 junction as per [Clause 4.11.1](#).

### 4.7 Hob construction

Hobs shall be constructed of water-resistant material such as masonry, concrete, or corrosion-resistant metal. Autoclaved aerated concrete may be used with internal membrane systems. Where used, autoclaved aerated concrete shall be primed before the application of the membrane.

All gaps, joints and intersections of the hob shall be made flush before application of the membrane. The hobs shall be secured to the floor and sealed against the wall prior to applying an internal membrane.

The top of the hob shall have a fall towards the shower enclosure.

Timber shall not be used for hob construction.

### 4.8 Waterstops

#### 4.8.1 General

Waterstops shall be installed to retain water within the shower area or wet area. Waterstops are an integral part of the waterproofing system and shall conform with [Clauses 4.8](#) and [4.9](#).

#### 4.8.2 Waterstop for unenclosed showers

An unenclosed shower shall incorporate a waterstop finishing at the perimeter of the shower area.

This clause sets out requirements for waterstops according to the type of unenclosed shower (see [Clause 2.2.2.1](#)) as follows:

- (a) *Type 1 unenclosed showers* — A waterstop shall be placed under the splash restriction device and across the opening of the shower of a Type 1 shower screen.

NOTE 1 It is advisable to have either the screed drained, or a membrane placed on the top of the screed to prevent water retention in the screed beyond the waterstop.

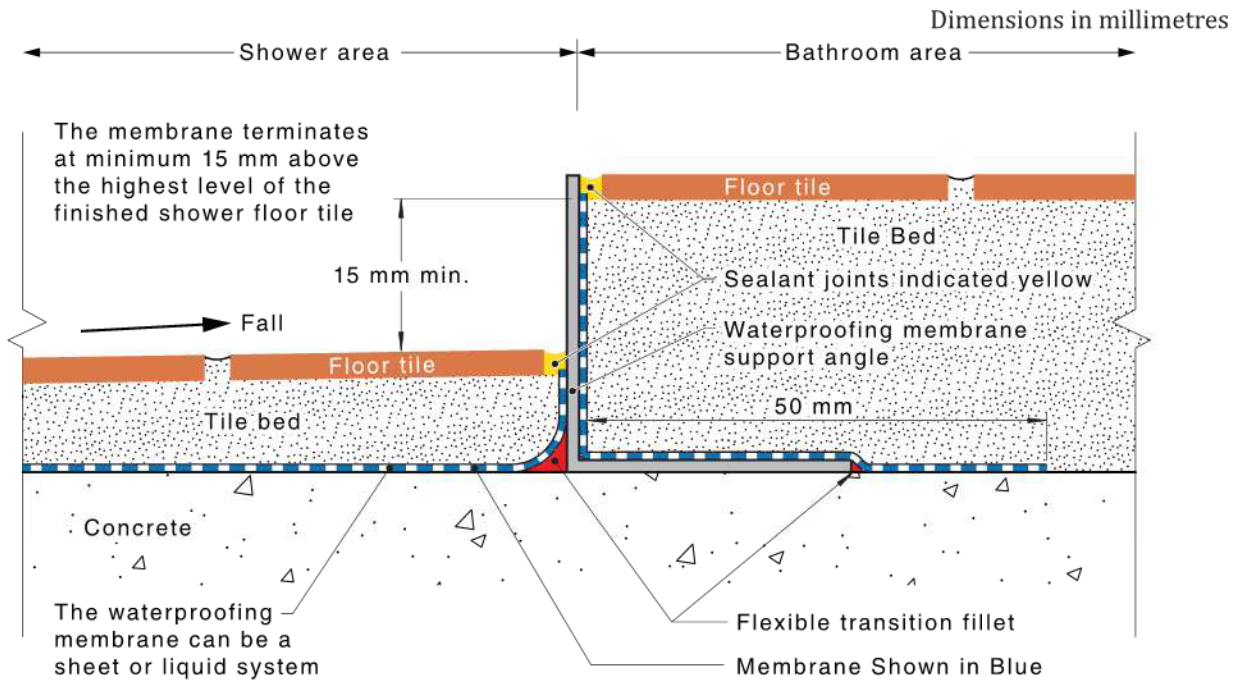
NOTE 2 Type 1 unenclosed showers have a device that will restrict splashing during use.

- (b) *Type 2 unenclosed showers* — The waterstop of a Type 2 shower shall be a minimum of 1 500 mm from the shower rose connection to the wall or the ceiling.

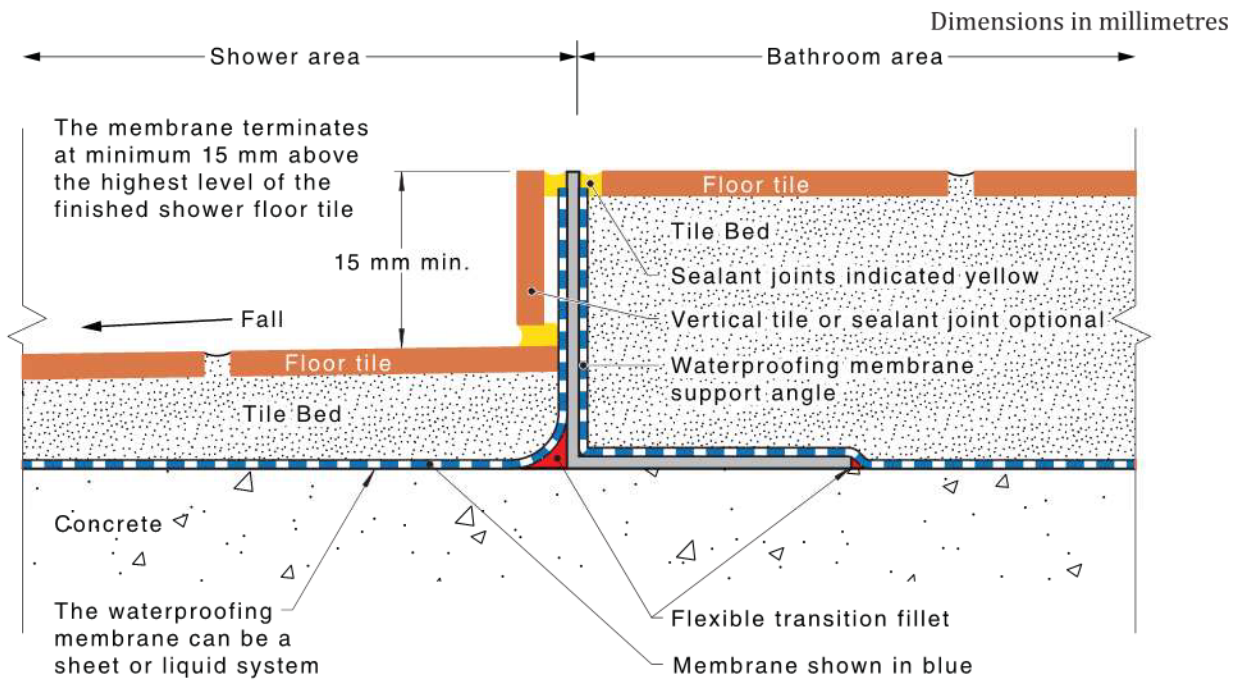
NOTE 3 See [Figure 4.8.2\(A\)](#) for an example of a Type 2 unenclosed shower.

NOTE 4 If using the waterstop at the door threshold for a Type 2 unenclosed shower see [Clause 2.3.5](#).

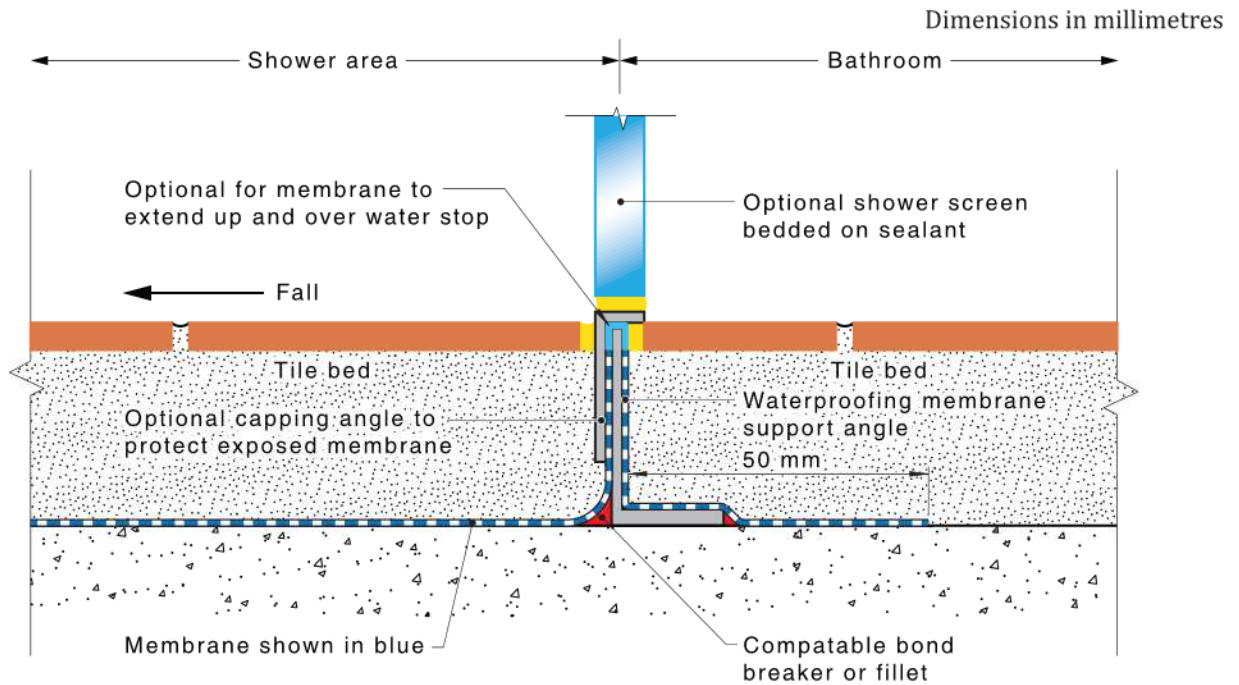




**Figure 4.8.2(B) — Step-down shower waterstop and cover channel liquid membrane**



**Figure 4.8.2(C) — Step-down shower waterstop and cover angle**



**Figure 4.8.2(D) — Shower waterstop and cover angle**

#### 4.8.3 Waterstops for enclosed showers

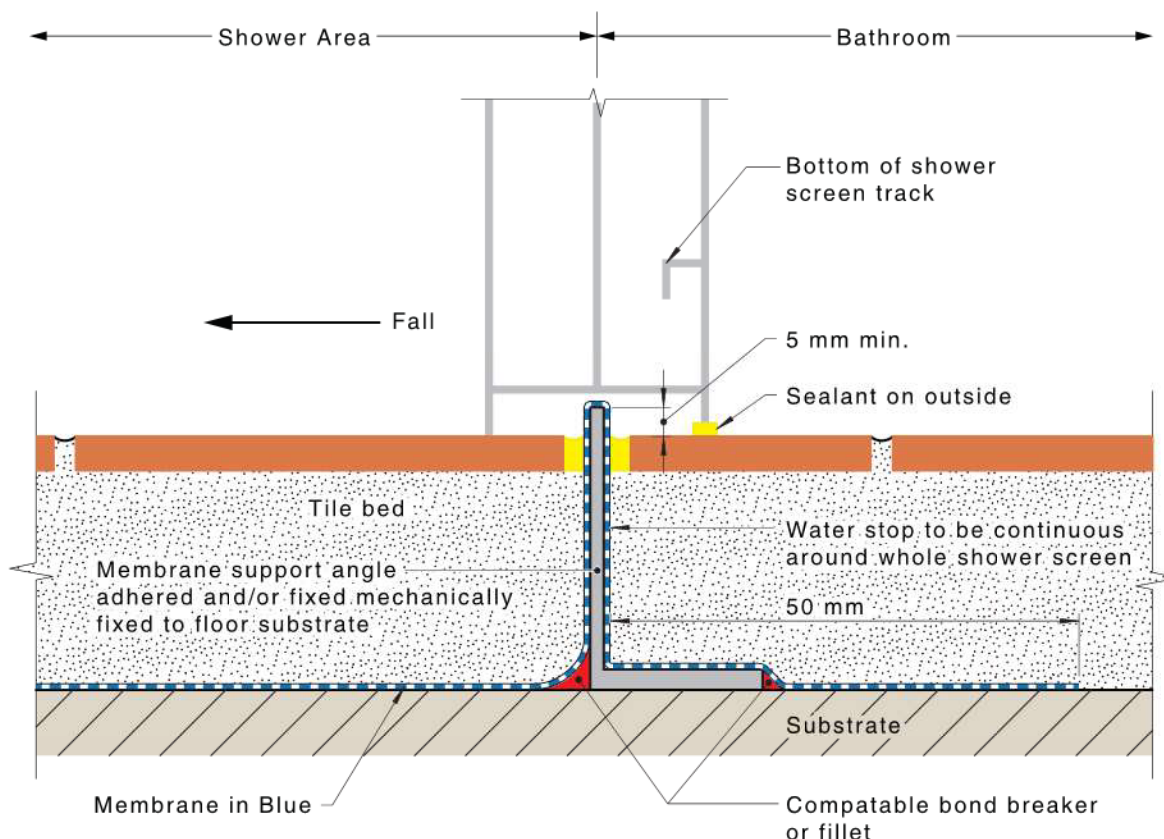
An enclosed shower shall incorporate a waterstop under the bottom rail of the shower screen and the opening. See [Figure 4.8.2\(B\)](#), [Figure 4.8.2\(C\)](#) and [Figure 4.8.2\(D\)](#).

#### 4.8.4 Waterstop for enclosed showers without hobs or set-downs

At the extremity of the shower area —

- (a) where a shower screen is to be installed, a waterstop shall be positioned so that its vertical leg will finish a minimum of 5 mm above the finished floor level (see [Figure 4.8.4](#)); and
- (b) where the waterstop intersects with a wall or is joined, the junction shall be waterproof.

NOTE For a typical hobless construction, see [Figure 4.8.4](#).



NOTE 1 Some shower screen extrusions do not permit the waterstop extending into a rebate. A channel section may be needed to be installed over the waterstop angle with the shower screen placed on top of the channel including return panels.

NOTE 2 The application of sealant is intended to prevent water from leaving the shower area. The application may be on the inside and/or outside face.

**Figure 4.8.4 — Typical hobless construction**

#### 4.8.5 Showers located near exits to wet areas

Where the extremity of a shower area is located within 200 mm of an exit from a wet area, it shall —

- (a) be an enclosed shower area as defined in [Clause 1.3.31](#).
- (b) have one of the following:
  - (i) A waterstop that finishes a minimum of 5 mm above the finished floor level, under the shower screen.
  - (ii) A hob at the extremity of the shower area.
  - (iii) A step-down of minimum 15 mm from the finished floor level at the extremity of the shower area.
- (c) have a vertical waterstop where the shower screen abuts the wall.

NOTE It is recommended that the floor surface outside the shower area should have fall away from the exit to prevent water escaping from the wet area.

## 4.9 Door openings

### 4.9.1 Perimeter flashing at floor level openings

The following requirements apply to perimeter flashing at floor level openings:

- (a) Whole wet area floor waterproofing shall incorporate —
  - (i) a waterstop that has a vertical leg finishing flush with the top of the finished floor level shall be installed at floor level openings; and
  - (ii) a floor membrane terminated to create a waterproof seal to the waterstop and to the perimeter flashing.
- (b) Waterproofing other than whole wet area floor waterproofing shall incorporate a waterstop that —
  - (i) has a vertical leg finishing flush with the top of the finished floor level installed at floor level openings; and
  - (ii) is integral with the perimeter flashing.
- (c) Perimeter flashing to wall, floor surfaces, and door openings shall —
  - (i) be continuously sealed to the horizontal surface;
  - (ii) have a vertical leg of a minimum of 25 mm above the finished floor level, except across doorways; and
  - (iii) have a horizontal leg with a minimum width of 50 mm.
- (d) Waterstops at cavity sliders shall —
  - (i) be returned across the cavity opening; and
  - (ii) have a membrane applied to form a continuous perimeter flashing.

NOTE For an example of waterproofing installation, see [Figure 4.9.1\(B\)](#).

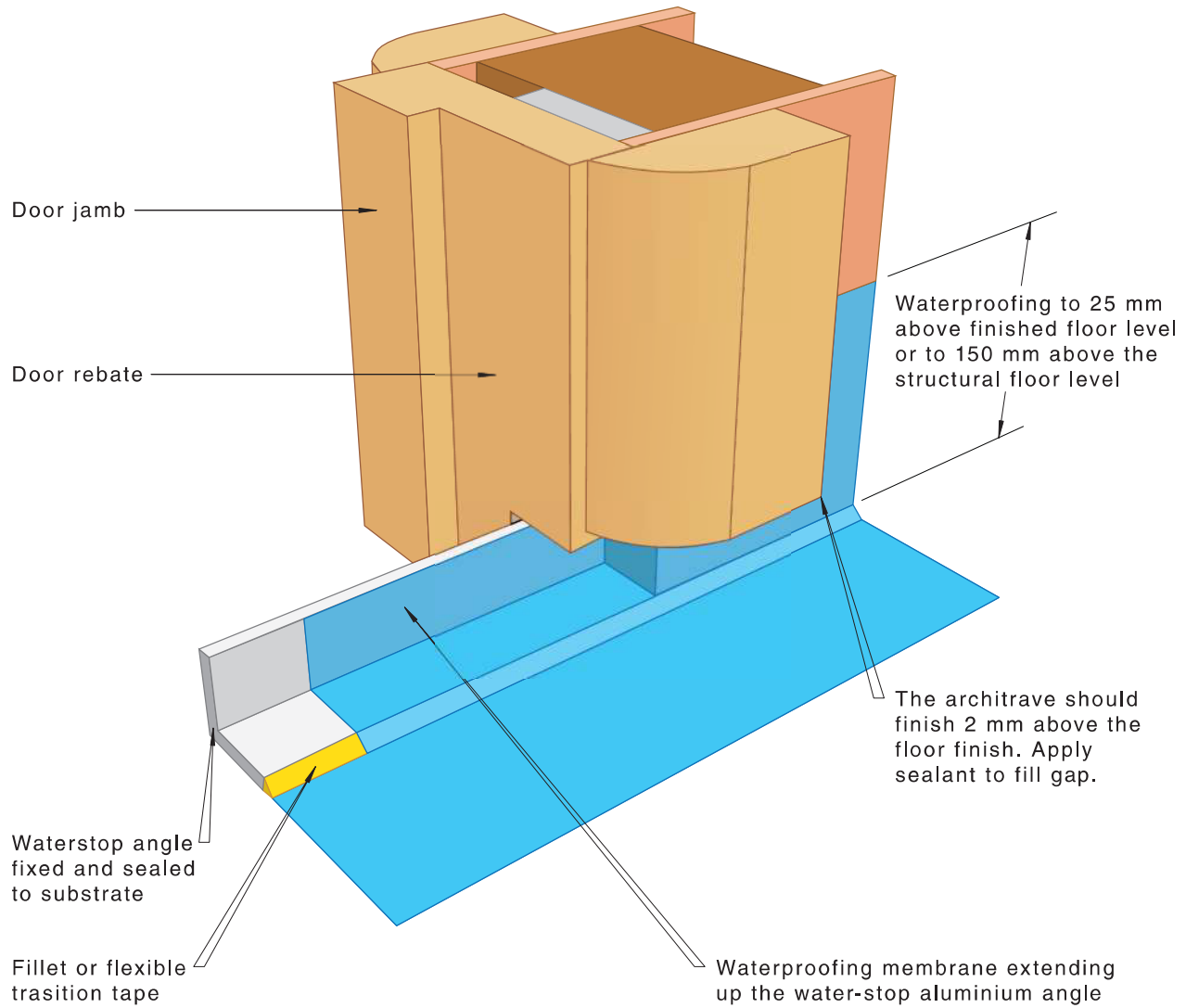
### 4.9.2 Protection of door frames and architraves

The requirements for protection of door frames and architraves are as follows:

- (a) Timber door frames shall not be embedded into the tiles.
- (b) There shall be a sealed gap of a minimum of 2 mm between the door architrave and the floor.
- (c) The underside of the door jamb and architrave shall be treated to resist moisture.

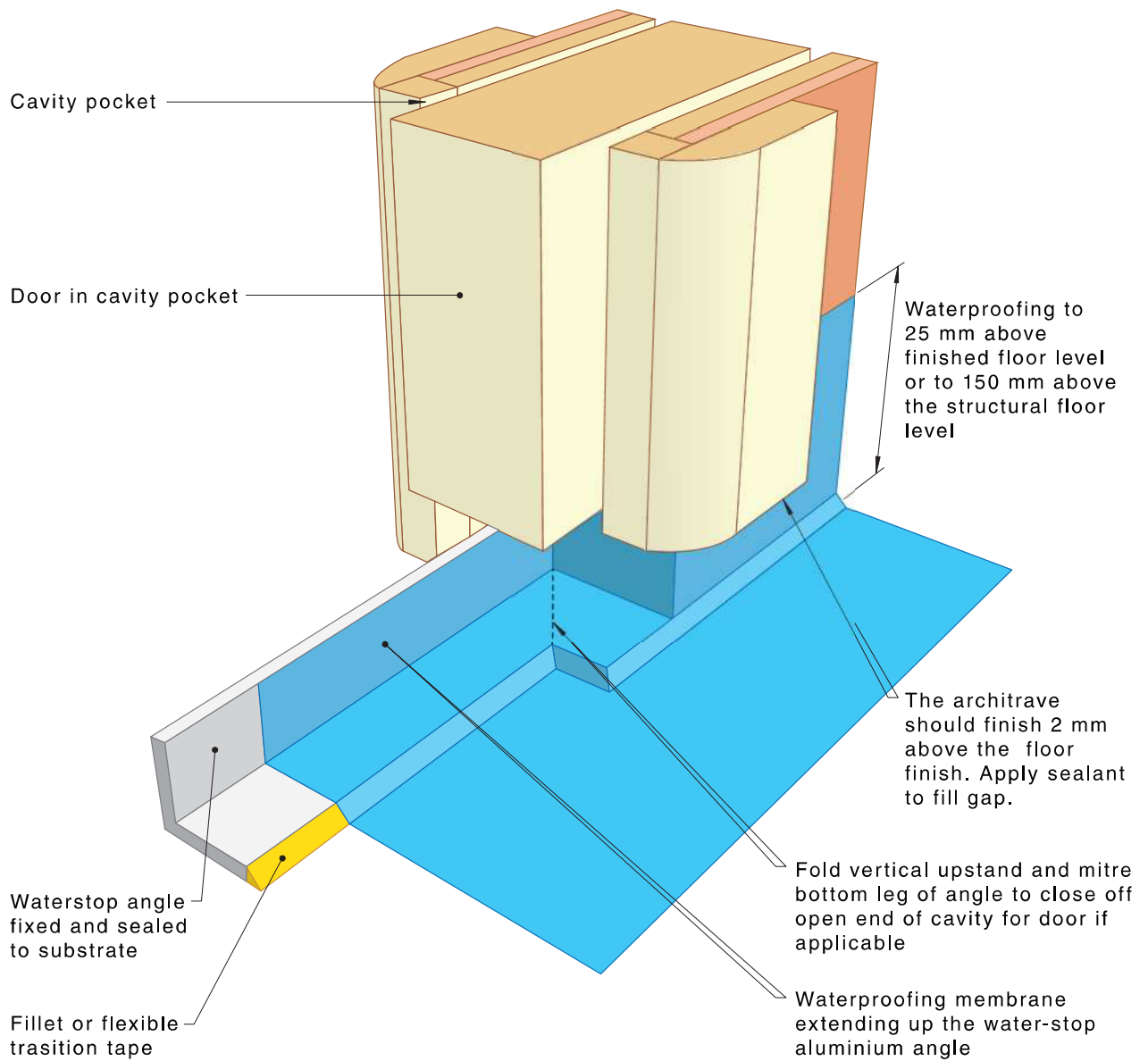
NOTE Some examples of moisture resistant treatments include paint, sealant, etc.

See examples of waterproofing installations in [Figure 4.9.1\(A\)](#), [Figure 4.9.1\(B\)](#), and [Figure 4.9.1\(C\)](#).

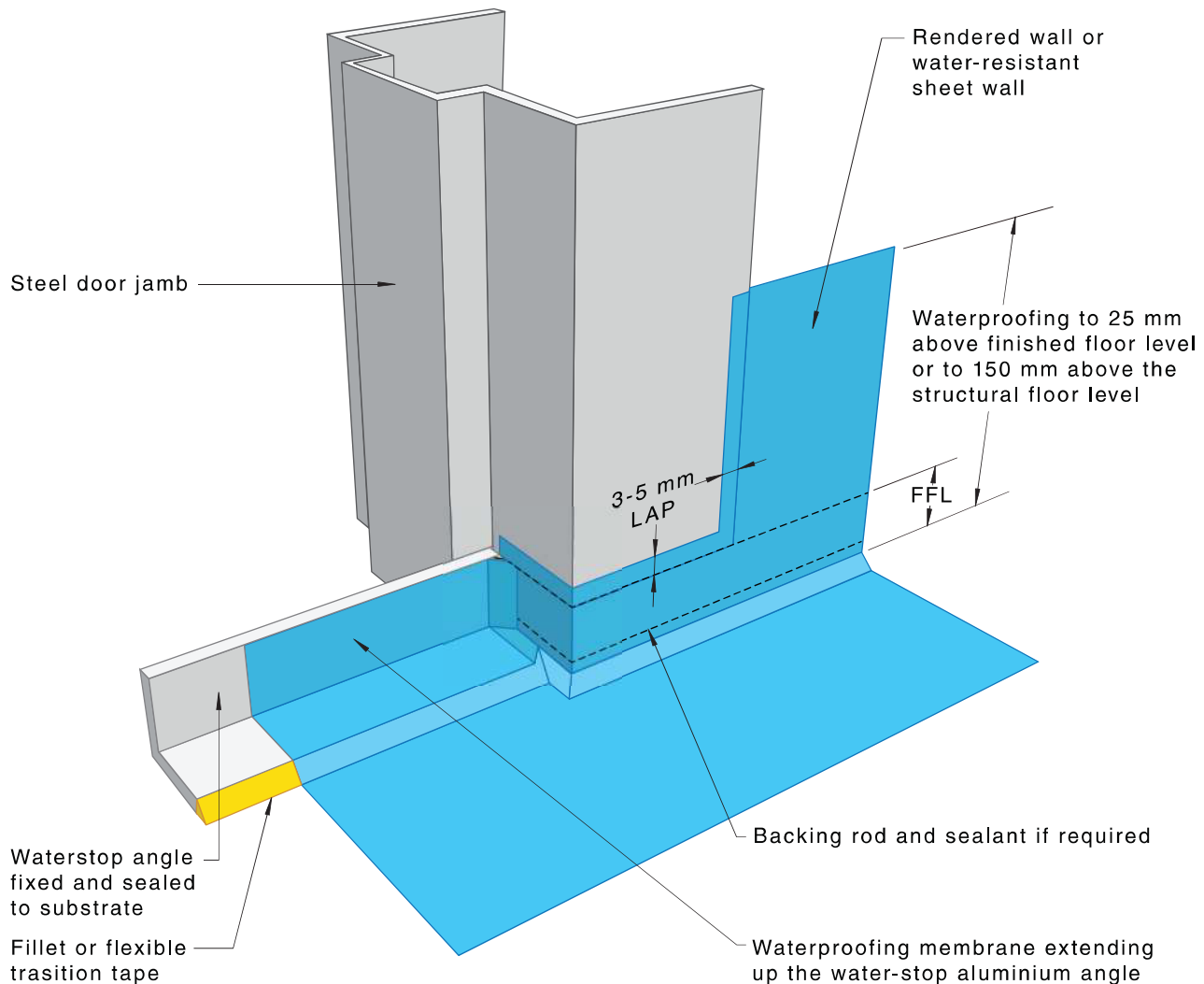


NOTE The waterstop angle may be located at the face of the door jamb or at the rebate.

**Figure 4.9.1(A) — Example of liquid waterproofing at door opening framework**



**Figure 4.9.1(B) — Waterproofing at door opening cavity slider**



**Figure 4.9.1(C) — Waterstop at door with steel frame**

**4.10 Fillets and bond breakers — bond breaker installation for bonded membranes**

At any change of plane or materials, and at movement joints, fillets or bond breakers shall be used where the membrane is bonded to the substrate. Bond breakers shall be of the type compatible with the flexibility class of the membrane to be used in accordance with [Table 4.10](#).

NOTE 1 Typical transition tape details are shown in [Figure 4.10](#).

NOTE 2 Additional information on bond breakers is given in [Appendix A](#).

NOTE 3 Fillets or bond breakers are not needed in the internal angle of waterstops.

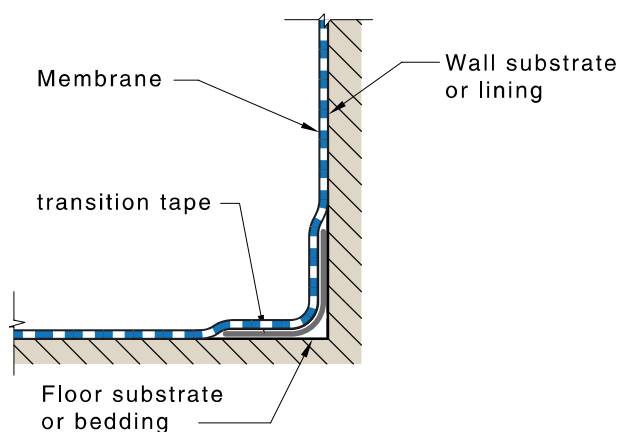
**Table 4.10 — Bond breakers**

Membrane class	Elongation at break	Minimum bond breaker/tape width
I	10 % to 59 %	100 mm
II	60 % to 299 %	35 mm
III	≥ 300 %	12 mm

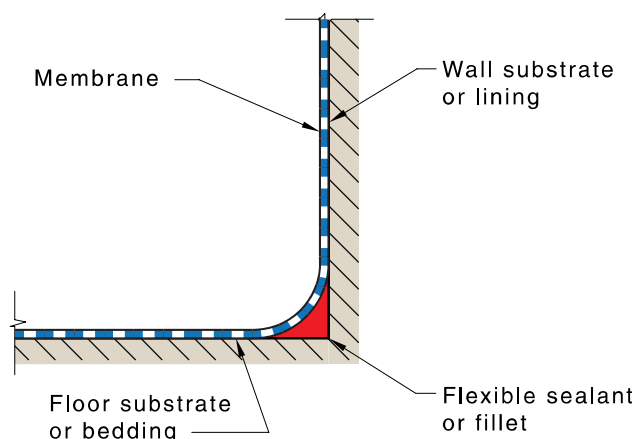
NOTE 1 Bond breakers for Class I membranes (low extensibility) allow the membrane to flex rather than stretch.

Table 4.10 (continued)

Membrane class	Elongation at break	Minimum bond breaker/tape width
NOTE 2 Bond breakers for Class II membranes (medium extensibility) allow the membrane to stretch. If a tape is used as a bond breaker, either the membrane will not bond to the tape or the tape will have elastic properties similar to the membrane.		
NOTE 3 Bond breakers for Class III membranes (high extensibility) allow the membrane to have even thickness.		



(a) Class I or II membrane



(b) Class III membrane

Figure 4.10 — Typical transition tape details

## 4.11 Junctions, transitions, and terminations

### 4.11.1 Types of junctions, transitions, and terminations

The following list specifies the minimum requirements for the treatment for various junctions. Junctions may be either wall to floor or wall to wall. Either the floor or wall may be waterproof, water resistant or have no treatment specified.

The types of junctions that shall be used are as follows:

- (a) *Type 1* — Where waterproof to waterproof surfaces meet, the waterproofing shall be continuous across the junctions and shall be deemed to be a waterproof junction.
- (b) *Type 2* — Where waterproof to water-resistant surfaces meet, a bead of sealant shall be deemed to be a waterproof junction.
- (c) *Type 3* — Where water-resistant to water-resistant surfaces meet, a bead of sealant shall be deemed to be a water-resistant junction.
- (d) *Type 4* — Where non-water-resistant or non-waterproof surfaces meet water-resistant surfaces, a bead of sealant shall be deemed to be a water-resistant junction.

NOTE Membrane connections to barrier stops in conjunction with a junction sealant ensures a transition that maintains even, required dry film thickness (DFT).

#### 4.11.2 Vertical flashing for shower wall junctions

Vertical flashing may be external or internal and shall terminate a minimum of 1 800 mm above the finished floor level of the shower or base of the bath or tray, or 50 mm above the shower rose, whichever is the higher.

Vertical flashing shall be used as follows:

- (a) External vertical flashing may be used with external membranes systems and installed behind the wall sheeting or render, provided they have legs of sufficient width to allow the wall sheeting or render to overlap by a minimum of 30 mm. The mechanical fastening of the wall sheeting shall not penetrate the flashing.
- (b) Internal vertical flashing may be used with both external and internal membrane systems, provided each leg has a minimum overlap of 40 mm to the wall sheeting or render and, where used with —
  - (i) internal membranes, each leg extends vertically from within the shower tray;
  - (ii) external membranes, each leg overlaps the top edge of the floor waterproofing system, by a minimum of 20 mm; and
  - (iii) preformed shower bases or baths, each leg extends to the bottom edge of the wall sheeting or render.

NOTE 1 The membrane should be terminated to a Type 2 junction sealant as per [Clause 4.11.1](#).

NOTE 2 Where a shower rose is ceiling mounted, the membrane should terminate to the full height of the wall to a Type 3 junction sealant as per [Clause 4.11.1](#).

## 4.12 Penetrations

### 4.12.1 Shower areas

Penetrations for fixtures such as taps, shower nozzles, recessed soap holders and the like, shall be waterproofed by sealing with pre-formed flange systems or a sealant. When sealing the tap body to the wall, allowance shall be made for the servicing of tap washers or ceramic disks without damaging the waterproofing or seal.

NOTE 1 Typical niche detail for shower areas is shown in [Figure 4.12.4](#).

NOTE 2 Where shower roses are ceiling mounted, the penetration should be sealed and sheet fixings should be set with water resistant setting compounds.

NOTE 3 For mixer taps, drainage may be allowed at the base of the cover plate.

NOTE 4 Mixer taps that cannot be incorporated into a waterproofing membrane system and maintain the integrity of that waterproofing system are not addressed in this document.

Any penetrations of mechanical fixings or fastenings through surface materials shall be waterproofed.

#### 4.12.2 Horizontal surface taps

Tap penetrations on horizontal surfaces surrounding baths and spas shall be waterproofed by sealing —

- (a) with pre-formed flange systems;
- (b) the tap body to the membrane; or
- (c) the substrate where a membrane is not required.

Connection and sealing to tap bodies shall be treated as a Type 2 termination as per [Clause 4.11.1](#)

#### 4.12.3 Other penetrations in Category 1 areas

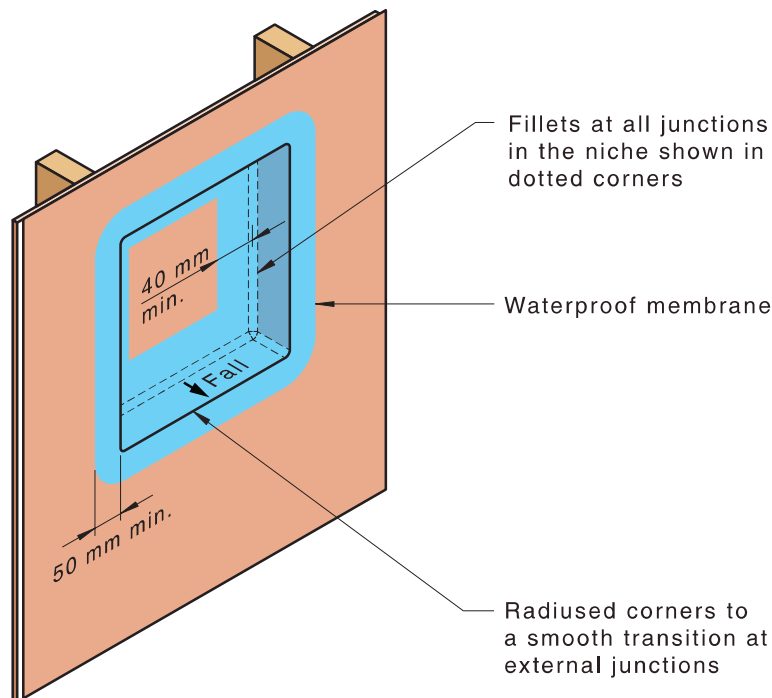
Penetrations through water-resistant substrates and surface finishes shall be sealed in accordance with [Clause 4.11.1](#).

Where fixings penetrate surfaces required to be waterproof, the flexible sealant shall be compatible with the waterproof membrane material.

#### 4.12.4 Niches, inlaid soap holders, and footrests

The requirements for niches installed in the wall of a shower area are as follows:

- (a) Niches shall be lined on all surfaces with a water-resistant substrate material in accordance with [Clause 3.3.2](#).
- (b) Internal linings of niches shall be separated from any wall linings on the opposite side of the wall.
- (c) Waterproofing shall be applied to all surfaces and fillets or bond breakers shall be applied according to the membrane being used in accordance with [Clause 4.10](#).
- (d) The base of a niche shall have a minimum grade fall of 1:100 towards the shower.



NOTE Bond breaker or fillet to suit the membrane at all internal junctions in the niche shown in yellow.

**Figure 4.12.4 — Niche in shower wall framework**

## 4.13 Baths and spas

### 4.13.1 General

Baths and spas shall be supported to prevent distortion and cracking. Baths and spas that are recessed into the wall shall be installed to allow the water-resistant surface materials of the wall to pass down inside the rim of the bath or spa. The wall substrate shall be connected to the bath with a Type 2 junction sealant, as per [Clause 4.11.1](#), compatible with the membrane.

Where a bath end wall is within a shower area, it shall be treated as a shower area wall.

NOTE 1 For typical bath/spa wall junctions, see [Figure 4.13.3\(A\)](#) to [Figure 4.13.3\(E\)](#).

When installing baths and spas, the integrity of the structure shall be maintained.

For insert baths, a waterstop shall be installed around the periphery.

NOTE 2 Where a Type 1 or 2 unenclosed shower is adjacent to a bath, it should be treated as a shower over bath.

### 4.13.2 Baths without showers over them

#### 4.13.2.1 Baths without an integral upstand edge — insert baths

There shall be full waterproofing of walls around the bath to 150 mm above any shower rose connection.

#### 4.13.2.2 Baths to be recessed into a wall with no shower over them

Baths recessed into a wall shall have an integral vertical upstand lip along the side of the bath walls to enable a waterproof junction between the bath and walls. There shall be full waterproofing of bath/wall junctions. The walls around the bath shall be water resistant to 150 mm above the bath edge.

Figures 4.13.2.2(A) to 4.13.2.2(E) show examples of baths recessed in to various wall types.

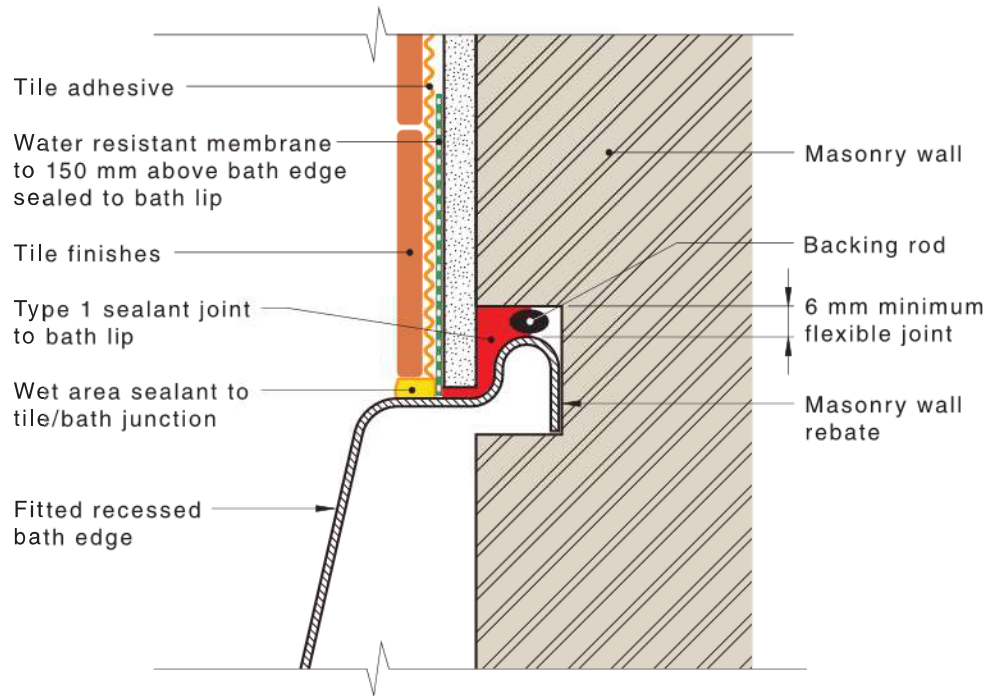


Figure 4.13.2.2(A) — Bath with no shower over it — Fitted bath — Masonry wall

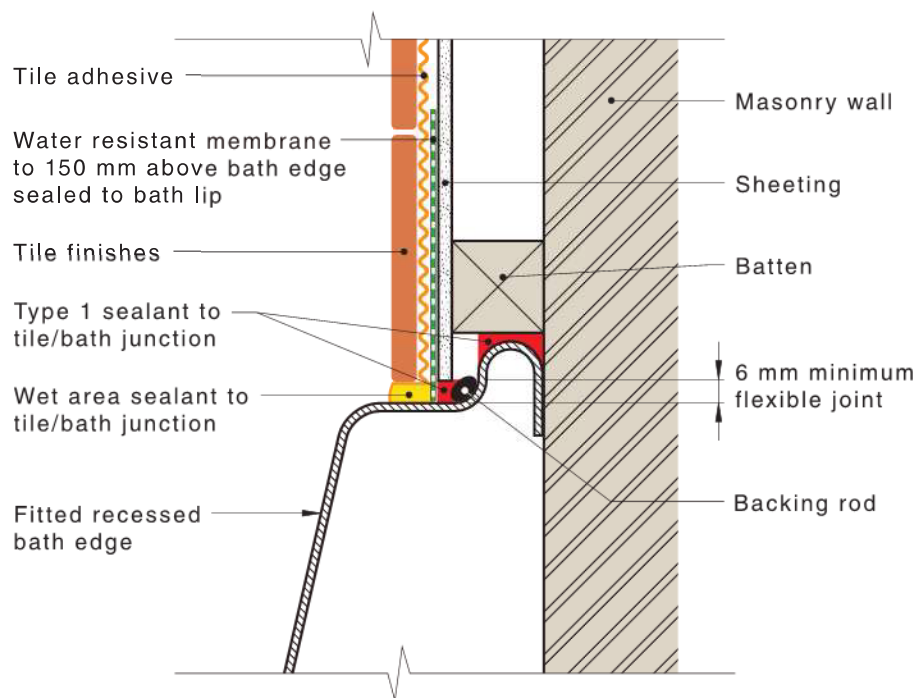
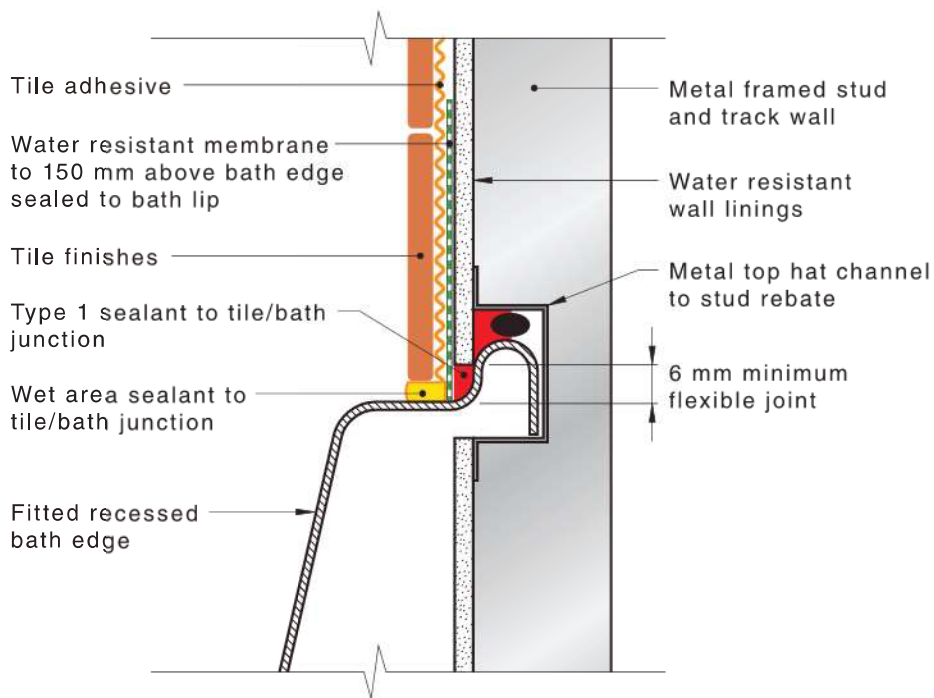
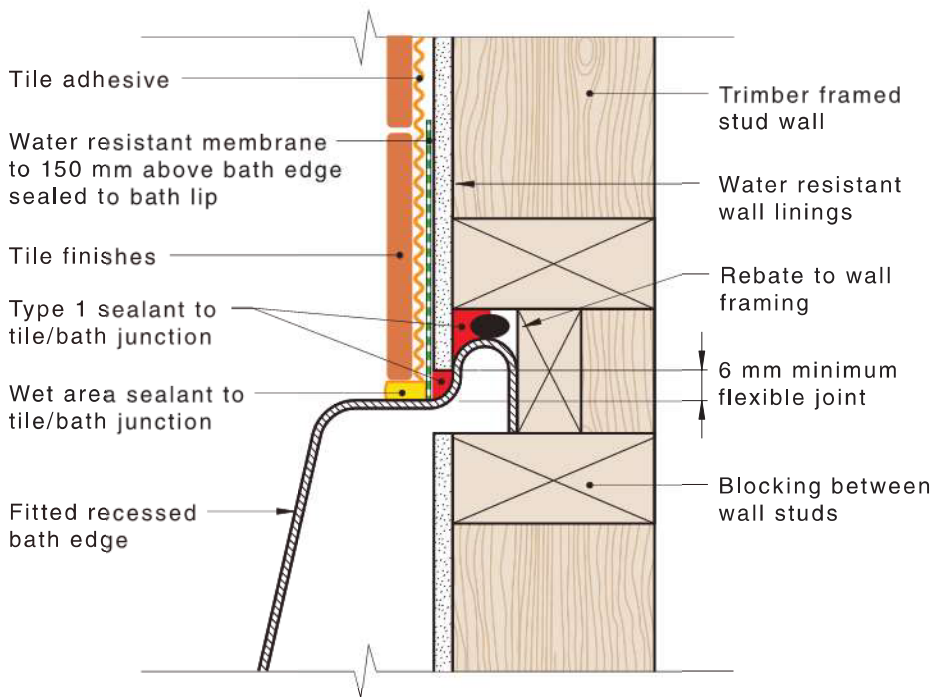


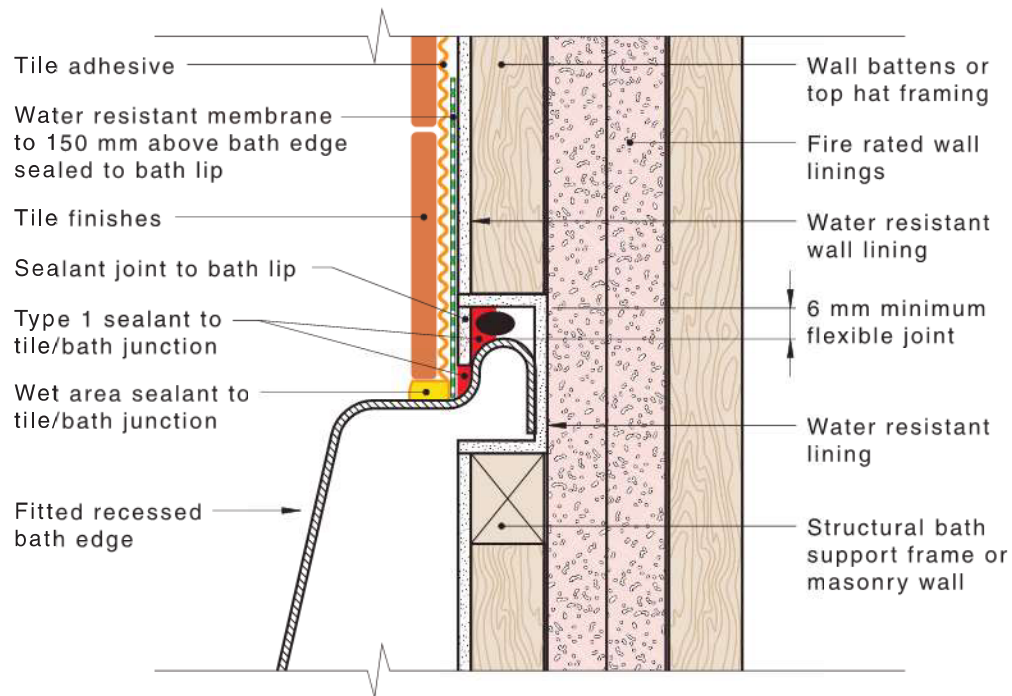
Figure 4.13.2.2(B) — Bath with no shower over it — Fitted bath — Masonry wall with sheet spaced via battens



**Figure 4.13.2.2(C) — Bath with no shower over it — Fitted bath — Metal framed wall**



**Figure 4.13.2.2(D) — Bath with no shower over it — Fitted bath — Timber-framed wall**



**Figure 4.13.2.2(E) — Bath with no shower over it — Fitted bath — Fire rated framed wall**

### 4.13.3 Baths with showers over them

#### 4.13.3.1 Bath adjoining a Type 2 unenclosed shower

A bath installation adjoining a Type 2 unenclosed shower shall be waterproofed as a shower-over-bath installation for fitted or insert baths according to [Clauses 4.13.3.2](#) and [4.13.3.3](#).

#### 4.13.3.2 Baths recessed into a wall — fitted baths

There shall be full waterproofing of walls around the bath to 150 mm above the edge of the bath. There shall be full waterproofing to junctions and penetrations at a minimum of 1800 mm from the bath floor.

#### 4.13.3.3 Baths without an integral upstand edge — insert baths

There shall be full waterproofing of walls around the bath to 150 mm above the edge of the bath. There shall be full waterproofing to junctions and penetrations at a minimum of 1800 mm from the bath floor.

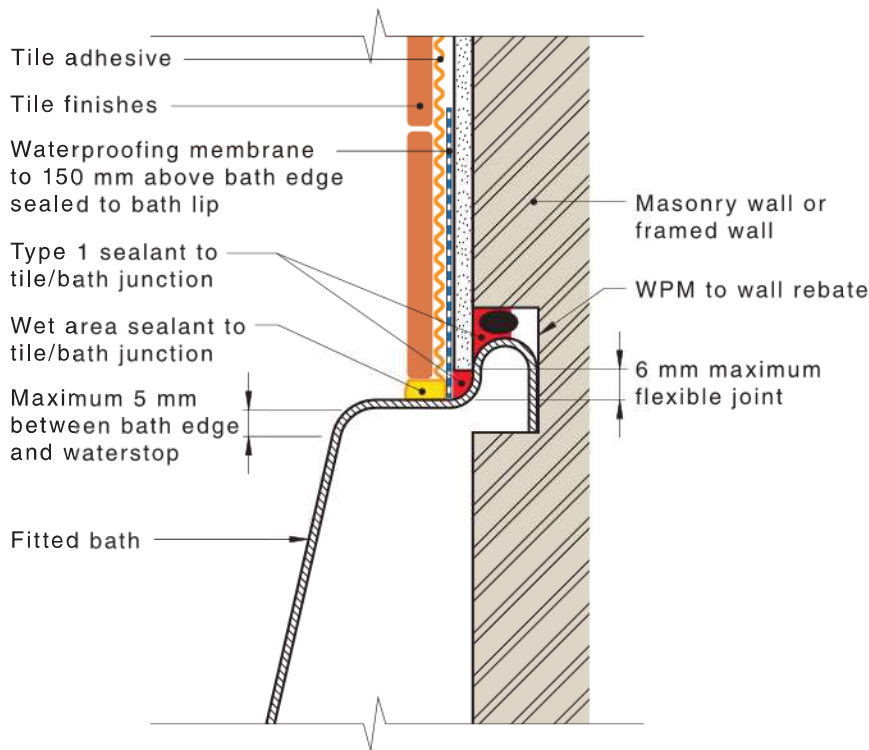


Figure 4.13.3(A) — Shower over bath — Fitted bath — Framed or masonry walls

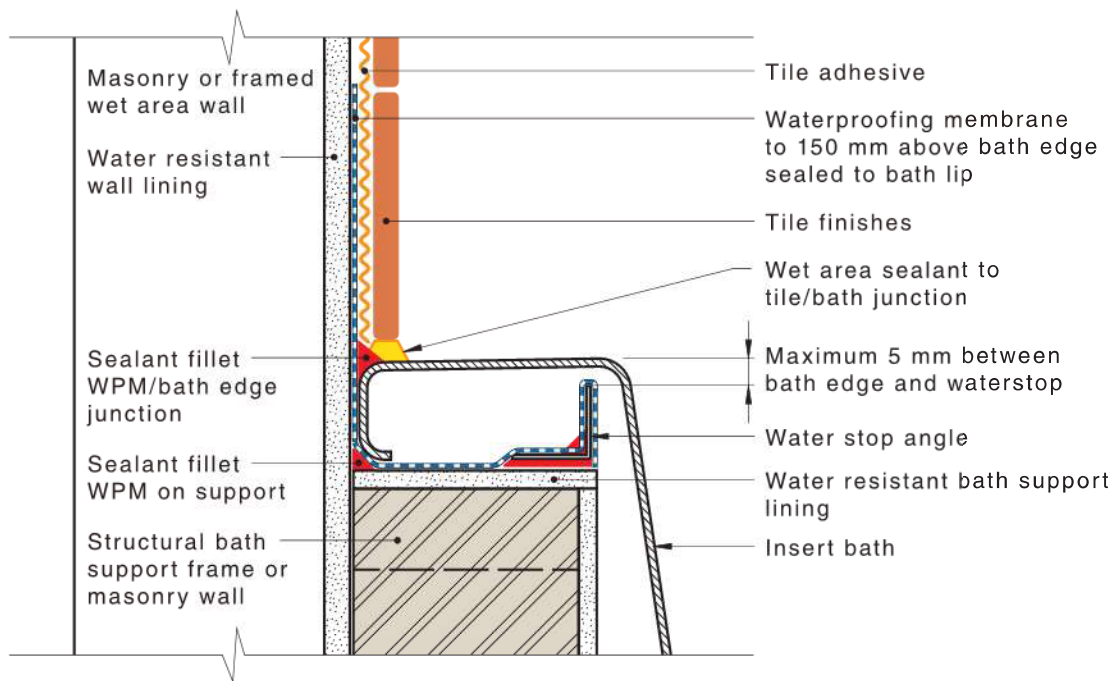
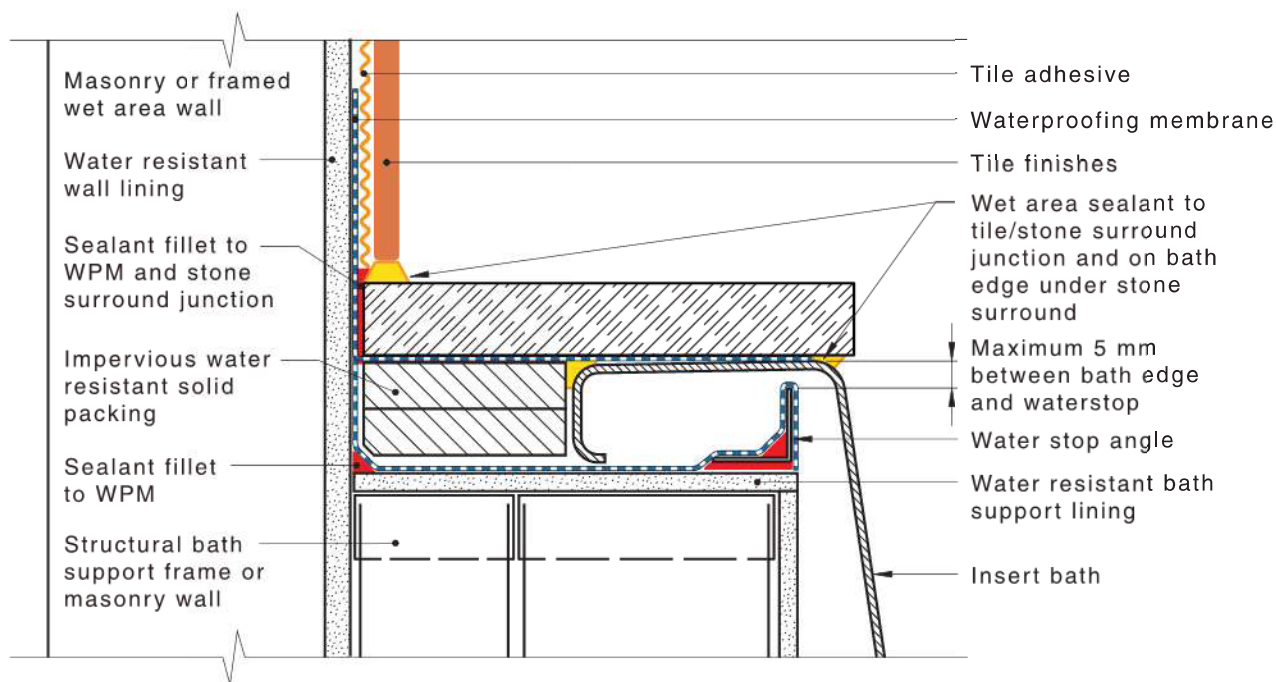
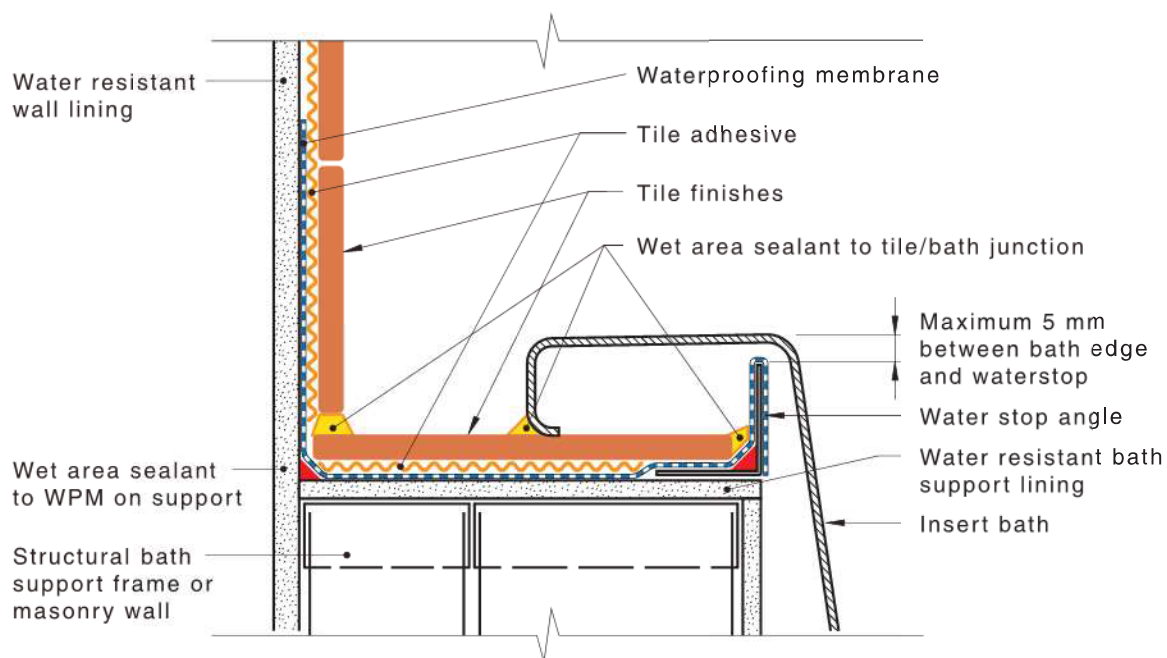


Figure 4.13.3(B) — Shower over bath — Fitted bath — Fitted against wall

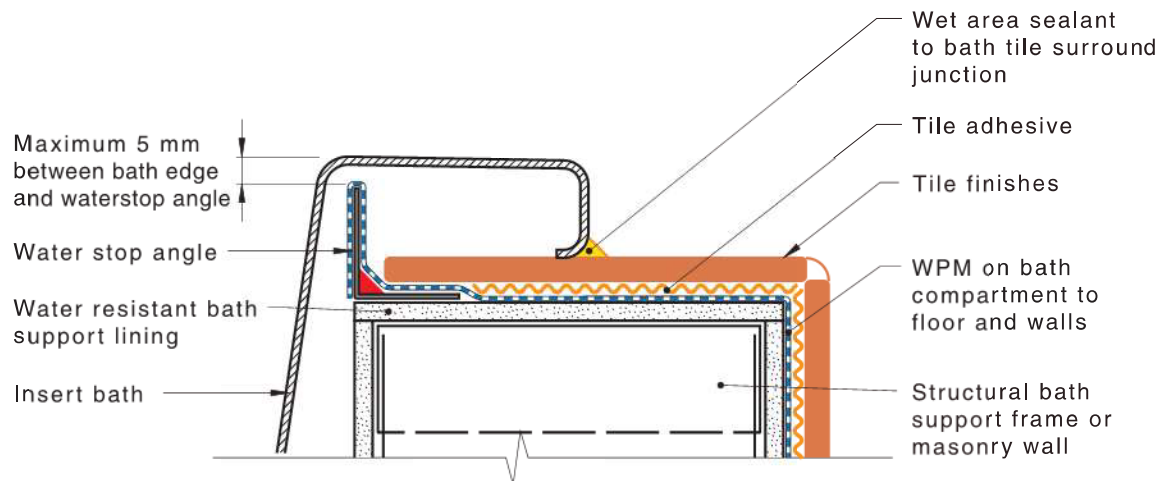


**Figure 4.13.3(C) — Shower over bath — Insert bath — Stone surround**



**Figure 4.13.3(D) — Insert bath — Tile surround**

Copyrighted material licensed to TasTAFE by Techstreet LLC. Subscription to techstreet.com downloaded on 2023-05-30 00:12:40 +0000 by TasTAFE User. No further reproduction or distribution is permitted.



**Figure 4.13.3(E) — Shower over bath — Insert bath — Bath compartment wall**

#### 4.13.4 Freestanding baths

The extent of waterproofing for freestanding baths with or without a shower over them shall be as for Type 2 unenclosed shower (see [Clause 4.8.2](#) and [Figure 4.8.2\(A\)](#)).

#### 4.13.5 Bath end walls abutting a shower

Where a bath end wall is within a shower area, it shall be treated as a shower area wall.

NOTE Where a Type 1 or 2 unenclosed shower is adjacent to a bath, it should be treated as a shower over bath.

#### 4.13.6 Spa baths

When installing spa baths, the following shall apply:

- (a) Waterproofing underneath spa to 150 mm vertical termination to internal spa shell.
- (b) Provision of overflow to outer floor to conforming leak control flange to a maximum of 30 mm below waterproofing tanking to spa shell.  
NOTE 1 Where drainage is provided under the spa, it should be at membrane level with falls to waste.
- (c) Where non-proprietary access to the pump is provided, water is to be excluded from entering the access panel.
- (d) Pump mountings to be sealed so as not to perforate the membrane.
- (e) Provision of ventilation under spa shell to manage condensation.
- (f) Where drainage is provided under the spa, provision of that drainage at membrane level with falls to waste.

NOTE 2 See [Figure 4.13.6](#) for spa bath compartment detail at bath face.

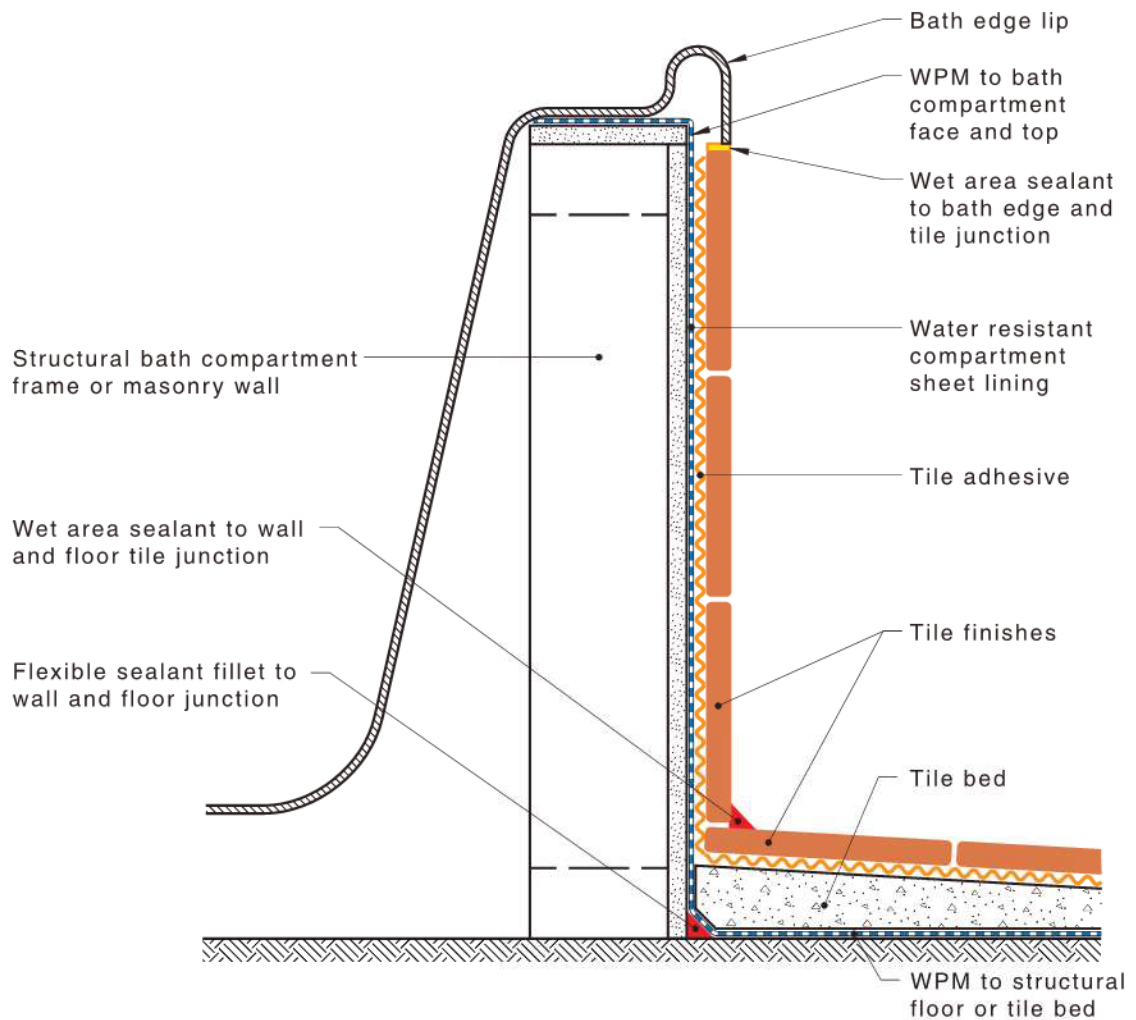


Figure 4.13.6 — Spa and bath compartment detail at bath face

#### 4.14 Preformed shower bases

Preformed shower bases shall be —

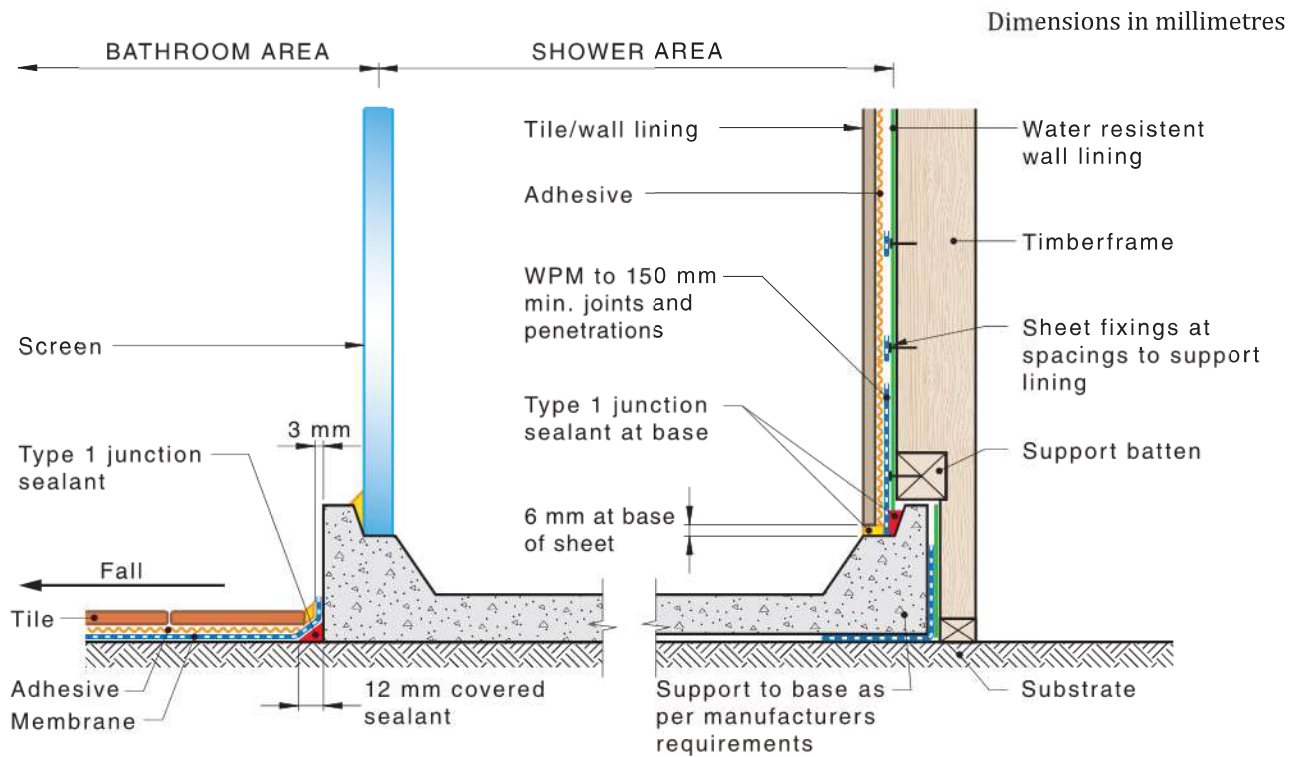
- (a) supported to prevent distortion or cracking; and
- (b) recessed into the wall to allow the water-resistant surface materials to pass down inside the perimeter rebate over the upstands of the shower base.

Pre-formed trays, baths, receptacles shall be supported at the base.

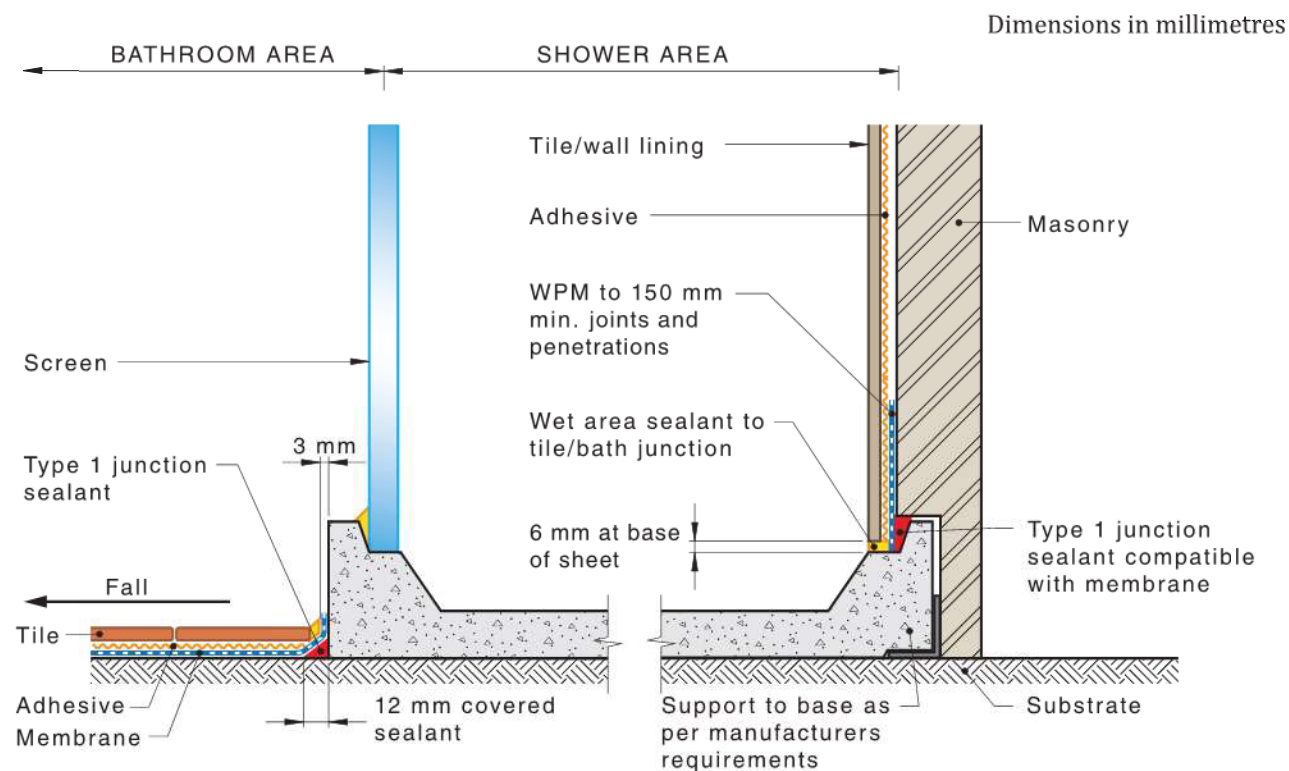
NOTE 1 For guidance on installation, refer to the manufacturer.

NOTE 2 For guidance on installation of the waste pipe connection, refer to AS 3500.

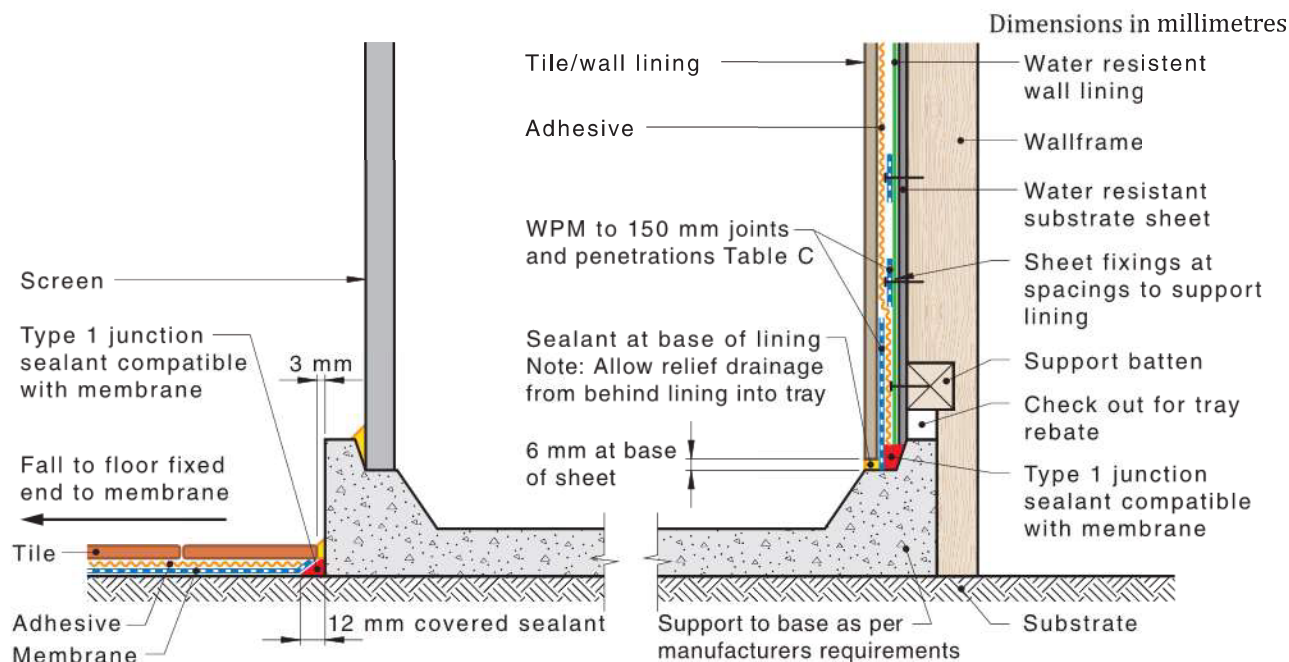
NOTE 3 For typical base junction, see [Figure 4.14\(A\)](#), [Figure 4.14\(B\)](#), and [Figure 4.14\(C\)](#).



**Figure 4.14(A) — Section through stud wall with self-supporting prefinished wall panels and preformed or cast shower bases**



**Figure 4.14(B) — Section through rendered masonry wall and preformed or cast shower base**



**Figure 4.14(C) — Preformed shower base checked into wall, frame or render**

## 4.15 Enclosed shower screen placement

### 4.15.1 Showers with hobs

The shower screen shall be installed so as to ensure it is —

- (a) flush with the shower area side of the hob; or
- (b) overhanging into the shower area; or
- (c) inside the hob.

NOTE A self-draining sub-sill is considered to be part of the shower screen.

### 4.15.2 Showers with step-downs

The shower screen shall be installed so as to ensure it is —

- (a) flush with the finished vertical surface of the step-down; or
- (b) overhanging into the shower area; or
- (c) inside the step-down of the shower area.

### 4.15.3 Showers without hobs or step-downs

The shower screen shall be positioned —

- (a) over the top of the waterstop that defines the shower area; or
- (b) inside the waterstop that defines the shower area.

Where the shower screen is positioned over the top of the waterstop, the shower screen shall incorporate or be mounted on an inverted channel.

NOTE For a typical hobless construction, see [Figure 4.8.4](#).

#### 4.15.4 Bath end walls and nib walls abutting a shower

The shower screen shall be positioned so that the bottom edge within the shower area is either flush with the outside edge of the bath or overhanging into the shower area.

NOTE A self-draining sub-sill is part of the shower screen.

#### 4.16 Vinyl

Finished PVC floor and wall coverings shall be installed in accordance with AS 1884.

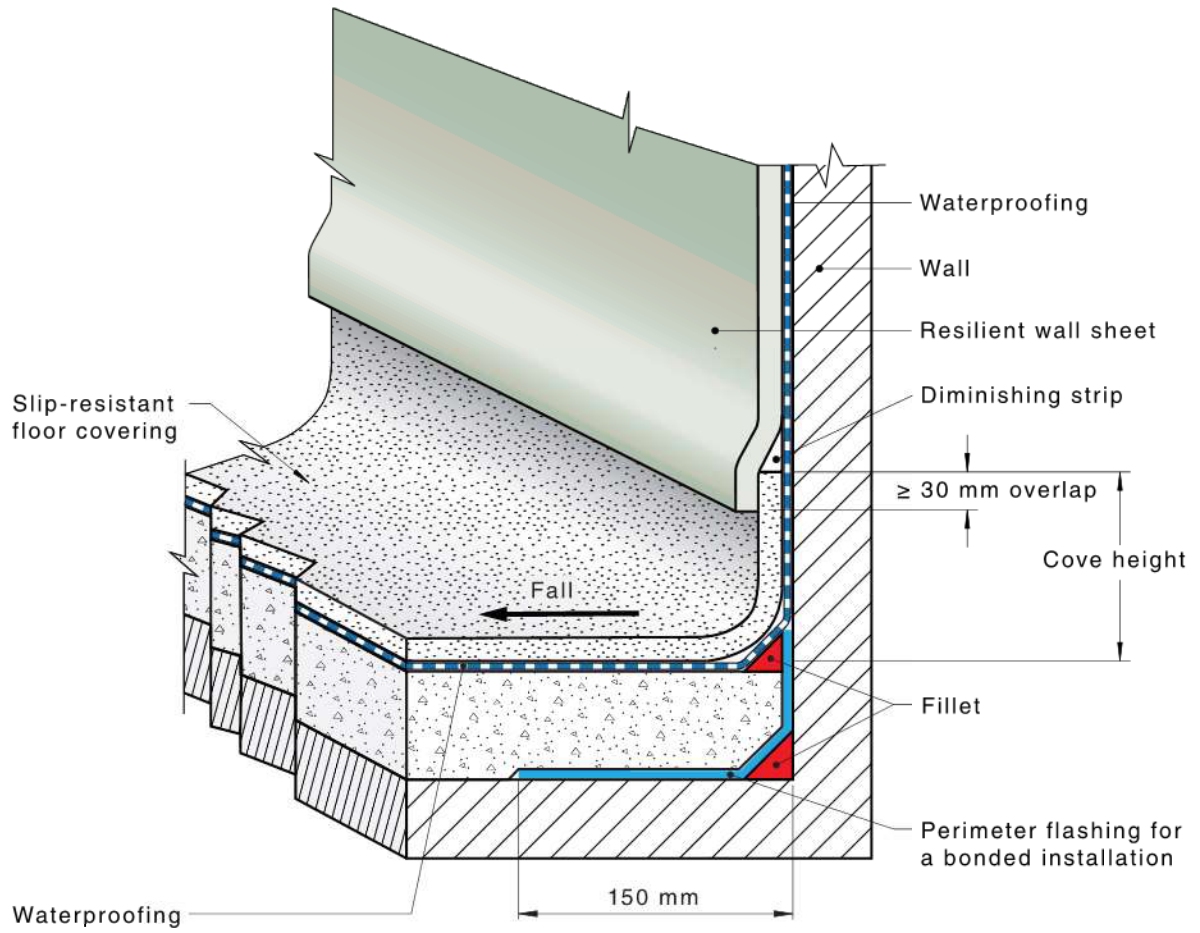
Where thermally welded water-resistant vinyl sheet floor covering is used, the sheet shall be secured to the drain with a mechanical clamp system that will fix and seal the sheet at the point of termination.

The waterproofing to waste connection shall be in accordance with [Clause 4.3](#).

NOTE 1 Examples of vinyl installations are shown in [Figure 4.16\(A\)](#), [Figure 4.16\(B\)](#), and [Figure 4.16\(C\)](#).

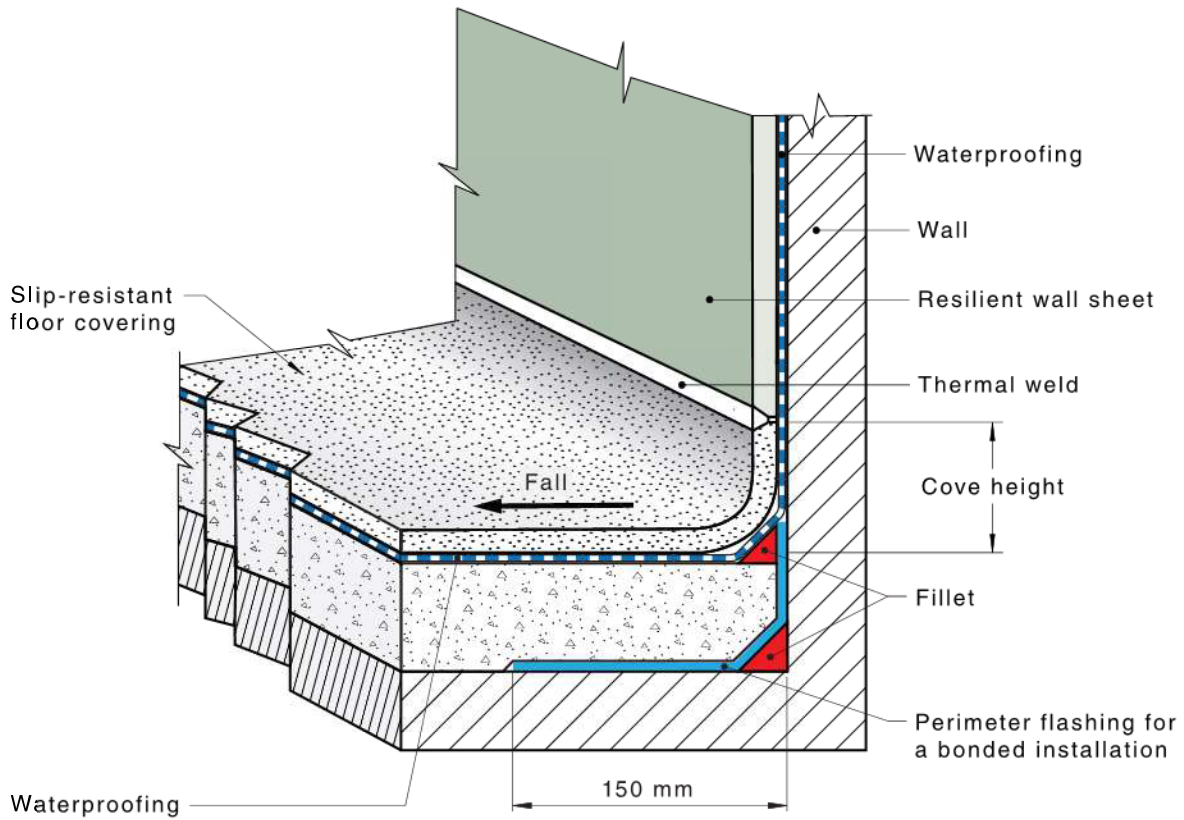
Welded resilient floor coverings that do not meet AS/NZS 4858 are classified as water resistant not waterproof. A waterproof membrane in accordance with AS/NZS 4858 shall be installed in wet areas where there is a floor waste or in other areas where waterproofing is required as identified in this document and cross referenced with the National Construction Code (NCC).

NOTE 2 Where a screed is installed against a porous substrate, a perimeter flashing should be provided that is compatible.



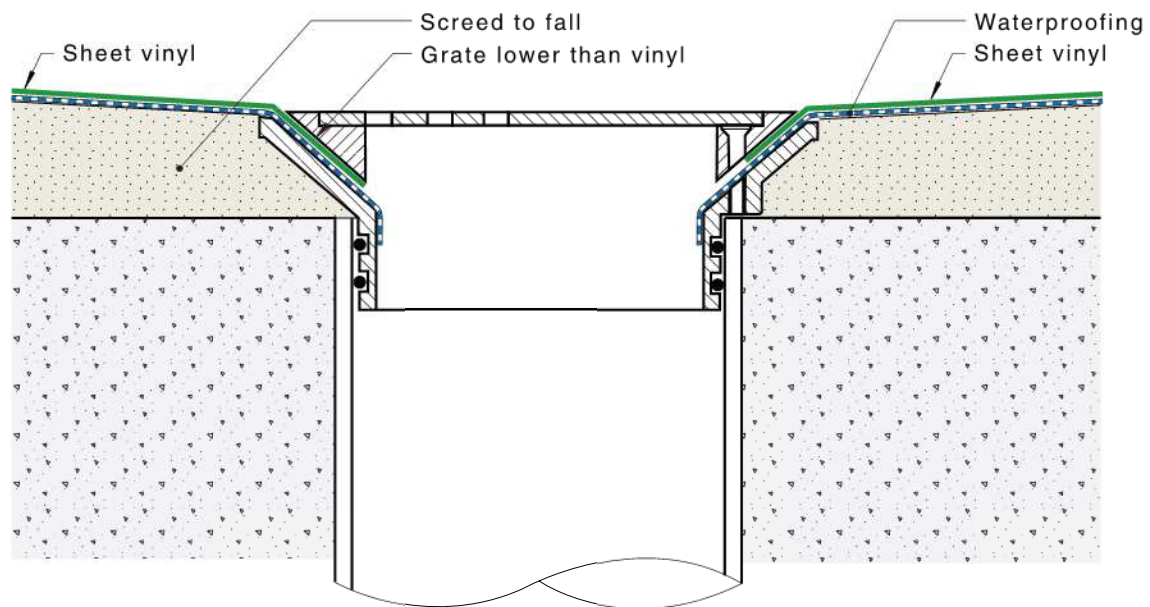
**Figure 4.16(A) — Vinyl installation — Overlap method**

[SOURCE: AS 1884:2021 Figure 5.1 amended to include waterproofing.]



**Figure 4.16(B) — Vinyl installation — Welded method**

[SOURCE: AS 1884:2021 Figure 5.2 amended to include waterproofing.]



**Figure 4.16(C) — Vinyl installation — Push-in vinyl sheet waste**

[SOURCE: AS 1884:2021 Figure 5.5 amended to include waterproofing.]

#### 4.17 Polished concrete

Waterproofing systems beneath polished concrete shall be installed in accordance with [Clause 4.6](#), [Clause 4.7](#), [Clause 4.8](#), [Clause 4.9](#), [Clause 4.10](#), [Clause 4.11](#) and their sub-clauses, and the following requirements:

- (a) Membrane shall be protected from abrasive damage when placing and vibrating the topping concrete by installing a protective underlayment.
- (b) Membrane detail to vertical surfaces and walls are to be protected against damage caused when placing and polishing the concrete and incompatible sealers.
- (c) Topping concrete shall be bonded to the protective underlayment with a compatible bond coat.

NOTE [Figure 4.17](#) shows a typical polished concrete floor installation.

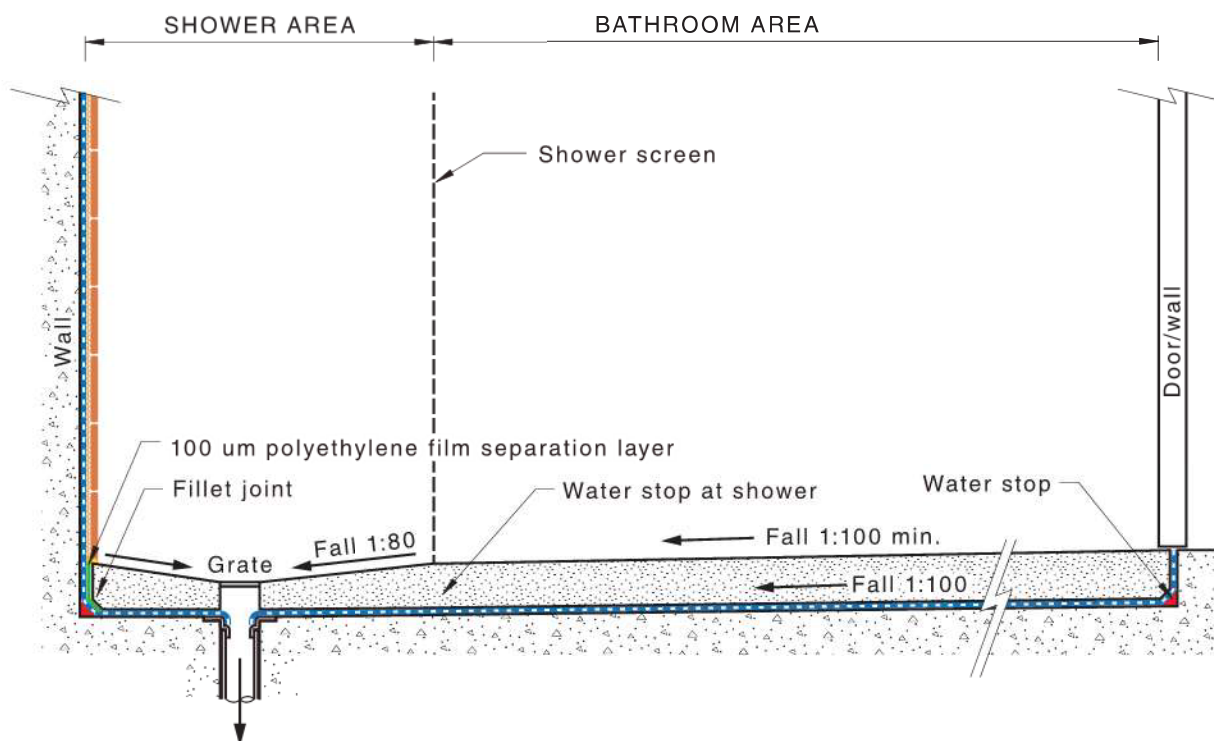


Figure 4.17 — Polished concrete floor for unenclosed shower

#### 4.18 Floor heating

Underfloor heating cables shall not penetrate waterproofing membranes.

Underfloor heating cables shall not penetrate waterstop angles.

## Appendix A (informative)

### Design considerations in wet-area waterproofing

#### A.1 Scope

This appendix provides information that should be considered when designing waterproofing systems for wet areas in domestic buildings and includes guidelines for dealing with the degree of risk, and the types of materials used and their locations in the construction.

#### A.2 General

Every waterproofing system in an internal wet area should be:

- (a) Correctly designed and installed.
- (b) Compatible with other building materials that they will be in contact with.
- (c) Sufficiently flexible to accommodate normal movement in building structures.
- (d) Resistant to constant saturation by water and household chemicals such as those in cleaning agents.

#### A.3 Category of risk for wet areas

##### A.3.1 General

Domestic wet areas should be classed into one of three categories according to the risk of water or moisture causing unhealthy and hazardous conditions or damage to the building structure.

##### A.3.2 Category 1 wet areas (high risk)

Category 1 wet areas include —

- (a) enclosed shower areas;
- (b) unenclosed shower areas;
- (c) baths with unenclosed showers over them;
- (d) any area within the reach of a hand-held shower fitting;
- (e) water closets with a hand-held douche spray; and
- (f) dedicated douche rooms.

##### A.3.3 Category 2 wet areas (moderate risk)

Category 2 wet areas include —

- (a) the whole of the bathroom area outside an unenclosed shower area; and
- (b) the whole of the bathroom area outside an unenclosed shower over bath.

### **A.3.4 Category 3 wet areas (low risk)**

Category 3 wet areas include any wet area without a shower, such as —

- (a) bathroom areas outside enclosed shower areas;
- (b) bathrooms without a shower area;
- (c) water closets or powder rooms; and
- (d) laundry rooms without a shower.

## **A.4 Leakage through finishes**

Water may penetrate wall and floor finishes in wet areas, depending on the frequency, the intensity and the length of time these surfaces are exposed to water; if not intercepted, water may damage the moisture-sensitive materials lying beneath, and sometimes reach adjoining rooms and their finishes. Consequently, careful attention should be paid to the design and installation of all materials, components and systems to prevent damage by water.

Water penetration mainly occurs at joints. Grouted joints will often shrink, producing cracks that allow water to pass through. At floor and wall junctions, these cracks can be caused or enlarged by movement of the structure, substrate or finishes.

## **A.5 Movement and waterproofing**

### **A.5.1 General**

Movement in the wall and floor structure is often caused by contraction, expansion or settlement. Users of this document should be aware of the need for waterproofing materials or systems to accommodate the expected movement of the structure.

### **A.5.2 Structure movement**

#### **A.5.2.1 Frame movement**

Potential movement of corner studs is restricted if the studs are fastened to intermediate blocking pieces. Where the framing is constructed of metal or seasoned timber, blocking is generally a provision to restrict structural deflection.

Unseasoned timber shall be examined for movement and its subsequent effects upon the waterproofing system.

#### **A.5.2.2 Masonry movement**

Masonry products such as clay-based materials, cement-based materials and autoclaved aerated materials may be subject to specific movement characteristics depending on the material used. These products also require consideration of movement and its subsequent effects upon the waterproofing system.

#### **A.5.2.3 Panel movement**

Panel products are also subject to movement, particularly at joints. Such products also require consideration of movement and its subsequent effects upon the waterproofing system.

### A.5.3 Wall linings under tiles in shower areas

Nominated linings in Category 1 wet areas that have been waterproofed will provide protection to the structure behind and prevent damage from water that may otherwise penetrate the wall linings. The joints between lining sheets and their junctions with other materials may require special attention to maintain the waterproofing system durability as they will provide a direct path for water and consequential damage.

The vertical corner joints, sheet joints and the perimeter joints, where the potential for shrinkage and structural movement of the framing is greatest, should be provided with a corner angle or structural blocking behind the wall linings to ensure integrity of the membrane system and reduce stresses in the membrane.

Transition tapes, sealants, bond breakers, etc. will allow the stresses to be accommodated across a larger area of the membrane and alleviate membrane cyclical fatigue or rupture.

NOTE Refer to product specifications for information about selection flashing.

### A.5.4 Prefinished wall panels

Vertical joints between panels and their horizontal junctions with other materials should be carefully considered, as the panels are the only barrier between the water and the framing beneath. All joints between panels should be either flashed or waterproofed with a sealant, and the bottoms of panels installed to overlap adjoining materials.

### A.5.5 Floors

#### A.5.5.1 General

Waterproof barriers prevent downward or sideways movement of water into adjoining construction or rooms.

Water naturally penetrates tiled floor finishes more readily than wall finishes. Where a tile bed is used, a waterproof membrane may be installed above or below the tile bed. Where a membrane is installed above a tile bed, the tile adhesive should be compatible with the membrane.

Where the membrane is under the tile bed, the falls in the membrane are there to move moisture to the leak control flange and into the waste riser [see [Figure 4.3.1\(A\)](#) and [Figure 4.3.1\(B\)](#)].

#### A.5.5.2 Efflorescence

Efflorescence on tile grouts is a white deposit, which develops on the surface of grout and/or tiles as the wet area is drying out. The white powder or darker staining can be caused by soluble salts being present in the jointing material, adhesive-bed, or substrate on which the tiles were fixed, and which migrate out of the bed to the upper surface where they are deposited.

Efflorescence may be caused by excessive soluble salts or the lack of structural falls to outlets or substrate ponding and a failure to design suitable mechanisms to control capillary action in tile beds.

Minor efflorescence may be a part of normal maintenance but excessive deposits over shorter periods of time should be remedied by waterstops, tiling beds with less soluble salts, pore blocking additives, improvement to substrate falls, etc.

Wet area tiling systems are not waterproof but are water resistant and don't prevent the permanent wetting or saturation of their bedding systems during use. This can result in unhygienic conditions such as mould, efflorescence, crypto-florescence and staining.

This may develop on the surface of grout and tiles from the drying and evaporation of construction moisture present in cementitious installation materials (primary efflorescence). It may also develop on

the surface of grout and tiles from the drying and evaporation of non-construction moisture that has accumulated in the tiling installation system (secondary efflorescence).

Primary efflorescence is considered a natural condition of hydraulic cement-based installation systems and is regarded as an aesthetic issue. Secondary efflorescence and crypto (sub)-fluorescence may be regarded as defect design that does not address subsurface drainage and subsurface ponding within the tile bed.

Strategies to mitigate its occurrence include:

- (a) Directing water to outlets by installing membranes with falls to outlets.
- (b) Placing membrane systems as close to the surface finish as possible to isolate as much of the installation system as possible.
- (c) Installing good falls to drain surface water as quickly as possible.
- (d) Using installation materials that don't contain salts that can be put into solution, for example epoxy adhesives and grouts.
- (e) Using impervious surface finishes and jointing materials that resist the transpiration of water.
- (f) Installing finishes to minimize possible voids, cavities or capillaries under them. Refer to AS 3958.1 for coverage information.

#### **A.5.5.3 General requirements of barriers**

To maintain the integrity and durability of the waterproofing system; trays, wall sheeting, timber or steel floor plates or flashing and such like, should be installed in a manner that allows for the normal movements of any supporting structure.

*In situ* membranes and flashings should be able to operate over floor-to-wall and wall-to-wall joints without failing under the forces exerted on them when such movement occurs due to designed floor loads, temperature fluctuations, shrinkage, etc.

For framed construction, prefabricated flashings should be adhered only to the floor, allowing the sides of the vertical legs to accommodate the differential movement between walls and floors.

#### **A.5.5.4 *In situ* barriers — properties and installation**

Some of the materials specified for *in situ* membranes or flashings are not considered sufficiently elastic to stretch without tearing, or flexible enough to bend without breaking when subjected to joint movement. Therefore, such barriers should not be applied directly across the joint, and should be completely bonded to both adjacent surfaces. The correct approach is to first install a bond breaker at junctions and movement joints. This bond breaker may consist of any of the following depending on the class of the membrane:

- (a) A suitable sealant.
- (b) Bond-breaker tape.

The method used should be directly related to the type of membrane installed. More rigid membrane and flashing materials, which bend rather than stretch, are better suited for use with a backing rod and bond-breaker tape.

#### **A.5.5.5 Set-downs**

Vertical edges of the set-downs should align flush with the wall substrate to avoid creating voids, cavities or protrusions. They should be repaired prior to installation of a waterproofing system, as they are the cause of many waterproofing problems.

### A.5.5.6 Tiles within shower area

Small dimension tiles used in shower areas enable the tiler to achieve the necessary fall to the waste. As the size of the tiles increase adequate falls become more difficult to achieve.

## A.6 Design solutions for single floor waste wet areas with linear drains

Figures A.6(A) to A.6(D) show design solutions for single floor waste wet areas with linear drains. Where possible, the design should incorporate waterstops to retain water within the Category 1 area and incorporate membrane systems and additives that mitigate efflorescence and mould growth.

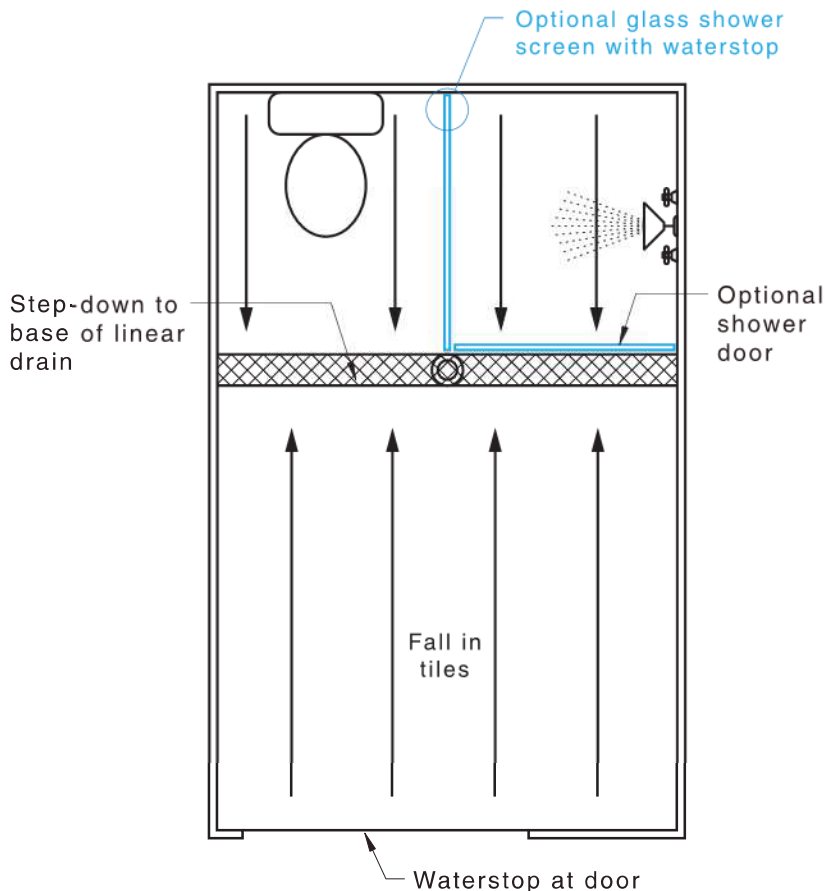
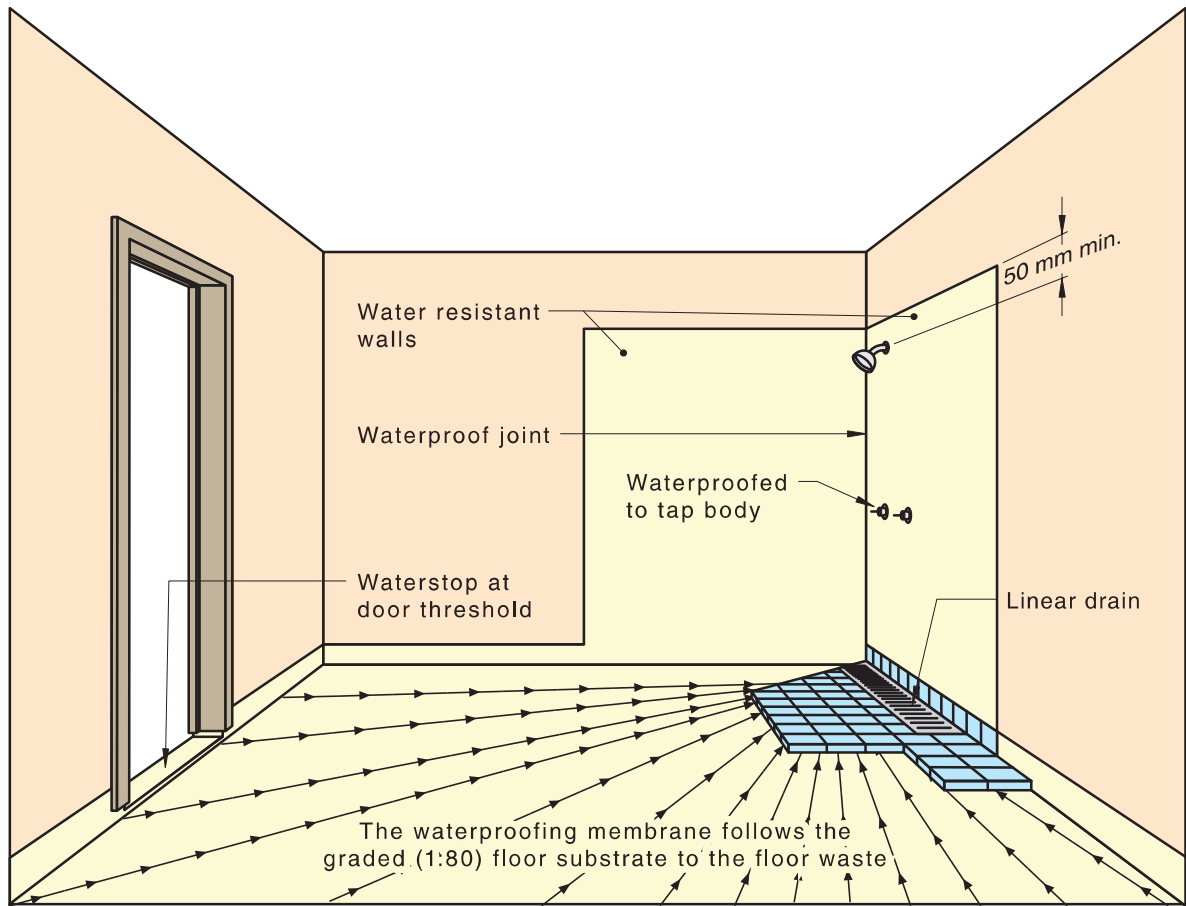
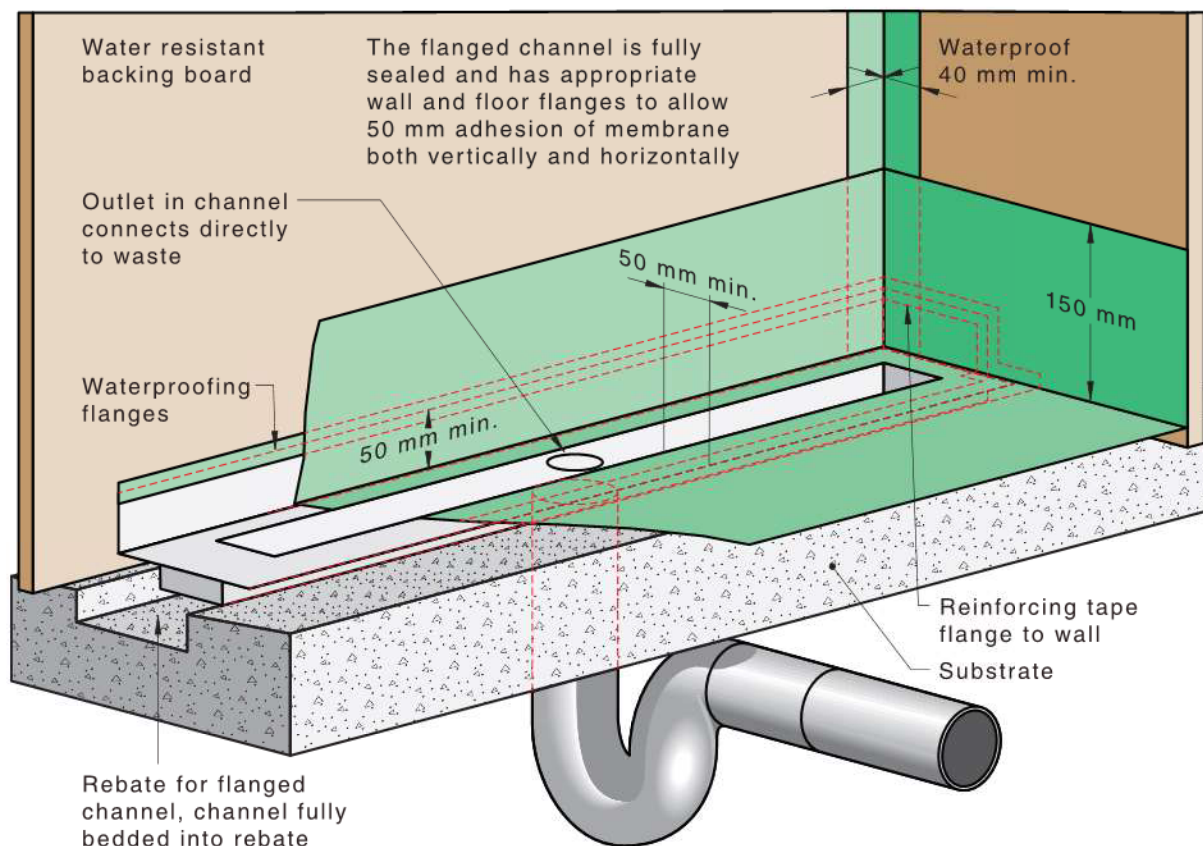


Figure A.6(A) — Whole of bathroom example



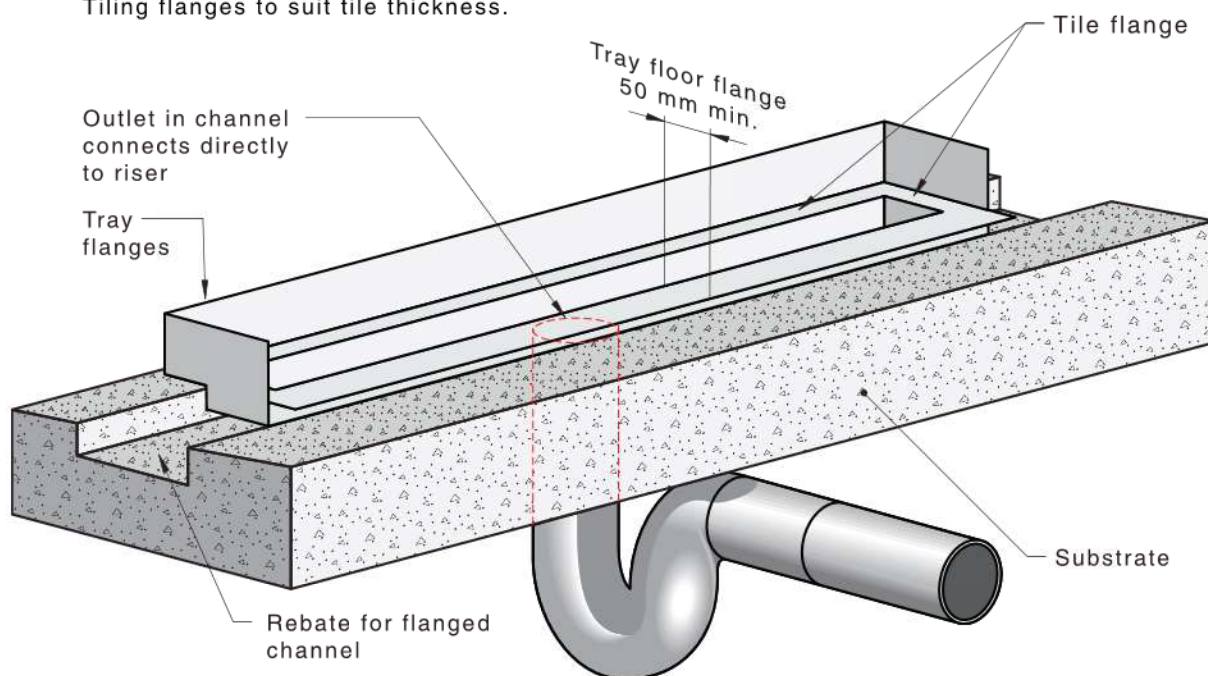
**Figure A.6(B) — Whole of bathroom with linear drain**



**Figure A.6(C) — Custom fabricated flanged channel against a wall**

[SOURCE: Reproduced with permission from Stormtech. All rights reserved]

Fabricated flanged channel for against wall installation.  
 The fabricated channel becomes the floor/wall junction  
 flashing as well as the drainage channel.  
 Flanges for membrane adhesion 50 mm min.  
 Tiling flanges not to be used for waterproofing.  
 Tiling flanges to suit tile thickness.



NOTE Trim should not restrict substrate drainage at linear drain.

**Figure A.6(D) — Fabricated flange components explanatory diagram**

[SOURCE: Reproduced with permission from Stormtech. All rights reserved]

## Appendix B (informative)

### Falls in floor finishes

#### B.1 General

The primary consideration for falls in floor finishes is to ensure water does not remain on the finished floor in a manner that can adversely affect the health or amenity of the occupants or deteriorate building elements.

#### B.2 Factors affecting falls

The ratio of fall achieved in a floor may vary depending upon —

- (a) finished height requirements at doorways;
- (b) height of fixtures or fittings;
- (c) dimensions of the tiles used: adequate falls become more difficult to achieve as the size of the tiles used increases;
- (d) area of the floor to be drained; and
- (e) requirements of persons with disabilities.

#### B.3 Fall ratios

[Clause 2.3.2](#) specifies a fall ratio of 1:80 in shower areas.

Where falls flatter than 1:100 are proposed, the effectiveness of the floor drainage should be confirmed to ensure the primary consideration given in [Clause B.1](#) has been met.

#### B.4 Diagonal cutting of tiles

Tiles may require diagonal cutting in the area around the waste to achieve the required falls, sufficient drainage and to ensure lipping is kept within the guidelines of AS 3958.1.

#### B.5 Determination of ponding

When conditions are suitable for drying and all other associated areas have dried, any remaining accumulation of water is deemed ponding. Water retained by surface tension alone should evaporate within 5 h when local atmospheric conditions are 21 °C, 1 013 hPa, and 50 % relative humidity.

## Appendix C (normative)

### Membrane continuity testing

#### C.1 Scope

This appendix details four methods for membrane continuity testing, as follows:

- (a) Flood test.
- (b) Electronic leak detection test.
- (c) Seam probe test.

#### C.2 Flood test

##### C.2.1 Principle

The area to be tested is filled with water and any reduction in depth measured.

##### C.2.2 Procedure

The test shall be conducted as follows:

- (a) Check that the membrane has achieved full cure.
- (b) Block floor wastes in the pipe using a pipe plug device.
- (c) Using an external water source, fill the wet area floor to the top of the waterstop angle.
- (d) Allow to stand for a minimum of 24 hours.
- (e) Inspect the depth of the water for any reduction in depth below the waterstop angle.
- (f) Inspect the areas adjacent to the wet area for indications of leakage, including any ceilings below, where applicable.
- (g) Check that the membrane and flashing are intact.

NOTE 1 For leak detection, where a hob or waterstop angle divides the shower area from the wet area floor, both areas should be tested independently.

NOTE 2 Use of different dyes should be considered for shower recess and bathroom floor areas.

NOTE 3 Thermal imaging may be utilized to detect water leaks into concealed spaces.

##### C.2.3 Report

The following shall be reported:

- (a) Any reduction in water depth observed over the 24 h period.
- (b) Any observations of leakage.
- (c) If applicable, the discontinuities contributing to the reduction in water depth.

## C.3 Electronic leak detection

### C.3.1 Application

Electronic leak detection methods can be used to locate discontinuities in non-conductive waterproofing membrane applied over a conductive substrate.

An electronic leak detection test is considered to be passed if no electrical conductance points are detected through the waterproofing membrane. Any electrical conductance points identified in the lining are considered to be discontinuities.

### C.3.2 Procedure

The test shall be conducted as follows:

- (a) Check that the surface of the membrane is clean, dry, free of oil, grease, dirt, or other contaminants.
- (b) Scan the waterproofing membrane with electronic leak detection equipment.
- (c) Record any electrical conductance points with a compatible marker.

NOTE 1 The entire membrane should only be tested once. Where subsequent testing is required due to failure and subsequent repair, only the repaired areas should be tested.

NOTE 2 For calibration of equipment and establishing testing parameters before testing, refer to AS 3894.1.

### C.3.3 Report

Any identified points of electrical conductance shall be reported.

## C.4 Seam probe test

### C.4.1 Application

This test relates to welded sheet membranes only.

### C.4.2 Procedure

The test shall be conducted as follows:

- (a) Use a seam probing tool to probe the welded lap joints for seam failure.
- (b) Record the location of any failed laps with a compatible marker.

### C.4.3 Report

Any seam failures detected shall be reported.

## Appendix D (informative)

### Suggested installation checklist

#### D.1 Scope

This appendix provides a suggested checklist of items (see [Table D.1](#)) to be reviewed following installation of waterproofing. It is intended as an example for assistance but is by no means comprehensive.

#### D.2 Checklist

**Table D.1 — Suggested installation checklist**

Item	Complete? Y/N
Substrate	
(i) Floors — Concrete	
Voids filled including formwork distortions with mortar repair compound.	
Protrusions ground down to uniform smooth surface.	
Clean and free of debris and spoil.	
Moisture content tested in accordance with <a href="#">Appendix E</a> .	
(ii) Floors — framed and sheeted:	
Fixings installed in accordance with manufacturer's instructions.	
Sheeting set and sanded in accordance with manufacturer's instructions.	
Clean and free of debris and spoil.	
Substrate condition/preparation documented.	
Waterstops	
Wet area door opening waterstop sealed to substrate.	
Vertical flashing angle extends to shower corners behind wall sheeting.	
Waterstop angles extend to shower recess under shower screen/frameless glass sealed to substrate.	
Drainage control FLANGE	
Floor waste flange recessed and sealed flush to floor substrate.	
Drainage control flange to sanitary plumbing penetrations above floor level.	
Priming/sealant fillets/bond breaker	
Surfaces and walls and floors primed and cured.	
Sealant applied to wall sheet joins in accordance with manufacturer's instructions.	
Sealant fillets and/or bond breaker to wall/floor junctions as specified in AS 4858.	
Sealant fillets and/or bond breaker to wall/wall junctions as specified in AS 4858.	
Waterproofing membrane applied to floor sheet joins in accordance with manufacturer's instructions.	
Preparation documented prior to membrane application.	
Sealing of penetrations	
Tap spindle penetrations sealed with sealant or pre-formed flange.	

**Table D.1** (continued)

	<b>Item</b>	<b>Complete? Y/N</b>
	Shower rose pipe penetrations sealed with sealant or pre-formed flange.	
<b>Waterproof application</b>		
	Waterproofing installed to manufacturer's installation requirements. NOTE: Allow adequate curing time prior to post application inspection.	
	Thickness of the completed membrane application documented.	
<b>Flood testing</b>		
	Floor waste drainage outlet sealed and membrane flood tested.	

## Appendix E (informative)

### Compatibility

#### E.1 General

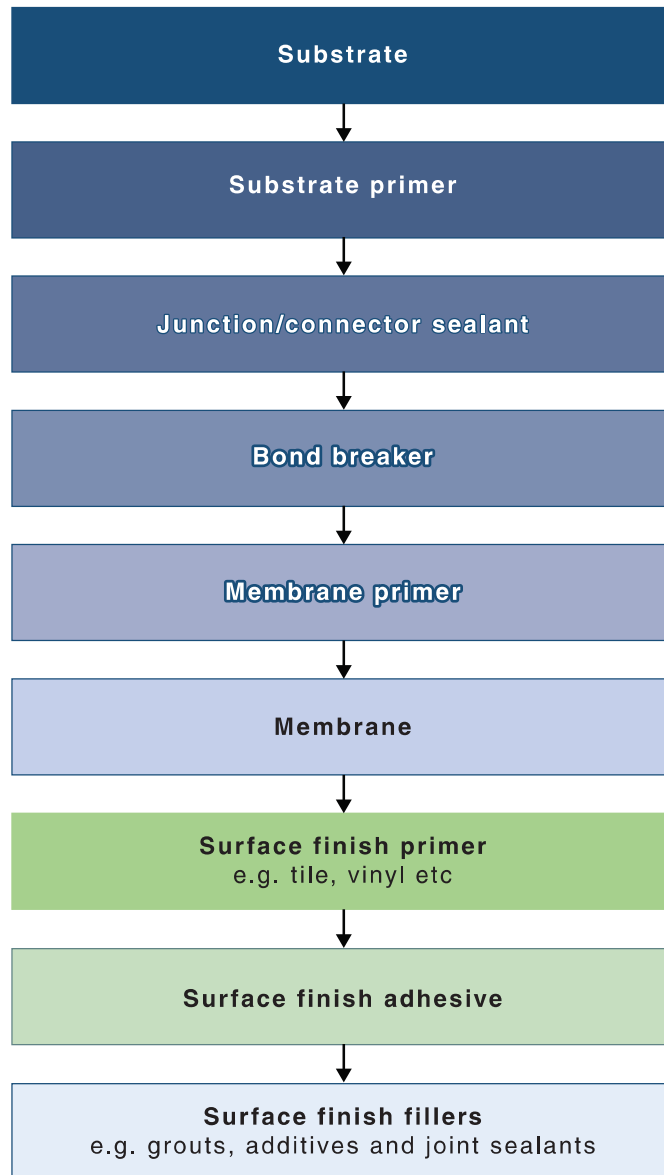
All products in the waterproofing system should be compatible to prevent undesirable outcomes. Incompatibility between components of the system can lead to bubbling, blistering, retarded curing or de-lamination. Consideration should be given to the following elements of a waterproofing system:

- (a) Substrate.
- (b) Waterstop angle.
- (c) Floor waste.
- (d) Primer.
- (e) Bond breakers.
- (f) Fillets.
- (g) Reinforcing bandages.
- (h) Overlay.

#### E.2 Compatibility chain

##### E.2.1 General

Waterproofing components should be compatible in combination to form a waterproofing system according to the design requirements. Components should be water resistant or waterproof and should not compromise the performance of the membrane. Isolating primers/coatings may be used where compatible with both the membrane and other components. Primers for porous and non-porous substrates may differ. See [Figure E.1](#) for a compatibility chain of waterproofing components.



**Figure E.1 — Compatibility chain**

### **E.2.2 Substrate primer**

The selected primer is to prepare the substrate to provide bonding compatibility for application of the membrane. The primer should be chemically compatible with the membrane.

### **E.2.3 Junction/connectors**

Connections of membranes to termination points, junctions and transitions should be compatible with selected sealants and component materials.

### **E.2.4 Bond breaker/fillets**

Bond breakers and fillets should match the elasticity class of the membrane and be chemically compatible with the membrane.

### **E.2.5 System components**

Waterstops, drainage control flanges, fittings and coves should be compatible with the junction/connector sealants or isolated with a selected primer compatible with both the membrane and the junction detail.

### **E.2.6 Membrane**

The membrane should be compatible with the substrate, system components and topical finishes.

### **E.2.7 Surface finish primer**

The membrane should be compatible with selected surface finishes. The membrane may act as the finish substrate, or be treated with a primer, or be treated with an isolation underlayment compatible with the membrane and the surface finish.

### **E.2.8 Surface finish adhesive**

The membrane should be compatible with selected surface finishes. The membrane may act as the finish substrate, or be treated with a primer, or be treated with an isolation underlayment compatible with the membrane and the surface finish. The surface finish adhesive should not compromise the performance of the membrane and subsurface drainage at membrane level. Adhesives should be compatible with the intended use for wet areas.

### **E.2.9 Fillers, welds, grouts and finish sealants**

Should be compatible with the membrane and system components and should not adversely affect the elasticity class of the membrane or subsurface moisture movement.

### **E.2.10 Penetration sealants**

Should be compatible with the membrane and system components and background materials.

## Appendix F (informative)

### Testing for moisture content in subfloors

#### F.1 Background

This appendix is informative only. It is intended to provide guidance only, and does not give rise to a requirement for waterproofing systems to be tested by any of the following options.

Testing of the moisture content of substrates to be treated with a waterproof membrane should be undertaken to ensure that the conditions of the substrate are suitable at the time of waterproofing.

The substrate should not contain excessive moisture which may cause the installed system to become unbonded or damaged.

A number of methods are available, and accompanying standards provide appropriate test methods to be followed. These tests include ASTM F2659, AS/NZS 1080.1 (refer to Section 5) and AS/NZS 2098.1. Where more rigorous testing is required ASTM F2170 may provide more definitive results.

The primary test method to determine moisture content is ASTM F2170. For areas where drilling into the slab is not practical, testing may be undertaken in accordance with the methodology set out in ASTM F1869.

Surface testing of the subfloor provides an indicative measure of the moisture vapour evaporation rate at the time of testing only. A surface test should be carried out for concrete slabs that cannot be tested by drilling (*in situ* probe method), e.g. due to in-floor heating or post tensioned cables.

#### F.2 Testing procedures

##### F.2.1 General

The instrument manufacturer's instructions should be followed when undertaking moisture testing of a concrete slab.

All instruments used in the test procedures are calibrated as specified in manufacturer's instructions and records kept.

##### F.2.2 Concrete subfloors

###### F.2.2.1 Test methods

All tests should be carried out by a competent person.

###### F.2.2.2 Relative humidity (RH) *in situ* probe test (primary test method)

Concrete subfloors are suitable for the installation of waterproof membranes when measurements taken in accordance with ASTM F2170 do not exceed 80 % relative humidity. Three tests should be performed for the first 100 m<sup>2</sup>, and at least one additional test for each additional 100 m<sup>2</sup> at recommended positions in accordance with ASTM F2170.

Prepared test holes should have a minimum of 24 h equilibrium time prior to recording test results.

**NOTE** The RH of 80 % noted above is the default result where the manufacturer of the waterproof membrane, adhesive and preparation materials does not offer a recommended maximum RH in their installation instructions or data sheet. Product specification RH requirements take precedence over the figures noted in this document.

### **F.2.2.3 Moisture vapour emission rate surface test (secondary test method)**

Concrete subfloors should be considered suitable for the installation of waterproof membranes when measurements taken in accordance with ASTM F1869 do not exceed 15 g/m<sup>2</sup>/24 h. Three tests should be performed for the first 100 m<sup>2</sup> and at least one additional test for each additional 100 m<sup>2</sup> at recommended positions in accordance with ASTM F1869.

**NOTE** The 15 g/m<sup>2</sup>/24 hr noted above is the default result where the manufacturer of the waterproof membrane, adhesive and preparation materials does not offer a recommended maximum moisture vapour emission rate (MVER) in their installation instructions or data sheet. The manufacturer's MVER requirements take precedence over the figures noted in this document.

The site conditions for testing should be at the same ambient conditions anticipated during normal everyday use. Should it not be possible to get the test areas to meet these conditions, then the test conditions should be 23.9 ± 5.5 °C and 50 ± 10 % relative humidity. These conditions should be maintained for a minimum of 48 h prior to and during testing.

Test locations should be 500 mm × 500 mm. Test locations should have all existing floor coverings, adhesives, screeds, etc. removed and the surface lightly ground to produce a Concrete Surface Profile (CSP) equal to CSP-1 to CSP-2. The test area should be left open to ambient conditions for a minimum of 24 h prior to the placement of the test kit.

Concrete subfloors that have not had a floor covering, adhesive, etc. installed over them for at least 30 days, or new concrete slabs, can be prepared to CSP-1 or CSP-2 with no waiting period providing the ambient conditions noted in this document have been met.

### **F.2.2.4 Calibration of scale**

Calibration of the scales is critical due to the low weights being measured. Therefore, the Gram Scale, capable of measuring in increments of 0.1 g, should be used to weigh the anhydrous calcium chloride dish.

Prior to the commencement of the test, the measuring scale should be calibrated using a standardized calibration weight. Evidence of the calibrated result should be documented with the test results.

## **F.2.3 Timber and plywood membrane substrates**

Timber and plywood membrane substrates should be considered dry when moisture content measurements are within a range of 10 % to 14 %. Similarly, as for concrete substrates, three tests should be performed for the first 100 m<sup>2</sup> and at least one additional test for each additional 100 m<sup>2</sup>.

Suitable testing procedures for timber subfloors may be found in AS/NZS 1080.1 and for plywood subfloors in AS/NZS 2098.1. AS/NZS 2098.1 electrical resistance measuring method may also be employed.

## **F.2.4 Concrete or cementitious screeds**

The primary quantitative test method to determine moisture content for concrete is ASTM F2170. This test method covers the quantitative determination of percent of relative humidity in concrete slabs for field or laboratory tests. This test method requires the drilling of holes for a probe to be inserted and readings taken. For areas where drilling into the slab is not practical, testing should be undertaken in accordance with the methodology set out in ASTM F1869.

ASTM F2659 non-destructive surface testing of the subfloor will provide a comparative moisture condition within the upper 25 mm stratum in concrete, anhydrite floor slabs and screeds for field tests, at the time of testing only. A surface test should be carried out for concrete slab substrates that cannot be tested by drilling (*in situ* probe method), e.g. due to in-floor heating or post tensioned cables.

### F.3 Calibration of testing equipment

Test equipment for the use of determining relative humidity or comparative moisture content of substrates should be calibrated to the substrate under test. Test equipment should be tested and verified for accuracy as required by the equipment manufacturer.

### F.4 Test report

The value of adequate moisture testing is often not realized until a problem arises with an installation sometime after completion. Accordingly, written records of moisture testing results should capture the following:

- (a) Physical address of subfloor tested.
- (b) Type of subfloor tested.
- (c) Testing regime.
- (d) Date and time of measurements taken.
- (e) Location of testing equipment.
- (f) Results of readings taken.
- (g) Subfloor temperature and relative humidity at time of test results.
- (h) Ambient temperature and relative humidity at time of test results.
- (i) Type, make, model and serial number of the test equipment and its calibration status.

## Bibliography

- AS 1428.1, *Design for access and mobility, Part 1: General requirements for access—New building work*
- AS 3500 (all parts), *Plumbing and drainage*
- AS 3894.1, *Site testing of protective coatings, Method 1: Non-conductive coatings—Continuity testing—High voltage (brush) method*
- AS 3894.3, *Site testing of protective coatings, Method 3: Determination of dry film thickness*
- AS 3958.1, *Ceramic tiles, Part 1: Guide to the installation of ceramic tiles*
- AS/NZS 1080.1, *Timber—Methods of test, Method 1: Moisture content*
- AS/NZS 2098.1, *Methods of test for veneer and plywood, Method 1: Moisture content of veneer and plywood*
- ASTM F1869, *Standard Test Method for Measuring Moisture Vapor Emission Rate of Concrete Subfloor Using Anhydrous Calcium Chloride*
- ASTM F2170, *Standard Test Method for Determining Relative Humidity in Concrete Floor Slabs Using in situ Probes*
- ASTM F2659, *Standard Guide for preliminary Evaluation of Comparative Moisture Condition of concrete, Gypsum cement and other floor slabs and screeds using a Non-Destructive Electronic Moisture Meter*

## NOTES

### **Standards Australia**

Standards Australia develops Australian Standards® and other documents of public benefit and national interest. These Standards are developed through an open process of consultation and consensus, in which all interested parties are invited to participate. Through a Memorandum of Understanding with the Commonwealth Government, Standards Australia is recognized as Australia's peak non-government national standards body.

For further information visit [www.standards.org.au](http://www.standards.org.au)

### **Australian Standards®**

Committees of experts from industry, governments, consumers and other relevant sectors prepare Australian Standards. The requirements or recommendations contained in published Standards are a consensus of the views of representative interests and also take account of comments received from other sources. They reflect the latest scientific and industry experience. Australian Standards are kept under continuous review after publication and are updated regularly to take account of changing technology

### **International Involvement**

Standards Australia is responsible for ensuring the Australian viewpoint is considered in the formulation of International Standards and that the latest international experience is incorporated in national Standards. This role is vital in assisting local industry to compete in international markets. Standards Australia represents Australia at both the International Organization for Standardization (ISO) and the International Electrotechnical Commission (IEC).



GPO Box 476 Sydney NSW 2001  
Phone (02) 9237 6000  
mail@standards.org.au  
www.standards.org.au