



Share your feedback about this standard. Scan the QR code on your phone or click/ enter the link to take the survey feedback.standards.org.au/3959:2018

AS 3959:2018
(Incorporating Amendment Nos 1 and 2)

AS 3959:2018



Construction of buildings in bushfire-prone areas



This Australian Standard® was prepared by Committee FP-020, Construction of Buildings in Bushfire-Prone Areas. It was approved on behalf of the Council of Standards Australia on 23 October 2018.

This Standard was published on 14 November 2018.

The following are represented on Committee FP-020:

- Australasian Fire and Emergency Service Authorities Council (AFAC)
 - Australian Building Codes Board
 - Australian Garage Door Association
 - Australian Institute of Architects
 - Australian Institute of Building Surveyors
 - Australian Roofing Tile Association
 - Australian Steel Institute
 - Australian Window Association
 - Bushfire Building Council of Australia
 - Consumers Federation of Australia
 - Department of Health and Human Services, Vic.
 - Fire Protection Association Australia
 - Forest and Wood Products Australia
 - Housing Industry Association
 - Insulated Panel Council Australasia
 - Insurance Council of Australia
 - Master Builders Australia
 - Roofing Tile Association of Australia
 - Think Brick Australia
 - Timber Preservers Association of Australia
 - Window and Door Industry Council
-

This Standard was issued in draft form for comment as DR AS 3959:2018.

Standards Australia wishes to acknowledge the participation of the expert individuals that contributed to the development of this Standard through their representation on the Committee and through the public comment period.

Keeping Standards up-to-date

Australian Standards® are living documents that reflect progress in science, technology and systems. To maintain their currency, all Standards are periodically reviewed, and new editions are published. Between editions, amendments may be issued.

Standards may also be withdrawn. It is important that readers assure themselves they are using a current Standard, which should include any amendments that may have been published since the Standard was published.

Detailed information about Australian Standards, drafts, amendments and new projects can be found by visiting www.standards.org.au

Standards Australia welcomes suggestions for improvements, and encourages readers to notify us immediately of any apparent inaccuracies or ambiguities. Contact us via email at mail@standards.org.au, or write to Standards Australia, GPO Box 476, Sydney, NSW 2001.

Australian Standard®

Construction of buildings in bushfire-prone areas

Originated as AS 3959—1991.
Previous edition 2009.
Fourth edition AS 3959:2018.
Reissued incorporating Amendment No. 1 (June 2019).
Reissued incorporating Amendment No. 2 (December 2020).

COPYRIGHT

© Standards Australia Limited

All rights are reserved. No part of this work may be reproduced or copied in any form or by any means, electronic or mechanical, including photocopying, without the written permission of the publisher, unless otherwise permitted under the Copyright Act 1968.

ISBN 978 1 76072 253 1

PREFACE

This Standard was prepared by the Standards Australia Committee FP-020, Construction of Buildings in Bushfire-Prone Areas, to supersede AS 3959—2009.

This Standard incorporates Amendment No. 1 (June 2019) and Amendment No. 2 (December 2020). The changes required by the Amendment are indicated in the text by a marginal bar and amendment number against the clause, note, table, figure or part thereof affected.

This edition incorporates the following changes:

- (a) The site assessment in Section 2 has been simplified to address interpretational issues related to slope, grasslands and low threat vegetation.
- (b) Section 3 clarifies that the shielding concessions relate only to the elements of the wall and do not apply to the subfloor or roofs.
- (c) The protection of gaps and openings has been addressed by requiring suitable measures for doors and windows and providing for other gaps to be suitably sealed.
- (d) The requirements for floors at BAL-12.5 and BAL-19 relating to bearers, joists and flooring within 400 mm above finished ground level now align with BAL-29.
- (e) Windows address the framed material, hardware, glazing, seals and weather strips and screens. Doors address the door panel material, door frame material, hardware, glazing, seals and weather proofing, screens and to be tight fitting. Vehicle access doors recognise that guide tracks do not permit direct access for embers and do not require edge gap protection. Where specified, weather strips are to conform with a flammability index not greater than 5 (AS 1530.2).
- (f) Roofs can now include certain translucent or transparent roof coverings at BAL-12.5 and BAL-19 for verandas, carports or awnings where the roof is separated from the main building.
- (g) Editorial changes have been made for consistency with Section 2 and to locate tables with the relevant sections of the site assessment methodology. Appendices F and H have been combined.

The terms ‘normative’ and ‘informative’ have been used in this Standard to define the application of the appendix to which they apply. A ‘normative’ appendix is an integral part of a Standard, whereas an ‘informative’ appendix is only for information and guidance.

The use of Notes in this Standard is of an advisory nature only. They provide explanations and guidance on recommended design considerations or technical procedures, as well as an informative cross-reference to other documents or publications.

This Standard incorporates a Commentary on some clauses. The Commentary directly follows the relevant clause, is designated by ‘C’ preceding the clause number and is printed in italics in a panel. The Commentary is for information only and does not need to be followed for conformance with the Standard.

CONTENTS

	<i>Page</i>
FOREWORD.....	5
SECTION 1 SCOPE AND GENERAL	
1.1 SCOPE.....	6
1.2 OBJECTIVE.....	6
1.3 APPLICATION.....	7
1.4 NORMATIVE REFERENCES.....	7
1.5 DEFINITIONS.....	8
1.6 PROCESS OF DETERMINING CONSTRUCTION REQUIREMENTS.....	10
1.7 BUSHFIRE ATTACK LEVELS (BALs).....	11
SECTION 2 DETERMINING THE BUSHFIRE ATTACK LEVEL (BAL)	
2.1 GENERAL.....	13
2.2 SIMPLIFIED PROCEDURE (METHOD 1).....	13
SECTION 3 GENERAL CONSTRUCTION REQUIREMENTS	
3.1 GENERAL.....	33
3.2 CONSTRUCTION REQUIREMENTS FOR SPECIFIC STRUCTURES.....	33
3.3 EXTERNAL MOULDINGS.....	35
3.4 HIGHER LEVELS OF CONSTRUCTION.....	35
3.5 REDUCTION IN CONSTRUCTION REQUIREMENTS DUE TO SHIELDING.....	36
3.6 VENTS, WEEPHOLES, GAPS AND SCREENING MATERIAL.....	38
3.7 BUSHFIRE SHUTTERS.....	39
3.8 TESTING OF MATERIAL, ELEMENTS OF CONSTRUCTION AND SYSTEMS TO THE AS 1530.8 SERIES.....	40
3.9 GLAZING.....	40
3.10 SARKING.....	41
3.11 TIMBER LOG WALLS.....	41
SECTION 4 BUSHFIRE ATTACK LEVEL LOW (BAL—LOW).....	
43	
SECTION 5 CONSTRUCTION REQUIREMENTS FOR BAL—12.5	
5.1 GENERAL.....	43
5.2 SUB-FLOOR SUPPORTS.....	43
5.3 FLOORS.....	43
5.4 WALLS.....	44
5.5 EXTERNAL GLAZED ELEMENTS, ASSEMBLIES AND DOORS.....	45
5.6 ROOFS (INCLUDING PENETRATIONS, EAVES, FASCIAS AND GABLES, AND GUTTERS AND DOWNPIPES).....	48
5.7 VERANDAS, DECKS, STEPS AND LANDINGS.....	50
5.8 WATER AND GAS SUPPLY PIPES.....	52
SECTION 6 CONSTRUCTION REQUIREMENTS FOR BAL—19	
6.1 GENERAL.....	53
6.2 SUB-FLOOR SUPPORTS.....	53
6.3 FLOORS.....	53
6.4 WALLS.....	54
6.5 EXTERNAL GLAZED ELEMENTS, ASSEMBLIES AND DOORS.....	55

	<i>Page</i>
6.6 ROOFS (INCLUDING PENETRATIONS, EAVES, FASCIAS AND GABLES, AND GUTTERS AND DOWNPIPES).....	59
6.7 VERANDAS, DECKS, STEPS AND LANDINGS.....	61
6.8 WATER AND GAS SUPPLY PIPES	63
SECTION 7 CONSTRUCTION REQUIREMENTS FOR BAL—29	
7.1 GENERAL.....	64
7.2 SUB-FLOOR SUPPORTS	64
7.3 FLOORS.....	64
7.4 WALLS	65
7.5 EXTERNAL GLAZED ELEMENTS, ASSEMBLIES AND DOORS	66
7.6 ROOFS (INCLUDING PENETRATIONS, EAVES, FASCIAS AND GABLES, AND GUTTERS AND DOWNPIPES).....	69
7.7 VERANDAS, DECKS, STEPS AND LANDINGS.....	71
7.8 WATER AND GAS SUPPLY PIPES	73
SECTION 8 CONSTRUCTION REQUIREMENTS FOR BAL—40	
8.1 GENERAL.....	74
8.2 SUB-FLOOR SUPPORTS	74
8.3 FLOORS.....	74
8.4 WALLS	75
8.5 EXTERNAL GLAZED ELEMENTS, ASSEMBLIES AND DOORS	75
8.6 ROOFS (INCLUDING PENETRATIONS, EAVES, FASCIAS AND GABLES, AND GUTTERS AND DOWNPIPES).....	78
8.7 VERANDAS, DECKS, STEPS AND LANDINGS.....	80
8.8 WATER AND GAS SUPPLY PIPES	81
SECTION 9 CONSTRUCTION REQUIREMENTS FOR BAL—FZ	
9.1 GENERAL.....	82
9.2 SUB-FLOOR SUPPORTS	82
9.3 FLOORS.....	82
9.4 WALLS	83
9.5 EXTERNAL GLAZED ELEMENTS, ASSEMBLIES AND DOORS	83
9.6 ROOFS (INCLUDING PENETRATIONS, EAVES, FASCIAS AND GABLES, AND GUTTERS AND DOWNPIPES).....	85
9.7 VERANDAS, DECKS, STEPS AND LANDINGS.....	87
9.8 WATER AND GAS SUPPLY PIPES	88
APPENDICES	
A WORKED EXAMPLE FOR THE ASSESSMENT OF BUSHFIRE ATTACK LEVEL (BAL)	89
B DETAILED METHOD FOR DETERMINING THE BUSHFIRE ATTACK LEVEL (BAL)—METHOD 2	91
C PROCESS AND PROCEDURE FOR DETERMINING THE BUSHFIRE ATTACK LEVEL (BAL) USING METHOD 1	105
D ILLUSTRATIONS.....	106
E TIMBER SPECIES AND DENSITIES	111
F BUSHFIRE-RESISTING TIMBER	115
G EXPLANATION OF BUSHFIRE ATTACK LEVELS (BALs).....	117
H GENERIC ROOF SYSTEMS	119
BIBLIOGRAPHY.....	124

FOREWORD

This Standard is primarily concerned with improving the ability of buildings in designated bushfire-prone areas to better withstand attack from bushfire thus giving a measure of protection to the building occupants (until the fire front passes) as well as to the building itself.

Improving the design and construction of buildings to minimize damage from the effects of bushfire is but one of several measures available to property owners and occupiers to address damage during bushfire. Property owners should be aware that this Standard is part of a process that aims to lessen the risk of damage to buildings occurring in the event of the onslaught of bushfire. Other measures of mitigating damage from bushfire fall within the areas of planning, subdivision, siting, building design, landscaping and maintenance.

Research is continuing with regards to the effects of bushfires on buildings, determination of bushfire-prone areas within various States and Territories and particular construction techniques designed to maximize the performance of buildings when subjected to bushfire attack. The outcomes of this research will be reflected in subsequent editions of this Standard.

The measures set out in this Standard to improve construction, and thus better equip a building to withstand the effects from bushfire, may also be used as a guide for those who wish to voluntarily adopt such measures in situations where regulatory compliance is not mandated.

Although this Standard provides for the highest Bushfire Attack Level (BAL), that is, BAL—FZ, there may be circumstances advised by authorities having jurisdiction that building in a particular bushfire location is either not recommended or not permitted based on unrealistic risk exposures.

Of significance to this Standard is the publication of methods of test in the AS 1530.8 series. Building materials, elements of construction and systems subjected to the tests of the AS 1530.8 series will satisfy the construction requirements prescribed in Sections 5 to 9 of this Standard. These methods are AS 1530.8.1, *Methods for fire tests on building materials, components and structures, Part 8.1: Tests on elements of construction for buildings exposed to simulated bushfire attack—Radiant heat and small flaming sources* and AS 1530.8.2, *Methods for fire tests on building materials, components and structures, Part 8.2: Tests on elements of construction for buildings exposed to simulated bushfire attack—Large flaming sources*.

The modelling procedure for the assessment of BAL in this Standard uses the nominal inputs shown in Appendix B, Table B1 with an assumed flame temperature of 1090 K. The outputs result in the production of Tables 2.4 to 2.7.

It should be borne in mind that the measures contained in this Standard cannot guarantee that a building will survive a bushfire event on every occasion. This is substantially due to the degree of vegetation management, the unpredictable nature and behaviour of fire, and extreme weather conditions.

The survivability of buildings is also dependent on a combination of measures such as landscaping, water supplies, access, building design and maintenance. Care should also be exercised when siting and designing for these measures when constructing a building under this Standard.

STANDARDS AUSTRALIA

Australian Standard

Construction of buildings in bushfire-prone areas

SECTION 1 SCOPE AND GENERAL

1.1 SCOPE

This Standard specifies requirements for the construction of buildings in bushfire-prone areas in order to improve their resistance to bushfire attack from burning embers, radiant heat, flame contact and combinations of the three attack forms.

Although this Standard is designed to improve the performance of buildings when subjected to bushfire attack in designated bushfire-prone areas there can be no guarantee that a building will survive a bushfire event on every occasion. This is substantially due to the unpredictable nature and behaviour of fire and extreme weather conditions.

This Standard does not provide any requirements for fencing and screen walls. Fencing and screen walls may reduce exposure of a building to embers, radiant heat and flame contact from the bushfire front and from other potential fire sources such as adjacent buildings. The efficacy of fencing and walls depends on its resistance to ember, radiant heat and flame attack and potential for ignition and subsequent sustained flaming, height and structural design and specific site configurations. Therefore no specific advice has been provided in this Standard but designers may consider utilizing fencing and walls to improve house survivability beyond the base levels provided in this Standard.

NOTES:

- 1 The construction measures contained in this Standard apply to any building class and are not the only measures that can be considered to address bushfire attack as there are other means available that are outside the scope of this Standard.
- 2 This Standard does not address the infiltration of smoke nor any associated health and safety risk. The combustion of material and coatings during a bushfire may present a health and safety risk. Selection of external material should be considered in relation to potential health and safety risk in a bushfire.
- 3 The vulnerability of a building is also affected by building design and maintenance. The provision of water, access and landscaping is also important but falls outside the scope of this Standard. The overall survivability of a building is dependent on a combination of these measures in achieving improved safety.

A2

1.2 OBJECTIVE

1.2.1 Objective of this Standard

The objective of this Standard is to prescribe particular construction details for buildings to reduce the risk of ignition from a bushfire, appropriate to the—

- (a) potential for ignition caused by burning embers, radiant heat or flame generated by a bushfire; and
- (b) intensity of the bushfire attack on the building.

1.2.2 Objective of this edition

The objective of this edition is to provide additional and detailed methods of assessing bushfire attack together with the applicable construction requirements, arranged by BAL.

1.3 APPLICATION

This Standard is limited to those sites where the Bushfire Attack Level (BAL) has been determined as BAL—LOW, BAL—12.5, BAL—19, BAL—29, BAL—40 or BAL—FZ (see Table 3.1).

NOTE: Although there are no specific construction requirements in the BAL designated as LOW, this does not imply these buildings are not at risk.

1.4 NORMATIVE REFERENCES

The following documents are indispensable to the application of this Standard.

NOTE: Documents referenced for informative purposes are listed in the Bibliography.

AS

- 1288 Glass in buildings—Selection and installation
- 1445 Hot-dipped zinc-coated, aluminium/zinc-coated or aluminium/zinc/magnesium-coated steel sheet—76 mm pitch corrugated
- 1530 Methods for fire tests on building materials, components and structures
- 1530.1 Part 1: Combustibility test for materials
- 1530.2 Part 2: Test for flammability of materials
- 1530.4 Part 4: Fire-resistance test of elements of construction
- 1530.8.1 Part 8.1: Tests on elements of construction for buildings exposed to simulated bushfire attack—Radiant heat and small flaming sources
- 1530.8.2 Part 8.2: Tests on elements of construction for buildings exposed to simulated bushfire attack—Large flaming sources
- 1684 Residential timber-framed construction (series)

A2

‘Text deleted’

- 1905 Components for the protection of openings in fire-resistant walls
- 1905.1 Part 1: Fire-resistant doorsets
- 2047 Windows and external glazed doors in buildings
- 2049 Roof tiles
- 2050 Installation of roof tiles
- 3999 Bulk thermal insulation—Installation

AS/NZS

- 2588 Gypsum plasterboard
- 3837 Method of test for heat and smoke release rates for materials and products using an oxygen consumption calorimeter

A2

‘Text deleted’

- 4859 Materials for the thermal insulation of buildings
- 4859.1 Part 1: General criteria and technical provisions
- 60335 Household and similar electrical appliances—Safety
- 60335.2.98 Part 2.98: Particular requirements for humidifiers (IEC 60335-2-98 Ed 2.2, MOD)

ASTM

- D2898 Standard Practice for Accelerated Weathering of Fire-Retardant-Treated Wood for Fire Testing

- NCC National Construction Code

1.5 DEFINITIONS

For the purpose of this Standard, the definitions below apply.

1.5.1 Bushfire

An unplanned fire burning in vegetation; also referred to as wildfire.

1.5.2 Bushfire attack

Attack by wind, burning embers, radiant heat or flame generated by a bushfire.

1.5.3 Bushfire-prone area

An area that is subject to, or likely to be subject to, bushfire attack.

1.5.4 Bushfire Attack Level (BAL)

A means of measuring the severity of a building's potential exposure to ember attack, radiant heat and direct flame contact, using increments of radiant heat expressed in kilowatts per metre squared, and the basis for establishing the requirements for construction to improve protection of building elements from attack by bushfire.

1.5.5 Bushfire-resisting timber

Timber that is in solid, laminated or reconstituted form that meets the test specified in Appendix F.

1.5.6 Bushfire shutter

A shutter that is constructed and fitted to the exterior of a building in accordance with Clause 3.7, to protect a window or a door from exposure to bushfire attack.

1.5.7 Classified vegetation

Vegetation that has been classified in accordance with Clause 2.2.3.

1.5.8 Combustible

Combustible as determined by AS 1530.1.

1.5.9 Decking

That part of the structure of verandas, decks, steps, ramps and landings that forms the trafficable surface of the structure.

1.5.10 Door frame

A2 | The frame surrounding and supporting a door where the frame consists of two jambs, a head and sometimes a transom and a sill, and is machined or made from solid stock or with a planted doorstep (see Figure 3.2).

1.5.11 Effective slope

The slope under that classified vegetation which most influences the bushfire attack (see Figure 2.3).

1.5.12 Ember attack

A2 | Attack by smouldering or flaming windborne debris that is capable of entering or accumulating around a building, and that may ignite the building or other combustible material and debris.

1.5.13 Ember guard

A cover inserted in or over an opening or cavity to prevent the entry of burning embers.

1.5.14 Fire Danger Index (FDI)

The chance of a fire starting, its rate of spread, its intensity and the difficulty of its suppression, according to various combinations of air temperature, relative humidity, wind speed and both the long- and short-term drought effects.

NOTES:

- 1 FDI in this Standard refers to the Forest Fire Danger Index calculated by the McArthur Mk 5 Forest Fire Danger Meter using the equations published by Noble, I.R., Bary, G.A.V, and Gill, A.M., 1980 (Ref. 5, Appendix B).
- 2 Grassland Fire Danger Index values are calculated by the McArthur Mk 4 Grassland Fire Danger Meter using the equations published by Purton, C.M., 1982 (Ref. 6 and Commentary CB2, Appendix B).

1.5.15 Fire resistance level (FRL)

The nominal grading period, in minutes, that is determined by subjecting a specimen to the standard time temperature curve regime as set out in AS 1530.4, to specify—

- (a) structural adequacy,
- (b) integrity, and
- (c) insulation,

which are expressed in that order.

NOTE: For example, a building element with an FRL of 120/60/30 will maintain, when tested in accordance with AS 1530.4—

- (a) structural adequacy for a period of 120 min;
- (b) integrity for a period of 60 min; and
- (c) insulation for a period of 30 min.

1.5.16 Fire-resistant sealant

A sealant that has achieved an FRL of at least -/60/- when tested in accordance with AS 1530.4.

1.5.17 Flame temperature

The assumed effective flame temperature sustained for a 2 minute period over a fire front width of 100 m. Instantaneous flame temperature may peak above 1090 K.

1.5.18 Flame Zone (FZ)

The highest level of bushfire attack as a consequence of direct exposure to flames from the fire front in addition to heat flux and ember attack.

1.5.19 Flammability index

The index number as determined by AS 1530.2.

1.5.20 Foliage cover

The proportion of the ground that would be shaded by foliage when the sun is shining directly overhead, expressed as a percentage for each stratum or identifiable layer of vegetation.

1.5.21 Glazed elements and/or assemblies

Any combination of glass and any other material that fills a window or door opening; also known as a glazing system. This includes but is not limited to: glazed louvres, window walls with one-piece framing elements, faceted glazing, fin-supported glazing and partly and unframed glass assemblies.

1.5.22 Metal-reinforced uPVC

uPVC applied to a continuous metal frame such that if the uPVC fell away no gaps greater than 2 mm would form and the glass pane would continue to be supported.

1.5.23 Non-combustible

Not deemed combustible as determined by AS 1530.1 or not deemed combustible in accordance with the NCC.

1.5.24 Overstorey

The canopy, being the tallest stratum of the vegetation profile.

1.5.25 Relevant authority

An independent agency authorized by legislation or regulation to issue determinations, orders, or other instructions in respect of any subject covered by this Standard.

1.5.26 Resistance to the incipient spread of fire (in respect of a floor system)

The ability of the membrane to insulate and thereby limit the rise in temperature of the combustible elements of the floor system to a level that will not permit the rapid and general spread of fire throughout the floor system and to any adjoining fire compartments, in accordance with AS 1530.4.

1.5.27 Sarking

A material (such as a reflective foil or other membrane) that is normally used for a purpose such as water proofing, vapour proofing, breathing (vapour permeable), or thermal reflectance, and which conforms with Clause 3.10.

1.5.28 Shall

Indicates a mandatory requirement.

1.5.29 Should

Indicates a recommendation or that which is advisory but not mandatory.

1.5.30 Site

The part of the allotment of land on which a building stands or is to be erected.

1.5.31 Total fuel

The sum of the understorey and overstorey fuel loads within classified vegetation.

1.5.32 Understorey

The vegetation beneath the overstorey.

1.6 PROCESS OF DETERMINING CONSTRUCTION REQUIREMENTS

The process for determining construction requirements is diagrammatically shown in Figure 1.1.

CI.6 Before construction requirements covered by this Standard can be determined, it is first necessary to determine the Bushfire Attack Level (BAL) by an assessment of the subject allotment and classified vegetation impacting on the site. Assessment methodologies are provided in Section 2 and Appendices B and C. The assessment outcomes are expressed in BALs and radiant heat levels provide the range on which the construction requirements are based.

1.7 BUSHFIRE ATTACK LEVELS (BALs)

The following BALs, based on heat flux exposure thresholds (see Table 3.1), are used in this Standard:

- (a) BAL—LOW
- (b) BAL—12.5
- (c) BAL—19
- (d) BAL—29
- (e) BAL—40
- (f) BAL—FZ

NOTE: See Appendix G for a description of the threats associated with each BAL.

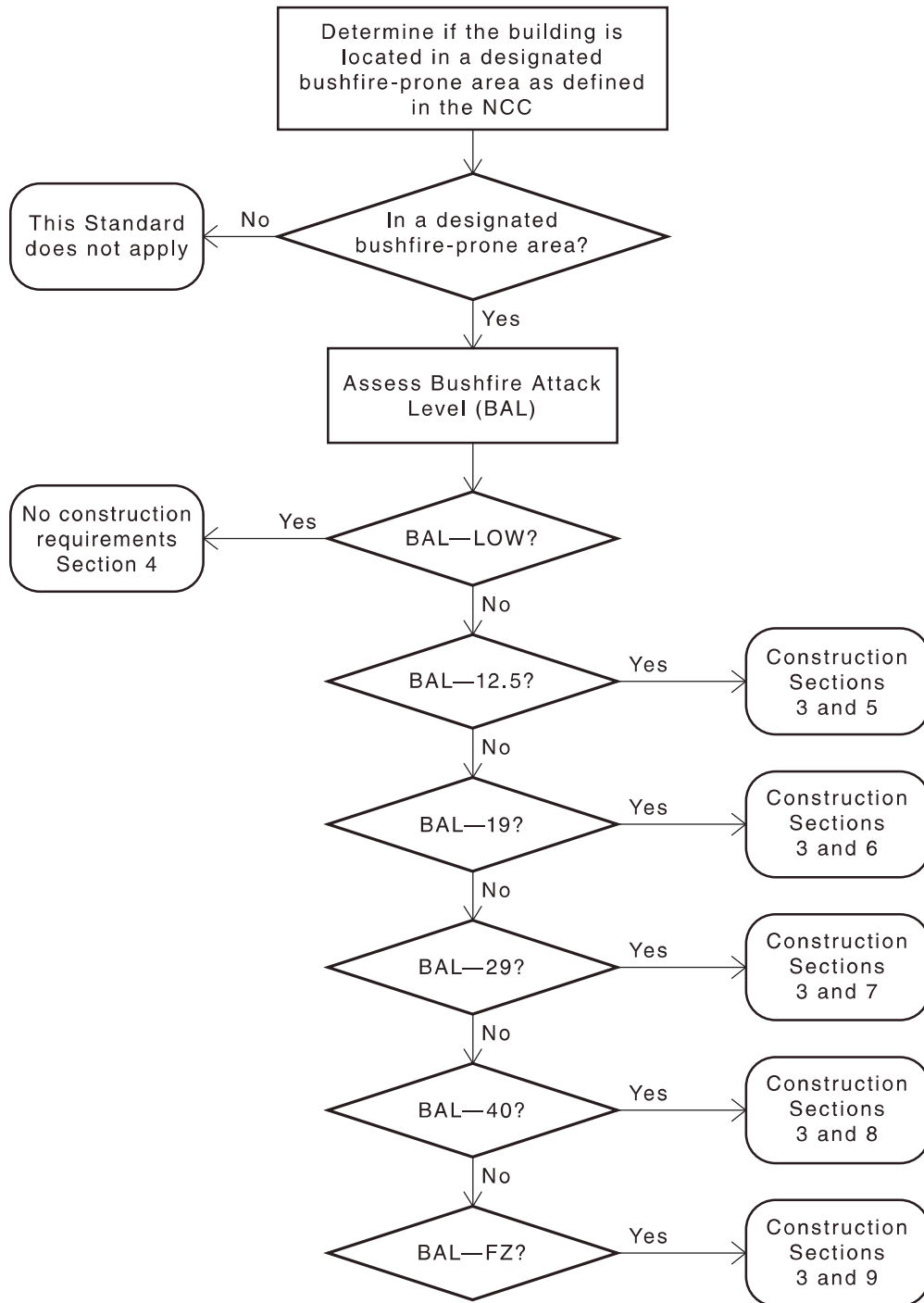

FIGURE 1.1 FLOW DIAGRAM SHOWING THE PROCESS FOR DETERMINING CONSTRUCTION REQUIREMENTS

SECTION 2 DETERMINING THE BUSHFIRE ATTACK LEVEL (BAL)

2.1 GENERAL

The BAL shall apply to the entire building and to any attached or adjacent structures within 6 metres of the building. It shall be determined by using the—

- (a) simplified procedure described in Clause 2.2 (Method 1); or
NOTE: See Appendix C for a flow diagram to summarize the process.
- (b) detailed procedure described in Appendix B (Method 2).

BALs are based on levels of exposure defined in Table 3.1.

C2.1 *There are two methods for determining BALs:*

Method 1—A simplified procedure that involves five steps to determine BALs, which is subject to limitations on the circumstances in which it can be used (see Appendix C).

Method 2—A detailed procedure, set out in Appendix B, using calculations to determine BALs, appropriate where a more specific result is sought or where the site conditions are outside of the scope of Method 1.

BALs are used to determine which, if any, construction requirements contained in Sections 3 to 9 of this Standard are appropriate for a particular site.

2.2 SIMPLIFIED PROCEDURE (METHOD 1)

2.2.1 General

For Method 1, the following steps shall be used to determine the BAL for all circumstances except where the effective slope under the classified vegetation, determined in accordance with Clause 2.2.5, is more than 20° downslope.

The steps are summarized below, with specific requirements provided in the following clauses.

Step	Clause	Procedure
Step 1	2.2.2	Determine the relevant FDI (see Table 2.1).
Step 2	2.2.3	Determine the classified vegetation type(s) (see Table 2.3 and Figure 2.4).
Step 3	2.2.4	Determine the distance of the site from the classified vegetation type(s) [(Point A to Point B; see Figure 2.1)].
Step 4	2.2.5	Determine the effective slope(s) under the classified vegetation type(s) (see Figure 2.3).
A2 Step 5	2.2.6	Determine the BAL from the appropriate table (see Tables 2.4, 2.5, 2.6, and 2.7).
Step 6	2.2.7	Determine the appropriate construction requirements.

2.2.2 Step 1—Relevant Fire Danger Index (FDI)

The relevant FDI shall be determined in accordance with Table 2.1 for the identified jurisdiction or region within a jurisdiction.

TABLE 2.1
JURISDICTIONAL AND REGIONAL VALUES FOR FDI ⁽¹⁾

State/region	FDI
Australian Capital Territory	100
New South Wales	
(a) Greater Hunter, Greater Sydney, Illawarra/Shoalhaven, Far South Coast and Southern Ranges fire weather districts ⁽²⁾	100
(b) NSW alpine areas ⁽³⁾	50
(c) NSW general (excluding alpine areas, Greater Hunter, Greater Sydney, Illawarra/Shoalhaven, Far South Coast and Southern Ranges fire weather districts)	80
Northern Territory	40
Queensland	40
South Australia	80
Tasmania	50
Victoria	
(a) Victoria alpine areas ⁽³⁾	50
(b) Victoria general (excluding alpine areas)	100
Western Australia	80

NOTES:

- 1 The FDI values may be able to be refined within a jurisdiction or region where sufficient climatological data is available and in consultation with the relevant authority.
- 2 Example of NSW general fire weather areas refer to <http://www.bom.gov.au/nsw/forecasts/fire-forecasts.shtml>
- 3 Alpine areas are defined as per the National Construction Code (NCC) of Australia, Volume Two.

2.2.3 Step 2—Vegetation classification types

2.2.3.1 General

Vegetation shall be classified in accordance with Table 2.3. Where there is more than one vegetation type, each type shall be classified and assessed separately.

NOTES:

- 1 Classification of vegetation should not be based solely on the edge of the vegetation, which may be invaded by weeds or by recent fire activity alone.
- 2 See Figures 2.4(A) to 2.4 (H) which show indicative heights.

C2.2.3.1 *In assessing vegetation, care should be exercised to ensure that a sufficient level of distance is used to determine predominant vegetation. This may necessitate the consideration of vegetation out to distances in excess of 100 metres from the site.*

Vegetation classes may appear to be modified as a result of previous uses, clearing, weed invasion or due to disturbance factors such as fire which may affect short term fire behaviour. The expansion of additional vegetation classes would make implementation of this Standard more difficult. The presence of disturbance by bushfire or past use does not of itself warrant any reduction in the classification of the vegetation. The potential for re-vegetation should be considered.

2.2.3.2 Exclusions—Low threat vegetation and non-vegetated areas

The following vegetation shall be excluded from a BAL assessment:

- (a) Vegetation of any type that is more than 100 m from the site.
- (b) Single areas of vegetation less than 1 ha in area and not within 100 m of other areas of vegetation being classified vegetation.
- (c) Multiple areas of vegetation less than 0.25 ha in area and not within 20 m of the site, or each other or of other areas of vegetation being classified vegetation.
- (d) Strips of vegetation less than 20 m in width (measured perpendicular to the elevation exposed to the strip of vegetation) regardless of length and not within 20 m of the site or each other, or other areas of vegetation being classified vegetation.
- (e) Non-vegetated areas, that is, areas permanently cleared of vegetation, including waterways, exposed beaches, roads, footpaths, buildings and rocky outcrops.
- (f) Vegetation regarded as low threat due to factors such as flammability, moisture content or fuel load. This includes grassland managed in a minimal fuel condition, mangroves and other saline wetlands, maintained lawns, golf courses (such as playing areas and fairways), maintained public reserves and parklands, sporting fields, vineyards, orchards, banana plantations, market gardens (and other non-curing crops), cultivated gardens, commercial nurseries, nature strips and windbreaks.

NOTES:

- 1 Minimal fuel condition means there is insufficient fuel available to significantly increase the severity of the bushfire attack (recognizable as short-cropped grass for example, to a nominal height of 100 mm).
- 2 A windbreak is considered a single row of trees used as a screen or to reduce the effect of wind on the leeward side of the trees.

2.2.4 Step 3—Distance of the site from classified vegetation

For each vegetation type classified in Clause 2.2.3, the distance of the site from the classified vegetation shall be determined, measured in the horizontal plane (see Figure 2.1 Point A to Point B).

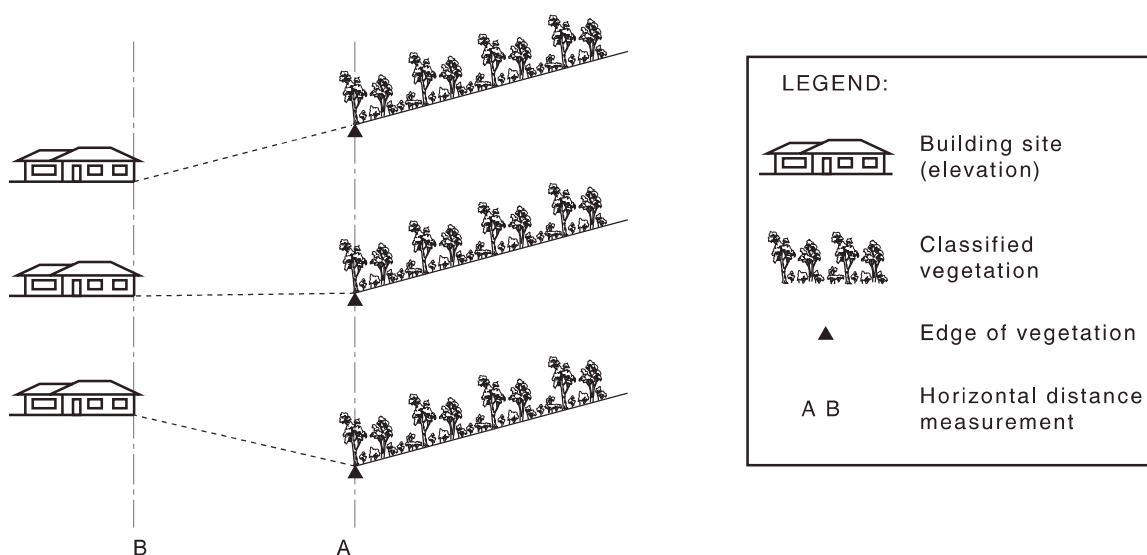

FIGURE 2.1 DETERMINATION OF DISTANCE OF SITE FROM CLASSIFIED VEGETATION

NOTES TO FIGURE 2.1:

1 The measurement of distance A to B is measured in plan (i.e. horizontally) and is taken to the nearest part of an external wall of the proposed building (or the site in the absence of a detailed building design) from the unmanaged vegetation. For those parts of the building that do not have external walls (including carports, verandas, decks, landings, steps and ramps), the distance is measured to the supporting posts or columns. The following parts of the building are excluded when determining the distance A to B:

- (a) Eaves and roof overhangs.
- (b) Rainwater and domestic fuel tanks.
- (c) Chimneys, pipes, cooling or heating appliances or other services.
- (d) Unroofed pergolas.
- (e) Sun blinds.

2 In the three illustrations above, the distance A to B is the same horizontal distance from the classified vegetation to the site. The area between A and B may contain vegetation not required to be classified in accordance with Clause 2.2.3.

2.2.5 Step 4—Effective slope of land under the classified vegetation

‘Slope’ refers to the slope under the classified vegetation in relation to the building—not the slope between the vegetation and the building.

For each vegetation type classified in Clause 2.2.3, the effective slope of the land under the classified vegetation shall be determined in degrees, along with whether it is upslope or downslope in relation to the site (see Figure 2.3). Where there is more than one slope within the classified vegetation, each slope shall be individually assessed and the worst case Bushfire Attack Level shall apply.

Effective slope of land under classified vegetation is presented in degrees within Tables 2.4 to 2.7. As fires travel slower down a hill, all classified vegetation that is upslope will assume a value of 0° (i.e. flat land). Table 2.2 provides comparisons between degrees, slope ratios and percentages.

C2.2.5 *The slope of the land under the classified vegetation is much more important than the slope of the land between the site and the edge of the classified vegetation. The slope of the land under the classified vegetation has a direct influence on the rate of fire spread, the severity of the fire and the ultimate level of radiant heat flux.*

For Method 1 it is not important to determine the slope of the land between the site and the edge of the classified vegetation (see Figure 2.1, Point B to Point A). The further the distance, the less radiant heat reaches the site.

It may be necessary to consider the slope under the classified vegetation for distances greater than 100 m in order to determine the effective slope for that vegetation classification.

Where the slope of the land under the classified vegetation is downhill from the edge of the classified vegetation nearest the site, it is considered ‘downslope’ regardless of the slope of the land between the site and the edge of the classified vegetation [see Figure 2.3].

Where the slope of the land under the classified vegetation is uphill from the edge of the classified vegetation nearest the site, it is considered ‘upslope’ regardless of the slope of the land between the site and the edge of the classified vegetation [see Figure 2.3].

Where the slope varies but falls within the range given in Tables 2.4 to 2.8, there is no need to take separate assessments. Where the slopes vary over two or more slope ranges, then each slope range has to be assessed separately, in conjunction with the relevant vegetation classification. See Figure 2.2 below for example of varying slope ranges to be assessed.

In assessing vegetation classes for forests, woodlands and rainforests, the classified vegetation will be determined by the unmanaged understorey rather than either the canopy (drip line) or the trunk of any trees.

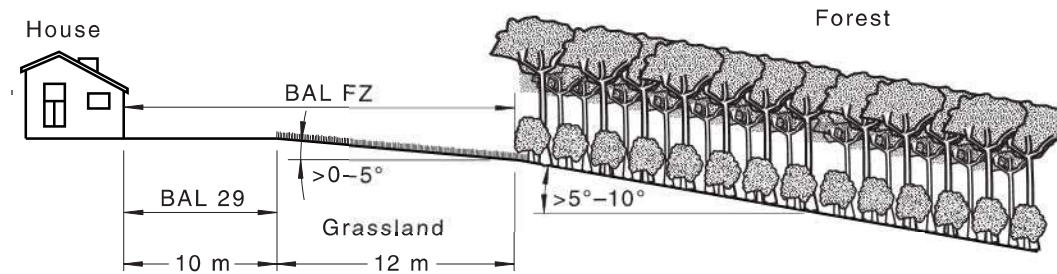
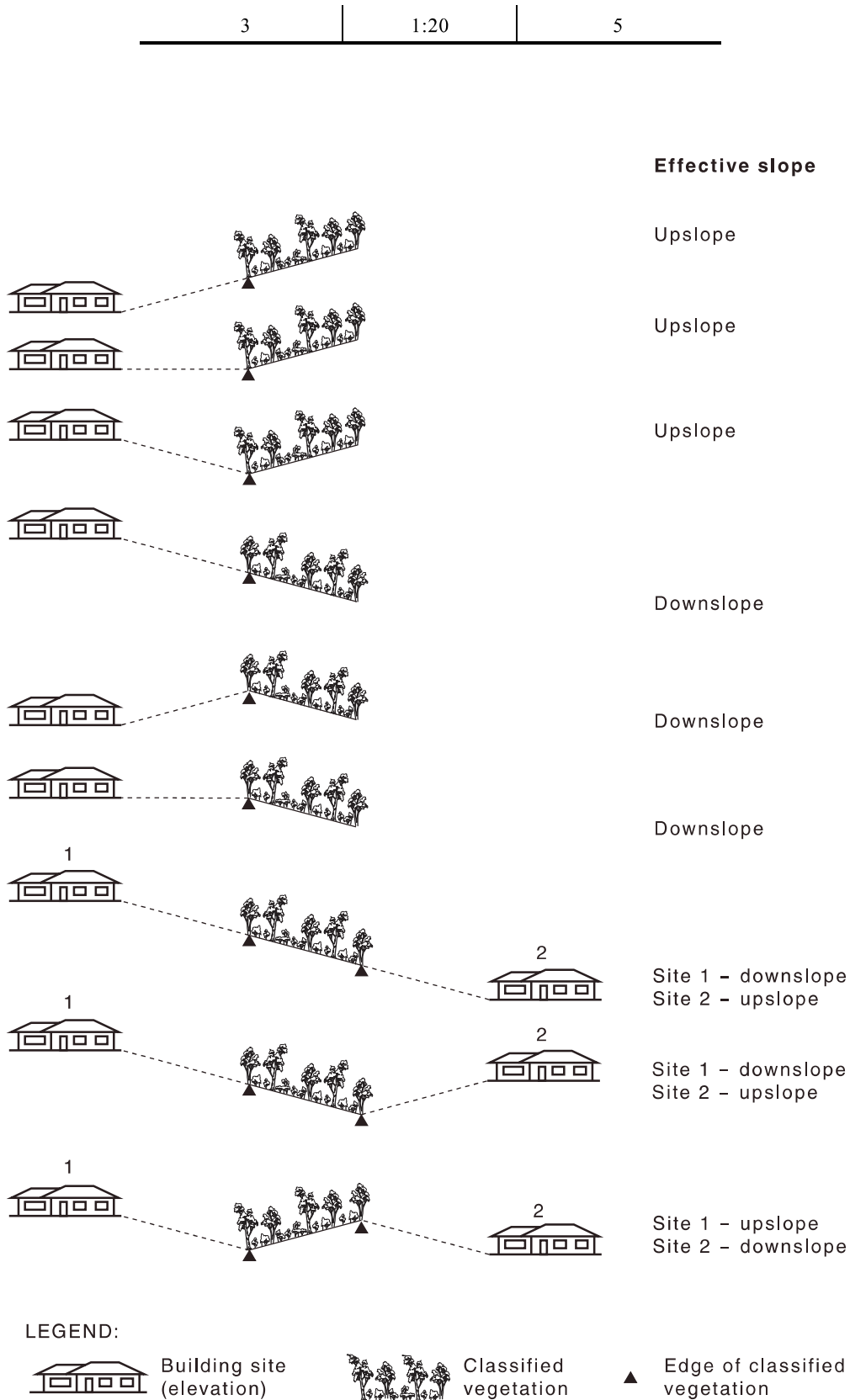

FIGURE 2.2 EXAMPLE OF VARYING SLOPE RANGES FOR ASSESSMENT

**TABLE 2.2
SLOPE COMPARISONS**

Degrees	Ratio	Percentages
45	1:1	100
34	1:1.5	66
26	1:2	50
21	1:2.5	40
18	1:3	33
15	1:3.5	28
14	1:4	25
12	1:4.5	22
11	1:5	20
10	1:5.5	18
9	1:6	16
9	1:6.5	15
8	1:7	14
8	1:7.5	13
7	1:8	12
7	1:8.5	11
6	1:9	11
6	1:10	10
5	1:11	9
5	1:12	8
4	1:13	8
4	1:14	7
4	1:15	7
4	1:16	6
3	1:17	6
3	1:18	5.5
3	1:19	5



NOTE: Effective 'slope' refers to the slope under the classified vegetation in relation to the building—not the slope between the classified vegetation and the building. The slope is determined on the basis of the fire moving towards the building and the rate of spread of the fire and not on the basis of the relative elevation of vegetation alone.

FIGURE 2.3 DETERMINATION OF EFFECTIVE UPSLOPE AND DOWNSLOPE

2.2.6 Step 5—Determination of Bushfire Attack Level (BAL)

The BAL shall be determined in accordance with the following:

- (a) Select the relevant FDI table from Tables 2.4 to 2.8 as determined at Clause 2.2.2 (Step 1).
- (b) Using the relevant FDI table, determine the BAL for each of the vegetation classifications determined at Clause 2.2.3 (Step 2), the distance from the site determined at Clause 2.2.4 (Step 3) and the effective slope determined at Clause 2.2.5 (Step 4).
- (c) Select the highest BAL obtained from Item (b) above.
- (d) The assessed highest BAL applies to the entire building.
- (e) Any adjacent structures that are within 6 metres of the building shall be assessed separately (see Clause 3.2.3).

NOTES:

- 1 The determinations in Tables 2.4 to 2.8 are based on input values contained in Table B1, Appendix B.
- 2 A worked example of determining the BAL is shown in Appendix A.

2.2.7 Step 6—Determination of the appropriate construction requirements

Proceed to Section 3 to determine the appropriate construction requirements.

TABLE 2.3
CLASSIFICATION OF VEGETATION

A2	Vegetation classification	Vegetation type	Figure No. in Figures 2.4(A) to 2.4(H)	Typical characteristics
A2	A Forest	Tall open forest	01	Trees over 30 m high; 30%–70% foliage cover (may include understorey ranging from rainforest species and tree ferns to low trees and tall shrubs). Found in areas of high reliable rainfall. Typically dominated by eucalypts with a sub-dominant tree layer.
		Tall woodland	02	
A2		Open forest	03	Trees up to 30 m high; 30%–70% foliage cover (may include understorey of sclerophyllous low trees or shrubs). Typically dominated by eucalypts, melaleuca or callistemon (may include riverine and wetland environments) and callitris. Includes eucalypt plantations.
		Low open forest	04	
		Pine plantation	Not shown	Trees 30 m in height at maturity, generally comprising <i>Pinus</i> species or other softwood species, planted as a single species for the production of timber.
A2	B Woodland	Woodland	05	Trees up to 30 m high; 10%–30% foliage cover dominated by eucalypts and/or callitris with a prominent grassy understorey. May contain isolated shrubs.
		Low woodland	07	
A2	C Shrubland	Closed (low) heath	10	Found in wet areas and/or areas affected by poor soil fertility or shallow soils. Shrubs 1 m–2 m high. Wet heaths occur in sands adjoining dunes of the littoral (shore) zone. Montane heaths occur on shallow or water-logged soils.
		Open heath	11	
		Low shrubland	12	Shrubs <2 m high; greater than 30% foliage cover. Understoreys may contain grasses. Acacia and Casuarina often dominant in the arid and semi-arid zones.
A2	D Scrub	Closed scrub (Tall heaths)	13	Found in wet areas and/or areas affected by poor soil fertility or shallow soils; >30% foliage cover. Dry heaths occur in rocky or sandy areas. Shrubs >2 m high. Typical of coastal areas and tall heaths up to 6 metres in height. May be dominated by <i>Banksia</i> , <i>Melaleuca</i> or <i>Leptospermum</i> with heights of up to 6 metres.
		Open scrub	14	Shrubs greater than 2 m high; 10%–30% foliage cover with a mixed species composition.
	E Mallee/Mulga	Tall shrubland	15	Vegetation dominated by low trees or tall shrubs (especially eucalypts and acacias) some with a multi-stemmed habit (mallee); usually greater than 2 m in height; <30% foliage cover. Understorey of widespread dense low shrubs or sparse grasses and generally found in the arid and semi-arid zones, but not within the rangelands.
	F Rainforest	Tall closed forest	16	Trees >90% foliage cover; understorey may contain a large number of species with a variety of heights. Not dominated by eucalypt species.
		Closed forest	17	
		Low closed forest	18	

(continued)

TABLE 2.3 (continued)

A2

Vegetation classification	Vegetation type	Figure No. in Figures 2.4(A) to 2.4(H)	Typical characteristics
G Grassland	Open woodland	06	All forms (except tussock moorlands), including situations with shrubs and trees, if the overstorey foliage cover is less than 10%. Includes pasture and cropland. NOTE: Grassland managed in a minimal fuel condition and non-curing cropland is regarded as low threat vegetation for the purposes of Clause 2.2.3.2.
	Low open woodland	08	
	Open shrubland	09	
	Low open shrubland	19	
	Hummock grassland	20	
	Closed tussock grassland	21	
	Tussock grassland	22	
	Open tussock	23	
	Sparse open tussock	24	
	Dense sown pasture	25	
	Sown pasture	26	
	Open herbfield	27	
Sparse open herbfield	28		
H Tussock Moorland	Tussock Moorland	Not shown	All forms of vegetation where the overstorey is dominated by the species Buttongrass (<i>Gymnoschoenus sphaerocephalus</i>). Only occurs as a significant vegetation type in Tasmania.

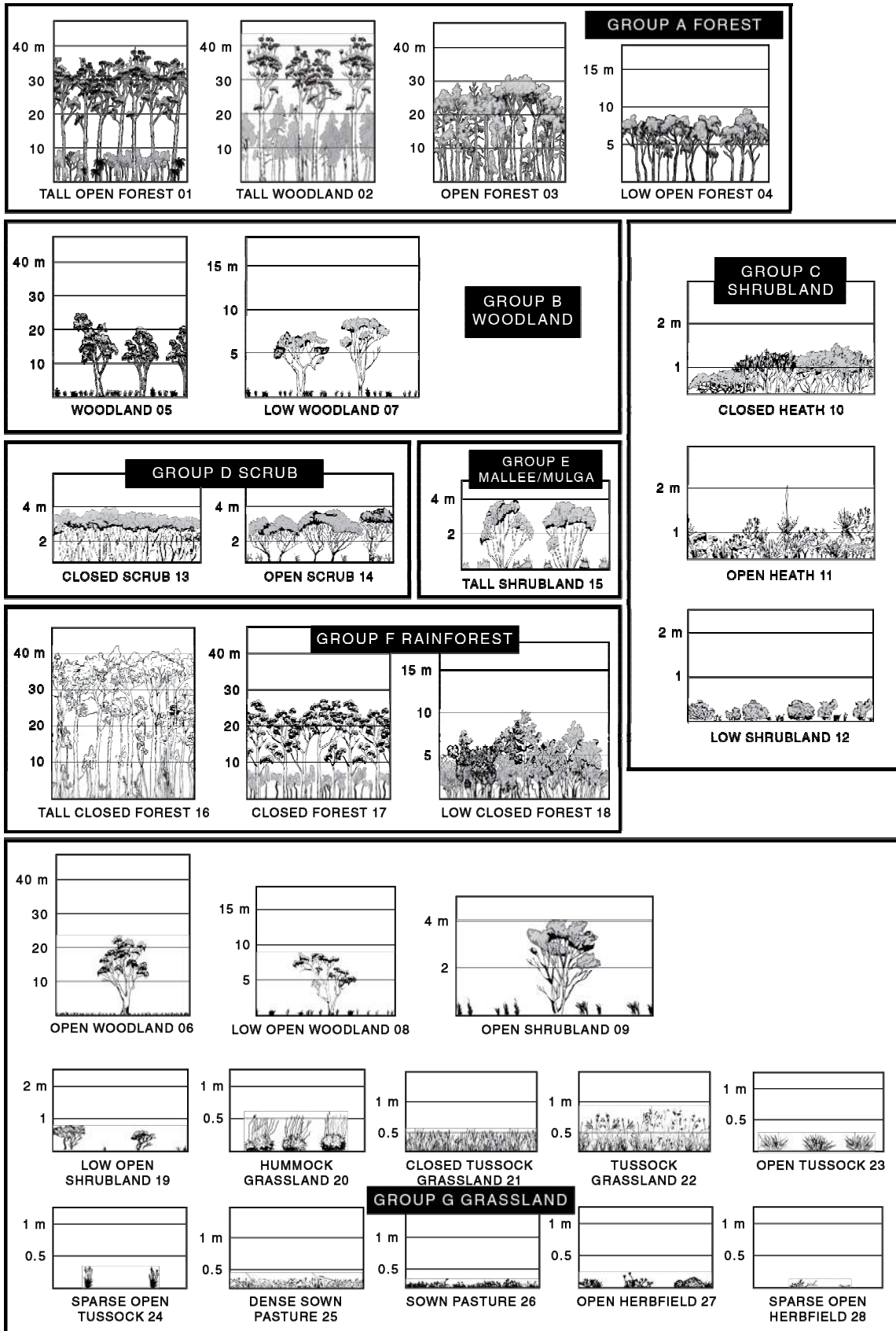

NOTE: See Figures 2.4(B) to 2.4(H) for greater vegetation detail.

FIGURE 2.4(A) CLASSIFICATION OF VEGETATION—SUMMARY

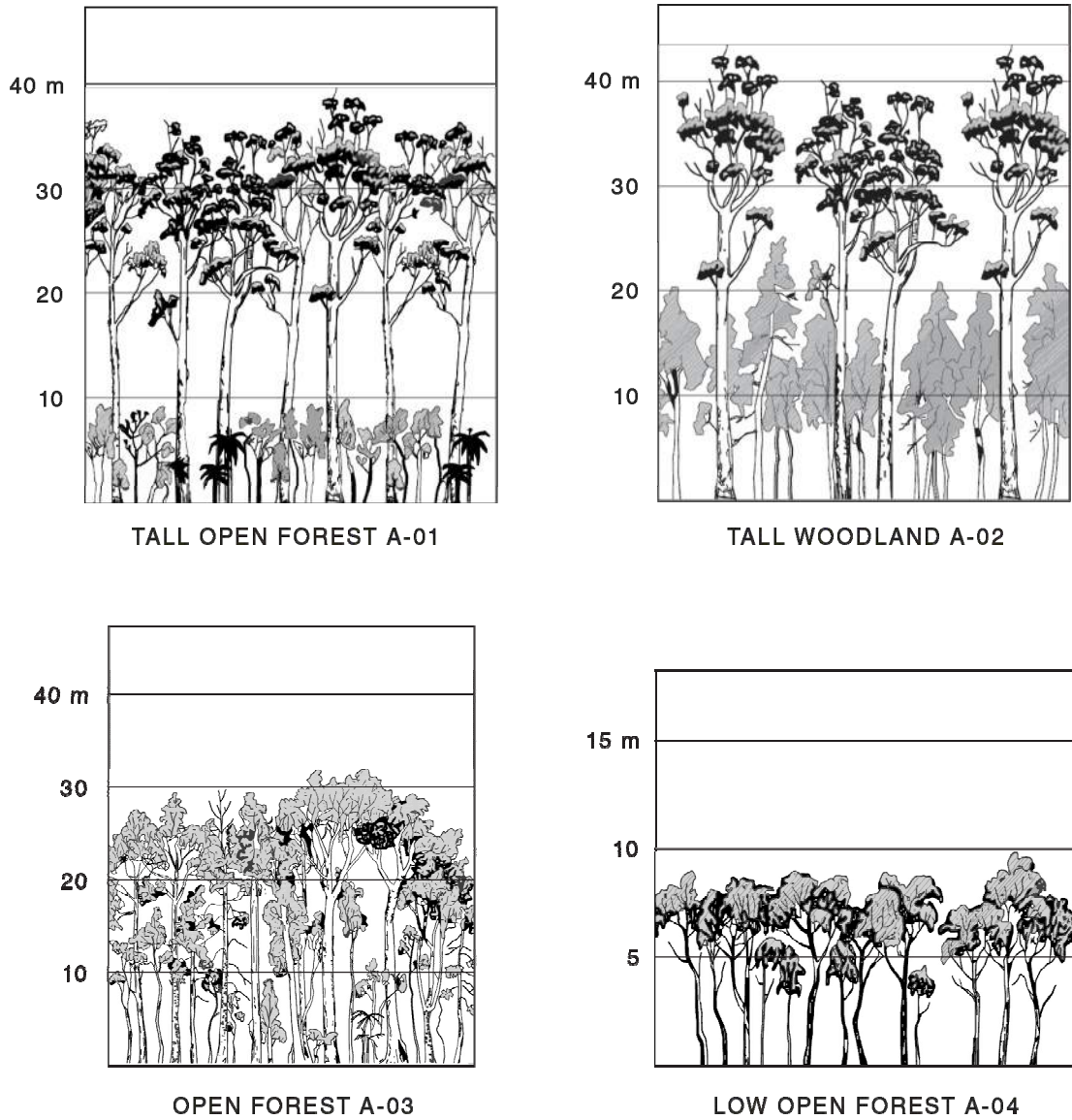

NOTE: See Table 2.3.

FIGURE 2.4(B) CLASSIFICATION OF VEGETATION—FOREST

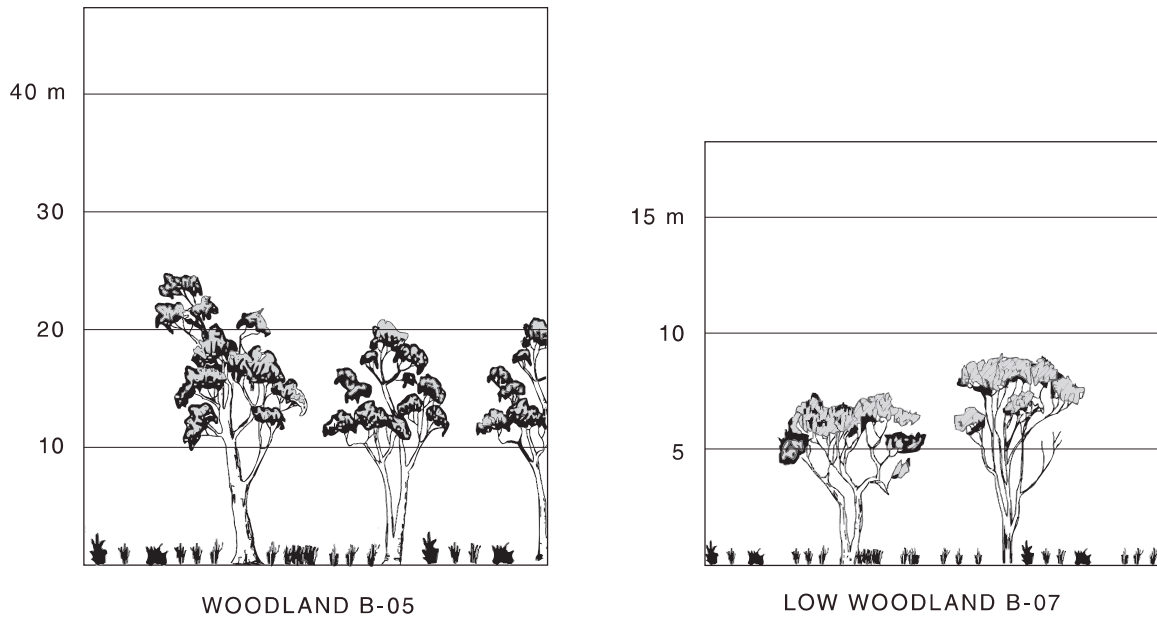

NOTE: See Table 2.3.

FIGURE 2.4(C) CLASSIFICATION OF VEGETATION—WOODLAND

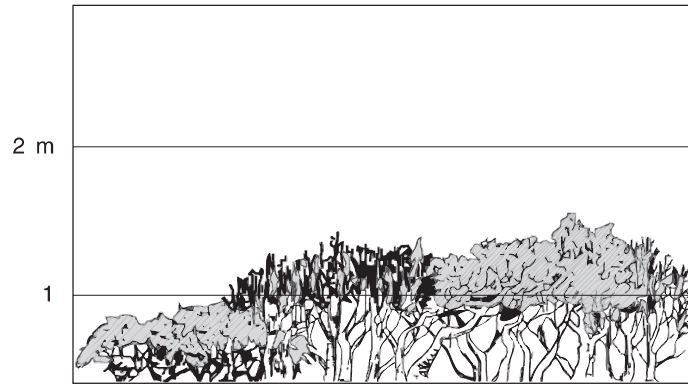

CLOSED HEATH C-10



OPEN HEATH C-11

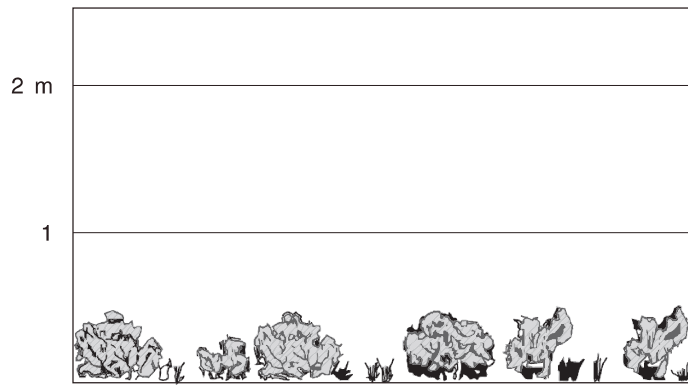

LOW SHRUBLAND C-12

NOTE: See Table 2.3.

FIGURE 2.4(D) CLASSIFICATION OF VEGETATION—SHRUBLAND

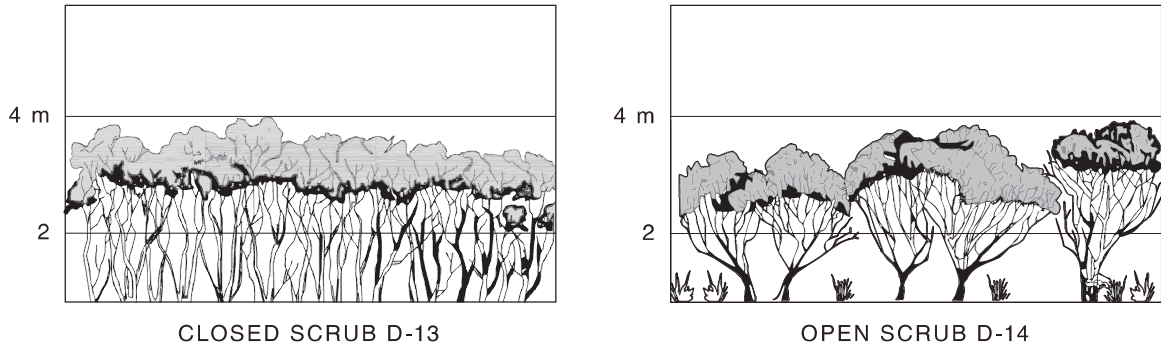

NOTE: See Table 2.3.

FIGURE 2.4(E) CLASSIFICATION OF VEGETATION—SCRUB (TALL HEATH)

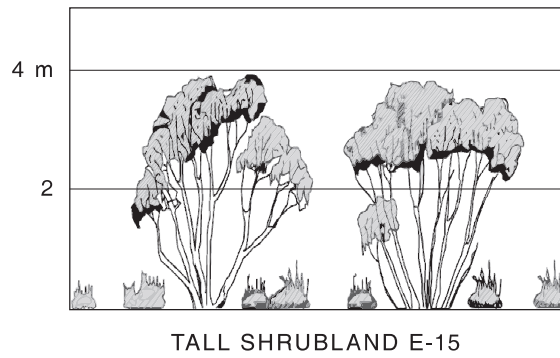

NOTE: See Table 2.3.

FIGURE 2.4(F) CLASSIFICATION OF VEGETATION—MALLEE/MULGA

Copyrighted material licensed to TASTAFE by Techstreet LLC, subscriptions.techstreet.com, downloaded on 2023-12-20 05:16:31 +0000 by TASTAFE User. No further reproduction or distribution is permitted.

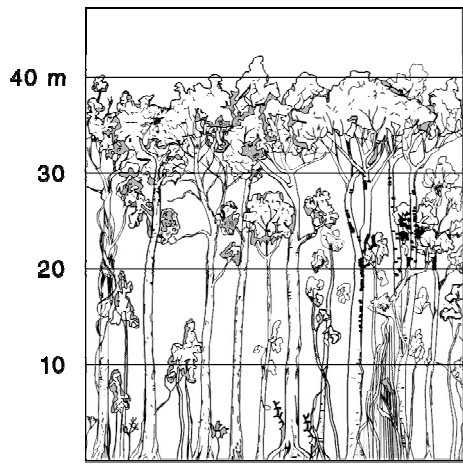

TALL CLOSED FOREST F-16

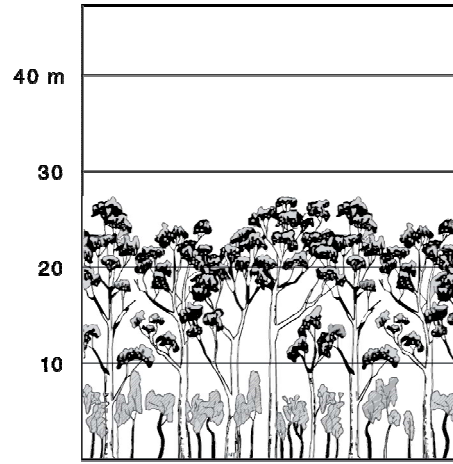

CLOSED FOREST F-17

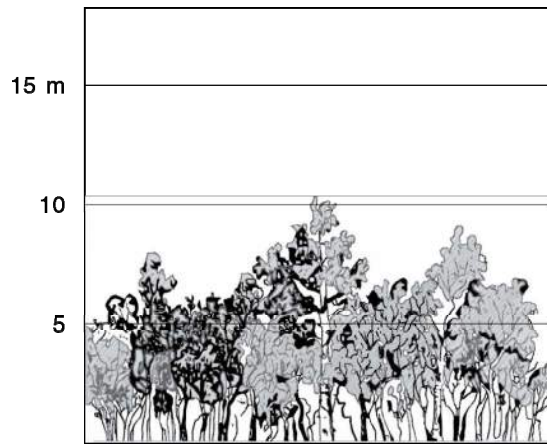

LOW CLOSED FOREST F-18

NOTE: See Table 2.3.

FIGURE 2.4(G) CLASSIFICATION OF VEGETATION—RAINFOREST

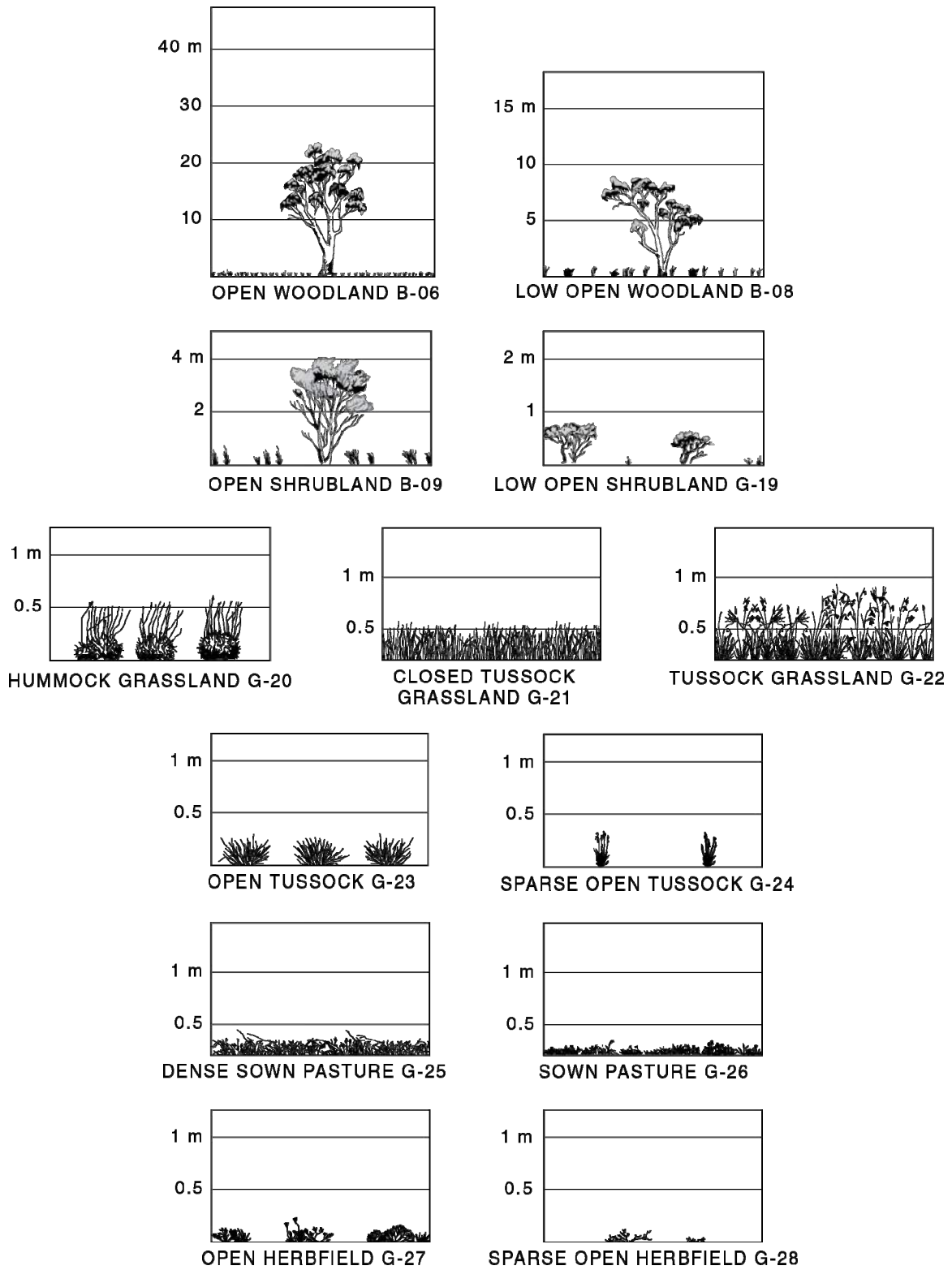

NOTE: See Table 2.3.

FIGURE 2.4(H) CLASSIFICATION OF VEGETATION—GRASSLAND (UNMANAGED)

TABLE 2.4
DETERMINATION OF BUSHFIRE ATTACK LEVEL (BAL)—FDI 100 (1090 K)

Vegetation classification	BALs				
	BAL—FZ	BAL—40	BAL—29	BAL—19	BAL—12.5
	Distance (m) of the site from the predominant vegetation class				
	All upslopes and flat land (0 degrees)				
A. Forest	<19	19–<25	25–<35	35–<48	48–<100
B. Woodland	<12	12–<16	16–<24	24–<33	33–<100
C. Shrubland	<7	7–<9	9–<13	13–<19	19–<100
D. Scrub	<10	10–<13	13–<19	19–<27	27–<100
E. Mallee/Mulga	<6	6–<8	8–<12	12–<17	17–<100
F. Rainforest	<8	8–<11	11–<16	16–<23	23–<100
G. Grassland	<6	6–<9	9–<13	13–<19	19–50
Downslope >0 to 5 degrees					
A. Forest	<24	24–<32	32–<43	43–<57	57–<100
B. Woodland	<15	15–<21	21–<29	29–<41	41–<100
C. Shrubland	<7	7–<10	10–<15	15–<22	22–<100
D. Scrub	<11	11–<15	15–<22	22–<31	31–<100
E. Mallee/Mulga	<7	7–<9	9–<13	13–<20	20–<100
F. Rainforest	<10	10–<14	14–<20	20–<29	29–<100
G. Grassland	<7	7–<10	10–<15	15–<22	22–<50
Downslope >5 to 10 degrees					
A. Forest	<31	31–<39	39–<53	53–<69	69–<100
B. Woodland	<20	20–<26	26–<37	37–<50	50–<100
C. Shrubland	<8	8–<11	11–<17	17–<25	25–<100
D. Scrub	<12	12–<17	17–<24	24–<35	35–<100
E. Mallee/Mulga	<7	7–<10	10–<15	15–<23	23–<100
F. Rainforest	<13	13–<18	18–<26	26–<36	36–<100
G. Grassland	<8	8–<11	11–<17	17–<25	25–<50
Downslope >10 to 15 degrees					
A. Forest	<39	39–<49	49–<64	64–<82	82–<100
B. Woodland	<25	25–<33	33–<45	45–<60	60–<100
C. Shrubland	<9	9–<13	13–<19	19–<28	28–<100
D. Scrub	<14	14–<19	19–<28	28–<39	39–<100
E. Mallee/Mulga	<8	8–<11	11–<18	18–<26	26–<100
F. Rainforest	<17	17–<23	23–<33	33–<45	45–<100
G. Grassland	<9	9–<13	13–<20	20–<28	28–<50
Downslope >15 to 20 degrees					
A. Forest	<50	50–<61	61–<78	78–<98	98–<100
B. Woodland	<32	32–<41	41–<56	56–<73	73–<100
C. Shrubland	<10	10–<15	15–<22	22–<31	31–<100
D. Scrub	<15	15–<21	21–<31	31–<43	43–<100
E. Mallee/Mulga	<9	9–<13	13–<20	20–<29	29–<100
F. Rainforest	<22	22–<29	29–<42	42–<56	56–<100
G. Grassland	<11	11–<15	15–<23	23–<32	32–<50

TABLE 2.5
DETERMINATION OF BUSHFIRE ATTACK LEVEL (BAL)—FDI 80 (1090 K)

Vegetation classification	BALs				
	BAL—FZ	BAL—40	BAL—29	BAL—19	BAL—12.5
	Distance (m) of the site from the predominant vegetation class				
	All upslopes and flat land (0 degrees)				
A. Forest	<16	16—<21	21—<31	31—<42	42—<100
B. Woodland	<10	10—<14	14—<20	20—<29	29—<100
C. Shrubland	<7	7—<9	9—<13	13—<19	19—<100
D. Scrub	<10	10—<13	13—<19	19—<27	27—<100
E. Mallee/Mulga	<6	6—<8	8—<12	12—<17	17—<100
F. Rainforest	<6	6—<9	9—<13	13—<19	19—<100
G. Grassland	<6	6—<8	8—<12	12—<17	17—<50
	Downslope >0 to 5 degrees				
A. Forest	<20	20—<27	27—<37	37—<50	50—<100
B. Woodland	<13	13—<17	17—<25	25—<35	35—<100
C. Shrubland	<7	7—<10	10—<15	15—<22	22—<100
D. Scrub	<11	11—<15	15—<22	22—<31	31—<100
E. Mallee/Mulga	<7	7—<9	9—<13	13—<20	20—<100
F. Rainforest	<8	8—<11	11—<17	17—<24	24—<100
G. Grassland	<7	7—<9	9—<14	14—<20	20—<50
	Downslope >5 to 10 degrees				
A. Forest	<26	26—<33	33—<46	46—<61	61—<100
B. Woodland	<16	16—<22	22—<31	31—<43	43—<100
C. Shrubland	<8	8—<11	11—<17	17—<25	25—<100
D. Scrub	<12	12—<17	17—<24	24—<35	35—<100
E. Mallee/Mulga	<7	7—<10	10—<15	15—<23	23—<100
F. Rainforest	<11	11—<15	15—<22	22—<31	31—<100
G. Grassland	<8	8—<10	10—<16	16—<23	23—<50
	Downslope >10 to 15 degrees				
A. Forest	<33	33—<42	42—<56	56—<73	73—<100
B. Woodland	<21	21—<28	28—<39	39—<53	53—<100
C. Shrubland	<9	9—<13	13—<19	19—<28	28—<100
D. Scrub	<14	14—<19	19—<28	28—<39	39—<100
E. Mallee/Mulga	<8	8—<11	11—<18	18—<26	26—<100
F. Rainforest	<14	14—<19	19—<28	28—<39	39—<100
G. Grassland	<9	9—<12	12—<18	18—<26	26—<50
	Downslope >15 to 20 degrees				
A. Forest	<42	42—<52	52—<68	68—<87	87—<100
B. Woodland	<27	27—<35	35—<48	48—<64	64—<100
C. Shrubland	<10	10—<15	15—<22	22—<31	31—<100
D. Scrub	<15	15—<21	21—<31	31—<43	43—<100
E. Mallee/Mulga	<9	9—<13	13—<20	20—<29	29—<100
F. Rainforest	<18	18—<25	25—<36	36—<48	48—<100
G. Grassland	<10	10—<14	14—<21	21—<30	30—<50

TABLE 2.6
DETERMINATION OF BUSHFIRE ATTACK LEVEL (BAL)—FDI 50 (1090 K)

Vegetation classification	BALs				
	BAL—FZ	BAL—40	BAL—29	BAL—19	BAL—12.5
	Distance (m) of the site from the predominant vegetation class				
	All upslopes and flat land (0 degrees)				
A. Forest	<12	12—<16	16—<23	23—<32	32—<100
B. Woodland	<7	7—<10	10—<15	15—<22	22—<100
C. Shrubland	<7	7—<9	9—<13	13—<19	19—<100
D. Scrub	<10	10—<13	13—<19	19—<27	27—<100
E. Mallee/Mulga	<6	6—<8	8—<12	12—<17	17—<100
F. Rainforest	<5	5—<6	6—<9	9—<14	14—<100
G. Grassland	<5	5—<6	6—<10	10—<14	14—<50
H. Tussock moorland	<7	7—<9	9—<14	14—<20	20—<100
	Downslope >0 to 5 degrees				
A. Forest	<14	14—<19	19—<27	27—<38	38—<100
B. Woodland	<9	9—<12	12—<18	18—<26	26—<100
C. Shrubland	<7	7—<10	10—<15	15—<22	22—<100
D. Scrub	<11	11—<15	15—<22	22—<31	31—<100
E. Mallee/Mulga	<7	7—<9	9—<13	13—<20	20—<100
F. Rainforest	<6	6—<8	8—<12	12—<17	17—<100
G. Grassland	<5	5—<7	7—<11	11—<16	16—<50
H. Tussock moorland	<8	8—<10	10—<16	16—<23	23—<100
	Downslope >5 to 10 degrees				
A. Forest	<18	18—<24	24—<34	34—<46	46—<100
B. Woodland	<11	11—<15	15—<23	23—<32	32—<100
C. Shrubland	<8	8—<11	11—<17	17—<25	25—<100
D. Scrub	<12	12—<17	17—<24	24—<35	35—<100
E. Mallee/Mulga	<7	7—<10	10—<15	15—<23	23—<100
F. Rainforest	<7	7—<10	10—<15	15—<22	22—<100
G. Grassland	<6	6—<8	8—<13	13—<19	19—<50
H. Tussock moorland	<9	9—<12	12—<18	18—<26	26—<100
	Downslope >10 to 15 degrees				
A. Forest	<22	22—<30	30—<41	41—<56	56—<100
B. Woodland	<14	14—<19	19—<28	28—<40	40—<100
C. Shrubland	<9	9—<13	13—<19	19—<28	28—<100
D. Scrub	<14	14—<19	19—<28	28—<39	39—<100
E. Mallee/Mulga	<8	8—<11	11—<18	18—<26	26—<100
F. Rainforest	<9	9—<13	13—<19	19—<28	28—<100
G. Grassland	<7	7—<10	10—<15	15—<22	22—<50
H. Tussock moorland	<10	10—<13	13—<20	20—<29	29—<100
	Downslope >15 to 20 degrees				
A. Forest	<28	28—<37	37—<51	51—<67	67—<100
B. Woodland	<18	18—<25	25—<36	36—<48	48—<100
C. Shrubland	<10	10—<15	15—<22	22—<31	31—<100
D. Scrub	<15	15—<21	21—<31	31—<43	43—<100
E. Mallee/Mulga	<9	9—<13	13—<20	20—<29	29—<100
F. Rainforest	<12	12—<17	17—<25	25—<35	35—<100
G. Grassland	<8	8—<11	11—<17	17—<25	25—<50
H. Tussock moorland	<11	11—<15	15—<23	23—<33	33—<100

TABLE 2.7
DETERMINATION OF BUSHFIRE ATTACK LEVEL (BAL)—FDI 40 (1090 K)

Vegetation classification	BALs				
	BAL—FZ	BAL—40	BAL—29	BAL—19	BAL—12.5
	Distance (m) of the site from the predominant vegetation class				
	All upslopes and flat land (0 degrees)				
A. Forest	<10	10–<13	13–<20	20–<28	28–<100
B. Woodland	<6	6–<9	9–<13	13–<19	19–<100
C. Shrubland	<7	7–<9	9–<13	13–<19	19–<100
D. Scrub	<10	10–<13	13–<19	19–<27	27–<100
E. Mallee/Mulga	<6	6–<8	8–<12	12–<17	17–<100
F. Rainforest	<4	4–<5	5–<8	8–<12	12–<100
G. Grassland	<4	4–<5	5–<8	8–<12	12–<50
	Downslope >0 to 5 degrees				
A. Forest	<12	12–<16	16–<24	24–<34	34–<100
B. Woodland	<8	8–<11	11–<16	16–<23	23–<100
C. Shrubland	<7	7–<10	10–<15	15–<22	22–<100
D. Scrub	<11	11–<15	15–<22	22–<31	31–<100
E. Mallee/Mulga	<7	7–<9	9–<13	13–<20	20–<100
F. Rainforest	<5	5–<7	7–<10	10–<15	15–<100
G. Grassland	<4	4–<6	6–<9	9–<14	14–<50
	Downslope >5 to 10 degrees				
A. Forest	<15	15–<20	20–<29	29–<41	41–<100
B. Woodland	<9	9–<13	13–<19	19–<28	28–<100
C. Shrubland	<8	8–<11	11–<17	17–<25	25–<100
D. Scrub	<12	12–<17	17–<24	24–<35	35–<100
E. Mallee/Mulga	<7	7–<10	10–<15	15–<23	23–<100
F. Rainforest	<6	6–<8	8–<13	13–<19	19–<100
G. Grassland	<5	5–<7	7–<11	11–<16	16–<50
	Downslope >10 to 15 degrees				
A. Forest	<19	19–<25	25–<36	36–<49	49–<100
B. Woodland	<12	12–<16	16–<24	24–<35	35–<100
C. Shrubland	<9	9–<13	13–<19	19–<28	28–<100
D. Scrub	<14	14–<19	19–<28	28–<39	39–<100
E. Mallee/Mulga	<8	8–<11	11–<18	18–<26	26–<100
F. Rainforest	<8	8–<11	11–<16	16–<24	24–<100
G. Grassland	6	6–<8	8–<13	13–<19	19–<50
	Downslope >15 to 20 degrees				
A. Forest	<24	24–<31	31–<44	44–<59	59–<100
B. Woodland	<15	15–<21	21–<31	31–<42	42–<100
C. Shrubland	<10	10–<15	15–<22	22–<31	31–<100
D. Scrub	<15	15–<21	21–<31	31–<43	43–<100
E. Mallee/Mulga	<9	9–<13	13–<20	20–<29	29–<100
F. Rainforest	<10	10–<14	14–<21	21–<30	30–<100
G. Grassland	<7	7–<9	9–<15	15–<22	22–<50

SECTION 3 GENERAL CONSTRUCTION REQUIREMENTS

3.1 GENERAL

This Section specifies general requirements for the construction of buildings for all Bushfire Attack Levels (BALs).

The BALs and the corresponding Sections for specific construction requirements are listed in Table 3.1.

TABLE 3.1
BUSHFIRE ATTACK LEVELS AND CORRESPONDING SECTIONS FOR SPECIFIC CONSTRUCTION REQUIREMENTS

Bushfire Attack Level (BAL)	Classified vegetation within 100 m of the site and heat flux exposure thresholds	Description of predicted bushfire attack and levels of exposure	Construction Section
BAL—LOW	See Clause 2.2.3.2	There is insufficient risk to warrant specific construction requirements	4
BAL—12.5	$\leq 12.5 \text{ kW/m}^2$	Ember attack	3 and 5
BAL—19	$> 12.5 \text{ kW/m}^2$ $\leq 19 \text{ kW/m}^2$	Increasing levels of ember attack and burning debris ignited by windborne embers together with increasing heat flux	3 and 6
BAL—29	$> 19 \text{ kW/m}^2$ $\leq 29 \text{ kW/m}^2$	Increasing levels of ember attack and burning debris ignited by windborne embers together with increasing heat flux	3 and 7
BAL—40	$> 29 \text{ kW/m}^2$ $\leq 40 \text{ kW/m}^2$	Increasing levels of ember attack and burning debris ignited by windborne embers together with increasing heat flux with the increased likelihood of direct contact with flames	3 and 8
BAL—FZ	$> 40 \text{ kW/m}^2$	Direct exposure to flames from fire front in addition to heat flux and ember attack	3 and 9

3.2 CONSTRUCTION REQUIREMENTS FOR SPECIFIC STRUCTURES

3.2.1 Attached structures and structures sharing a common roof space

Where any part of a garage, carport, veranda, cabana, studio, storage area or similar roofed structure is attached to, or shares a common roof space with, a building required to conform with this Standard, the entire garage, carport, veranda or similar roofed structure shall conform with the construction requirements of this Standard, as applicable to the subject building.

Alternatively, the structure shall be separated from the subject building by a wall that extends to the underside of a non-combustible roof covering, and that conforms with one of the following:

- (a) The wall shall have an FRL of not less than 60/60/60 for loadbearing walls and –/60/60 for non-loadbearing walls when tested from the attached structure side and shall have openings protected as follows:
- (i) *Doorways*—by self-closing fire doors with an FRL of –/60/30, that conforms with AS 1905.1 and tested in accordance with AS 1530.4.
 - (ii) *Windows*—by fire windows with an FRL of –/60/– when tested in accordance with AS 1530.4 and permanently fixed in the closed position.

A2

- (iii) *Other openings*—by construction with an FRL of not less than $-/60/-$ when tested in accordance with AS 1530.4.

NOTE: Control and construction joints, subfloor vents, weepholes and penetrations for pipes and conduits need not conform with Item (iii).

or

- (b) The wall shall be of masonry, earth or masonry-veneer construction with the masonry leaf of not less than 90 mm in thickness and shall have openings protected as follows:

A2

- (i) *Doorways*—by self-closing fire doors with an FRL of $-/60/30$, that conforms with AS 1905.1 and tested in accordance with AS 1530.4.
- (ii) *Windows*—by fire windows with an FRL of $-/60/-$ when tested in accordance with AS 1530.4 and permanently fixed in the closed position.
- (iii) *Other openings*—by construction with an FRL of not less than $-/60/-$ when tested in accordance with AS 1530.4.

NOTE: Control and construction joints, subfloor vents, weepholes and penetrations for pipes and conduits need not conform with Item (iii).

3.2.2 Garages and carports beneath the subject building

Where a garage or carport is beneath a building required to comply with this Standard, it shall conform with the construction requirements of this Standard, as applicable to the subject building.

Alternatively, any construction separating the garage or carport (including walls and flooring systems) from the remainder of the building shall conform with one of the following:

- (a) The separating construction shall have an FRL of not less than 60/60/60 for loadbearing construction and $-/60/60$ for non-loadbearing construction when tested from the garage or carport side and shall have openings protected in accordance with the following:

A2

- (i) *Doorways*—by self-closing fire doors with an FRL of $-/60/30$, that conforms with AS 1905.1 and tested in accordance with AS 1530.4.
- (ii) *Windows*—by fire windows with an FRL of $-/60/-$ when tested in accordance with AS 1530.4 and permanently fixed in the closed position.
- (iii) *Other openings*—by construction with an FRL of not less than $-/60/-$ when tested in accordance with AS 1530.4.

NOTE: Control and construction joints, subfloor vents, weepholes and penetrations for pipes and conduits need not conform with Item (iii).

or

- (b) Where part or all of the separating construction is a wall, the wall need not conform with Item (a) above, provided the wall is of masonry, earth or masonry-veneer construction with the masonry leaf of not less than 90 mm in thickness and the wall has openings protected in accordance with the following:

A2

- (i) *Doorways*—by self-closing fire doors with an FRL of $-/60/30$ that conforms with AS 1905.1 and tested in accordance with AS 1530.4.
- (ii) *Windows*—by fire windows with an FRL of $-/60/-$ when tested in accordance with AS 1530.4 and permanently fixed in the closed position.
- (iii) *Other openings*—by construction with an FRL not less than $-/60/-$ when tested in accordance with AS 1530.4.

NOTE: Control and construction joints, subfloor vents, weepholes and penetrations for pipes and conduits need not conform with Item (iii).

3.2.3 Adjacent structures on the subject allotment

Where any garage, carport, or similar roofed structure on the subject allotment is not attached to a building required to conform with this Standard, that structure shall conform with the construction requirements of this Standard.

Alternatively, the adjacent structure shall be separated from the subject building by one of the following:

- (a) A distance of not less than 6 m from the building required to conform with this Standard. This distance is measured as any of the horizontal straight lines from the adjacent structure to the subject building.

or

- (b) A wall of the building required to conform that extends to the underside of a non-combustible roof covering and has an FRL of not less than 60/60/60 for loadbearing walls and –/60/60 for non-loadbearing walls when tested from the outside. Any openings in the wall shall be protected in accordance with the following:

- (i) *Doorways*—by self-closing fire doors with an FRL of –/60/30, that conforms with AS 1905.1 and tested in accordance with AS 1530.4.
- (ii) *Windows*—by fire windows with an FRL of –/60/– when tested in accordance with AS 1530.4 and permanently fixed in the closed position.
- (iii) *Other openings*—by construction with an FRL of not less than –/60/– when tested in accordance with AS 1530.4.

NOTE: Control and construction joints, subfloor vents, weepholes and penetrations for pipes and conduits need not conform with Item (iii).

or

- (c) A wall of the building required to conform that extends to the underside of a non-combustible roof covering and is of masonry, earth or masonry-veneer construction with the masonry leaf of not less than 90 mm in thickness. Any openings in the wall shall be protected in accordance with the following:

- (i) *Doorways*—by self-closing fire doors with an FRL of –/60/30, that conforms with AS 1905.1 and tested in accordance with AS 1530.4.
- (ii) *Windows*—by fire windows with an FRL of –/60/– when tested in accordance with AS 1530.4 and permanently fixed in the closed position.
- (iii) *Other openings*—by construction with an FRL of not less than –/60/– when tested in accordance with AS 1530.4.

NOTE: Control and construction joints, subfloor vents, weepholes and penetrations for pipes and conduits need not conform with Item (iii).

3.3 EXTERNAL MOULDINGS

Unless otherwise required in Clause 3.6.1 and Sections 5 to 9, combustible external mouldings, jointing strips, trims and sealants may be used for decorative purposes or to cover joints between sheeting material.

3.4 HIGHER LEVELS OF CONSTRUCTION

The construction requirements specified for a particular BAL shall be acceptable for a lower level.

NOTE: For example, if the site has been assessed at BAL—12.5, BAL—12.5 construction is required; however any element or combination of elements contained in BAL—19, BAL—29, BAL—40 and BAL—FZ levels of construction may be used to satisfy this Standard.

3.5 REDUCTION IN CONSTRUCTION REQUIREMENTS DUE TO SHIELDING

Where an elevation is not exposed to the source of bushfire attack, then the construction requirements for that elevation can reduce to the next lower BAL. However it shall not reduce to below BAL—12.5.

An elevation is deemed to be not exposed to the source of bushfire attack if all of the straight lines between that elevation and the source of bushfire attack are obstructed by another part of the same building (see Figure 3.1). However it shall not reduce to below BAL 12.5.

The shielding of an elevation shall apply to all the elements of the wall, including openings, but shall not apply to subfloors or roofs.

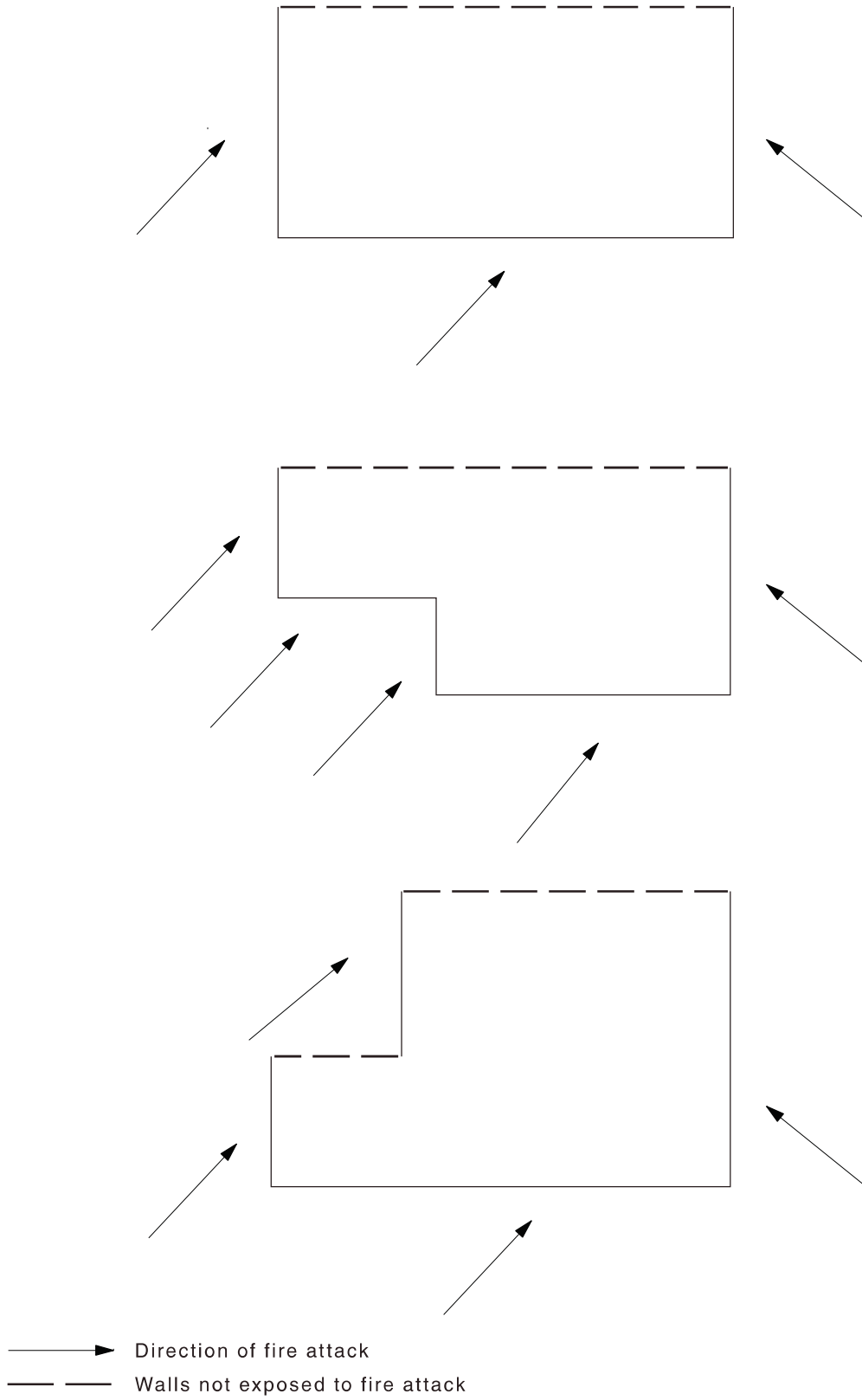

FIGURE 3.1 EXAMPLES OF WALLS SUBJECT TO SHIELDING

A2 | 3.6 VENTS, WEEPHOLES, GAPS AND SCREENING MATERIAL**3.6.1 Vents, weepholes, joints and the like**

All gaps including vents, weepholes and the like shall be screened, except for weepholes to the sills of windows and doors.

All joints shall be suitably backed with a breathable sarking or mesh, except as permitted by Clause 3.3.

The maximum allowable aperture size of any mesh or perforated material used as a screen shall be 2 mm.

C3.6.1 Weepholes in sills of windows and doors and those gaps between doors and door jambs, heads or sills (thresholds) are exempt from screening because they do not provide a direct passage for embers to the interior of the building or building cavity.

3.6.2 Gaps to door and window openings

Where screens are fitted to door openings for ember protection, they shall have a maximum aperture of 2.0 mm and be tight fitting to the frame in the closed position.

Gaps between doors including jambs, heads or sills (thresholds) shall be protected using draught seals and excluders or the like (see Figure 3.2).

Windows conformant with AS 2047 will satisfy the requirements for gap protection. Screens fitted to window openings shall have a maximum aperture of 2.0 mm and these shall be tight fitting to the frames.

A2 | C3.6.2 There is no requirement to screen the openable parts of doors for ember protection at the lower BALs, however in many circumstances it may be desirable to screen the opening for insect protection. In such circumstances, where the insect screen is fitted internally, such screens may be considered as a door furnishing and the use of non-metallic mesh permissible, provided the screening system is fitted internally and wholly protected by the closed door.

A2

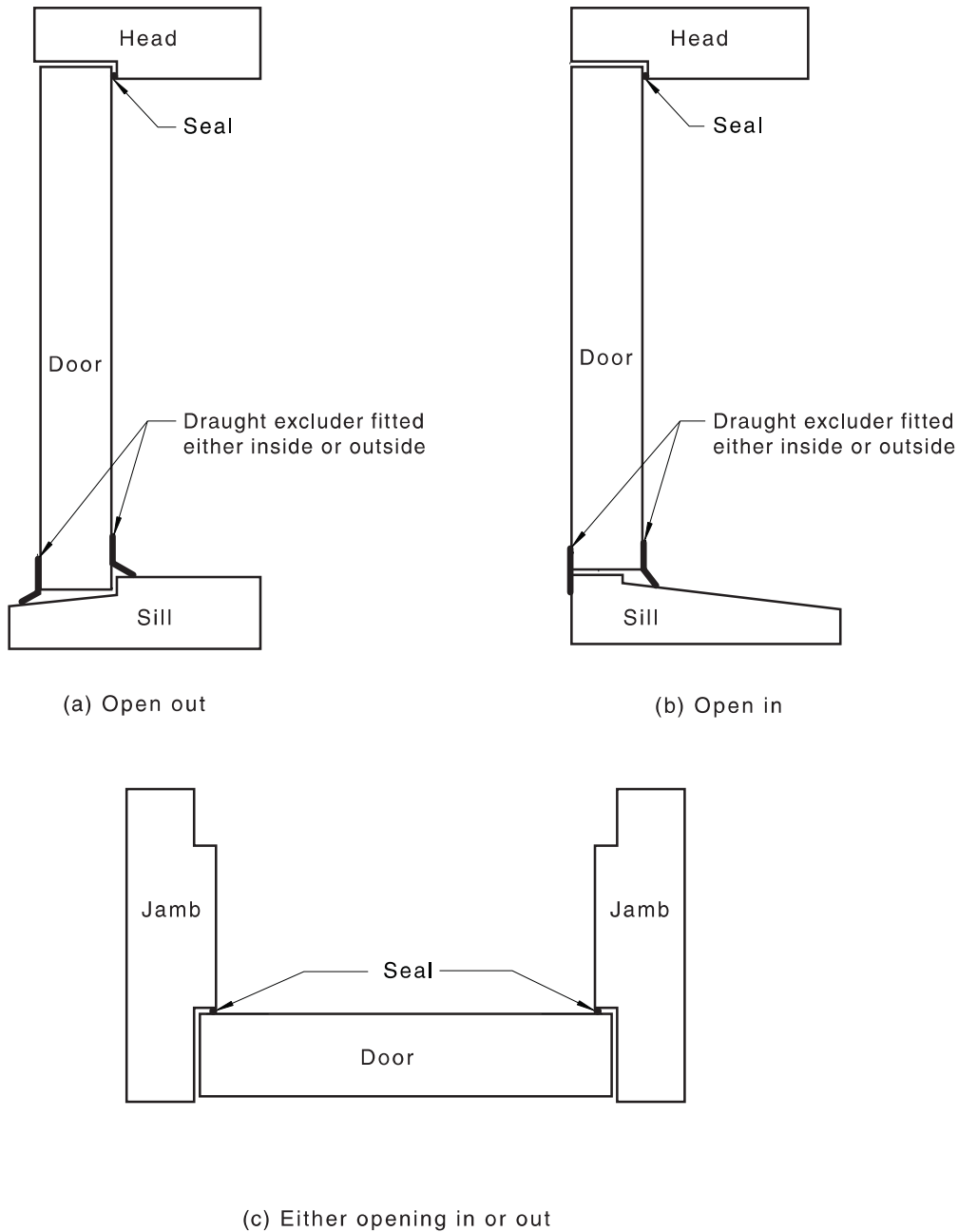

FIGURE 3.2 GAPS BETWEEN DOORS AND THE DOOR JAMBS, HEADS OR SILLS (THRESHOLDS)

3.7 BUSHFIRE SHUTTERS

Bushfire shutters shall—

- (a) protect the entire window assembly including framing, glazing, sash and sill;
- (b) protect the entire door assembly including framing, glazing, sill and hardware;
- (c) consist of material specified in Clauses 5.5.1, 6.5.1, 7.5.1, 8.5.1 and 9.5.1 for the relevant BAL;
- (d) be fixed to the building and be non-removable;

A2

- (e) be capable of being closed manually from either inside or outside or motorised shutter systems, where they are not reliant on mains power to close;
NOTE: If power-assisted shutter systems are used then that system is powered with continuous back-up energy such as a battery system.
- (f) when in the closed position, have no gap greater than 2 mm between the shutter and the wall, frame or sill; and
- (g) where perforated, have uniformly distributed perforations with a maximum aperture of 2 mm and a perforated area no greater than 20% of the shutter.

If bushfire shutters are fitted to all external doors then at least one of those shutters shall be operable from the inside to facilitate safe egress from the building.

A2 | 3.8 TESTING OF MATERIAL, ELEMENTS OF CONSTRUCTION AND SYSTEMS TO THE AS 1530.8 SERIES

A2 | Unless otherwise specified, elements of construction and systems satisfy this Standard when tested in accordance with the AS 1530.8 series for the relevant BAL and Crib Class in Table 3.2.

A2 | Elements of construction or systems tested in accordance with AS 1530.8.1—2007 with Crib Classes A, B and C prior to the issue of this Standard are acceptable.

TABLE 3.2

A2 | TESTING OF MATERIAL, ELEMENTS OF CONSTRUCTION AND SYSTEMS

Acceptable test criteria	Relevant allowable BAL	Crib class
AS 1530.8.1	BAL—12.5 to BAL—40	AA
AS 1530.8.2	BAL—FZ	Not applicable

Where any element of construction or system satisfies the test criteria in the AS 1530.8 series without screening for ember protection, the requirements of this Standard for screening of openable parts of windows shall still apply.

Where a window protected with a shutter satisfies the test criteria of the AS 1530.8 series, the additional requirements of this Standard for screening of openable parts of windows do not apply.

NOTE: The ember protection function of tested shutter has been verified by the testing.

3.9 GLAZING

Glazing requirements shall be in accordance with Sections 5 to 9 of this Standard.

NOTES:

- 1 Where double-glazed assemblies are used, the glazing requirements provided in this Standard apply to the external face of the glazed assembly only.
- 2 Refer to AS 1288 for an explanation of the terminologies used to describe various types of glass in this Standard.

3.10 SARKING

A2

Where sarking is required in Sections 5 to 9, the flammability index shall be not greater than 5 when tested in accordance with AS 1530.2.

C3.10 *Sarking material is a principle component used to control condensation and is used for energy efficiency purposes under the NCC. It may be vapour permeable or impermeable dependant on its location within the structure. Seek independent advice regarding selection of sarking prior to installation.*

3.11 TIMBER LOG WALLS

Where the thickness of a timber log wall is specified in Sections 5, 6 and 7, two criteria are nominated, as follows:

- (a) The nominal overall thickness is the overall thickness of the wall.
- (b) The minimum thickness is the thickness of the wall at the interface of two logs in the wall.

For most log profiles, the thickness of the log at the interface with an adjacent log is less than the overall thickness of the wall.

SECTION 4 BUSHFIRE ATTACK LEVEL LOW (BAL—LOW)

This Standard does not provide construction requirements for buildings assessed in bushfire-prone areas in accordance with Section 2 as being BAL—LOW.

The Bushfire Attack Level BAL—LOW is based on insufficient risk to warrant specific bushfire construction requirements. It is predicated on low threat vegetation and non-vegetated areas (see Clause 2.2.3.2).

SECTION 5 CONSTRUCTION REQUIREMENTS FOR BAL—12.5

5.1 GENERAL

A building assessed in Section 2 as being BAL—12.5 shall conform with Section 3 and Clauses 5.2 to 5.8.

Any element of construction or system that satisfies the test criteria of AS 1530.8.1 may be used in lieu of the applicable requirements contained in Clauses 5.2 to 5.8 (see Clause 3.8).

NOTE: BAL—12.5 is primarily concerned with protection from ember attack and radiant heat up to and including 12.5 kW/m² where the site is less than 100 m from the source of bushfire attack.

5.2 SUB-FLOOR SUPPORTS

This Standard does not provide construction requirements for subfloor support where the subfloor space is enclosed with—

- (a) a wall that conforms with Clause 5.4; or
- (b) a mesh or perforated sheet with a maximum aperture of 2 mm, made of corrosion-resistant steel, bronze or aluminium; or
- (c) a combination of Items (a) and (b).

A2 | Where the subfloor space is unenclosed, the support posts, columns, stumps, piers and poles shall be constructed of —

- (i) non-combustible material; or
- (ii) bushfire-resisting timber (see Appendix F); or
- (iii) a timber species as specified in Appendix E Paragraph E1; or
- (iv) a combination of Items (i), (ii) and (iii).

NOTE: This requirement applies to the subject building only and not to verandas, decks, steps, ramps and landings (see Clause 5.7).

A2 | Combustible material should not be stored in the subfloor space as these may be ignited by embers and cause an additional impact to the building.

‘Text deleted’

5.3 FLOORS

5.3.1 General

This Standard does not provide construction requirements for concrete slabs on the ground.

5.3.2 Elevated floors

5.3.2.1 Enclosed subfloor space

This Standard does not provide construction requirements for elevated floors, including bearers, joists and flooring, where the subfloor space is enclosed with—

- (a) a wall that conforms with Clause 5.4; or
- (b) a mesh or perforated sheet with a maximum aperture of 2 mm, made of corrosion-resistant steel, bronze or aluminium; or
- A2 | (c) a combination of Items (a) and (b).

BAL—12.5**5.3.2.2 Unenclosed subfloor space**

Where the subfloor space is unenclosed, the bearers, joists and flooring, less than 400 mm above finished ground level, shall be one of the following:

- A2 | (a) Material that conform with the following:
- (i) Bearers and joists shall be—
 - (A) non-combustible; or
 - (B) bushfire-resisting timber (see Appendix F); or
 - (C) a combination of Items (A) and (B).
 - (ii) Flooring shall be—
 - (A) non-combustible; or
 - (B) bushfire-resisting timber (see Appendix F); or
 - (C) timber (other than bushfire-resisting timber), particleboard or plywood flooring where the underside is lined with sarking-type material or mineral wool insulation; or
 - (D) a combination of any of Items (A), (B) or (C);

or

- A2 | (b) A system that conforms with AS 1530.8.1.

This Standard does not provide construction requirements for elements of elevated floors, including bearers, joists and flooring, if the underside of the element is 400 mm or more above finished ground level.

5.4 WALLS**5.4.1 General**

The exposed components of an external wall that are less than 400 mm from the ground or less than 400 mm above decks, carport roofs, awnings and similar elements or fittings having an angle of less than 18 degrees to the horizontal and extending more than 110 mm in width from the wall (see Figure D3, Appendix D) shall be as follows:

- A2 | (a) Non-combustible material including the following provided the minimum thickness is 90 mm:
- (i) Full masonry or masonry veneer walls with an outer leaf of clay, concrete, calcium silicate or natural stone.
 - (ii) Precast or in situ walls of concrete or aerated concrete.
 - (iii) Earth wall including mud brick; or
- (b) Timber logs of a species with a density of 680 kg/m³ or greater at a 12% moisture content; of a minimum nominal overall thickness of 90 mm and a minimum thickness of 70 mm (see Clause 3.11); and gauge planed; or
- (c) Cladding that is fixed externally to a timber-framed or a steel-framed wall and is—
- (i) non-combustible material; or
 - (ii) fibre-cement a minimum of 6 mm in thickness; or
 - (iii) bushfire-resisting timber (see Appendix F); or
 - (iv) a timber species as specified in Paragraph E1, Appendix E; or

BAL—12.5

- A2 | (v) steel sheeting; or
- (vi) a combination of any of Items (i), (ii), (iii) (iv) or (v); or
- (d) A combination of any of Items (a), (b) or (c).

This Standard does not provide construction requirements for the exposed components of an external wall that are 400 mm or more from the ground or 400 mm or more above decks, carport roofs, awnings and similar elements or fittings having an angle less than 18 degrees to the horizontal and extending more than 110 mm in width from the wall (see Figure D3, Appendix D).

5.4.2 Joints

All joints in the external surface material of walls shall be covered, sealed, overlapped, backed or butt-jointed.

5.4.3 Vents and weepholes

Except for exclusions provided in Clause 3.6, vents and weepholes in external walls shall be screened with a mesh made of corrosion-resistant steel, bronze or aluminium.

5.5 EXTERNAL GLAZED ELEMENTS, ASSEMBLIES AND DOORS**5.5.1 Bushfire shutters**

Where fitted, bushfire shutters shall conform with Clause 3.7 and be made from—

- (a) non-combustible material; or
- (b) a timber species as specified in Paragraph E1, Appendix E; or
- (c) bushfire-resisting timber (see Appendix F); or
- (d) a combination of any of Items (a), (b) or (c).

5.5.2 Screens for windows and doors

Where fitted, screens for windows and doors shall have a mesh or perforated sheet made of corrosion-resistant steel, bronze or aluminium.

The frame supporting the mesh or perforated sheet shall be made from—

- (a) metal; or
- (b) bushfire-resisting timber (see Appendix F); or
- (c) a timber species as specified in Paragraph E2, Appendix E.

5.5.3 Windows and sidelights

Window assemblies shall:

- A2 | (a) be completely protected by a bushfire shutter that conforms with Clause 3.7 and Clause 5.5.1; or
- (b) be completely protected externally by screens that conform with Clause 3.6 and Clause 5.5.2; or

C5.5.3(A) *For Clause 5.5.3(b), the screening needs to be applied to cover the entire assembly, that is including framing, glazing, sash, sill and hardware.*

or

- A2 | (c) conform with the following:

BAL—12.5

- (i) *Frame material* For window assemblies less than 400 mm from the ground or less than 400 mm above decks, carport roofs, awnings and similar elements or fittings having an angle less than 18 degrees to the horizontal and extending more than 110 mm in width from the window frame (see Figure D3, Appendix D), window frames and window joinery shall be made from one of the following:

- (A) Bushfire-resisting timber (see Appendix F); or
- (B) A timber species as specified in Paragraph E2, Appendix E; or
- (C) Metal; or
- (D) Metal-reinforced uPVC. The reinforcing members shall be made from aluminium, stainless steel, or corrosion-resistant steel.

There are no specific restrictions on frame material for all other windows.

- (ii) *Hardware* There are no specific restrictions on hardware for windows.
- (iii) *Glazing* Where glazing is less than 400 mm from the ground or less than 400 mm above decks, carport roofs, awnings and similar elements or fittings having an angle less than 18 degrees to the horizontal and extending more than 110 mm in width from the window frame (see Figure D3, Appendix D), this glazing shall be Grade A safety glass a minimum of 4 mm in thickness or glass blocks with no restriction on glazing methods.

NOTE: Where double-glazed assemblies are used above, the requirements apply to the external pane of the glazed assembly only. For all other glazing, annealed glass may be used in accordance with AS 1288.

- (iv) *Seals and weather strips* There are no specific requirements for seals and weather strips at this BAL.
- (v) *Screens* The openable portions of windows shall be screened internally or externally with screens that conform with Clause 3.6 and Clause 5.5.2.

<p>C5.5.3(B) For Clause 5.5.3(c), screening to openable portions of all windows is required in all BALs to prevent the entry of embers to the building when the window is open.</p>
--

5.5.4 Doors—Side-hung external doors (including French doors, panel fold and bi-fold doors)

Side-hung external doors, including French doors, panel fold and bi-fold doors, shall—

- (a) be completely protected by bushfire shutters that conform with Clause 3.7 and Clause 5.5.1;
- or*
- (b) be completely protected externally by screens that conform with Clause 3.6 and Clause 5.5.2;
- or*
- (c) conform with the following:

- (i) *Door panel material* Material shall be—
- (A) non-combustible; or
 - (B) solid timber, laminated timber or reconstituted timber, having a minimum thickness of 35 mm for the first 400 mm above the threshold; or

BAL—12.5

- (C) hollow core, solid timber, laminated timber or reconstituted timber with a non-combustible kickplate on the outside for the first 400 mm above the threshold; or
- (D) hollow core, solid timber, laminated timber or reconstituted timber protected externally by a screen that conforms with Clause 5.5.2; or
- (E) for fully framed glazed door panels, the framing shall be made from metal or bushfire resisting timber (see Appendix F) or a timber species as specified in Paragraph E2, Appendix E or uPVC.
- A2 | (ii) *Door frame material* Door frame material shall be—
- (A) bushfire resisting timber (see Appendix F); or
- (B) a timber species as specified in Paragraph E2 of Appendix E; or
- (C) metal; or
- (D) metal-reinforced uPVC. The reinforcing members shall be made from aluminium, stainless steel, or corrosion-resistant steel.
- A2 | (iii) *Hardware* There are no specific requirements for hardware at this BAL.
- (iv) *Glazing* Where doors incorporate glazing, the glazing shall be Grade A safety glass a minimum of 4 mm in thickness, or glass blocks with no restriction on glazing methods.
- NOTE: Where double glazed units are used the above requirements apply to the external face of the window assembly only.
- A2 | (v) *Seals and weather strips* Weather strips, draught excluders or draught seals shall be installed.
- (vi) *Screens* There is no requirement to screen the openable part of the door at this BAL.
- (vii) Doors shall be tight-fitting to the door frame and to an abutting door, if applicable.

5.5.5 Doors—Sliding doors

Sliding doors shall—

- (a) be completely protected by a bushfire shutter that conforms with Clause 3.7 and Clause 5.5.1;
- or*
- (b) be completely protected externally by screens that conform with Clause 3.6 and Clause 5.5.2; or
- (c) conform with the following:
- (i) *Frame material* The material for door frames, including fully framed glazed doors, shall be—
- (A) bushfire-resisting timber (see Appendix F); or
- (B) a timber species as specified in Paragraph E2, Appendix E; or
- (C) metal; or
- (D) metal-reinforced uPVC and the reinforcing members shall be made from aluminium, stainless steel, or corrosion-resistant steel.
- A2 | (ii) *Hardware* There are no specific requirements for hardware at this BAL.

BAL—12.5

- | | | |
|----|--|---|
| A2 | | (iii) <i>Glazing</i> Where doors incorporate glazing, the glazing shall be Grade A safety glass a minimum of 4 mm in thickness. |
| A2 | | (iv) <i>Seals and weather strips</i> There are no specific requirements for seals and weather strips at this BAL. |
| A2 | | (v) <i>Screens</i> There is no requirement to screen the openable part of the sliding door at this BAL. |
| | | (vi) <i>Sliding panels</i> Sliding panels shall be tight-fitting in the frames. |

5.5.6 Doors—Vehicle access doors (garage doors)

The following applies to vehicle access doors:

- (a) The lower portion of a vehicle access door that is within 400 mm of the ground when the door is closed (see Figure D4, Appendix D) shall be made from—
- (i) non-combustible material; or
 - (ii) bushfire-resisting timber (see Appendix F); or
 - (iii) fibre-cement sheet a minimum of 6 mm in thickness; or
 - (iv) a timber species as specified in Paragraph E1, Appendix E; or
 - (v) a combination of any of Items (i), (ii), (iii) or (iv).
- (b) All vehicle access doors shall be protected with suitable weather strips, draught excluders, draught seals or brushes. Door assemblies fitted with guide tracks do not need edge gap protection.

NOTES:

- 1 Refer to AS/NZS 4505 for door types.
- 2 Gaps of door edges or building elements should be protected as per Section 3.

C5.5.6(b) *These guide tracks do not provide a direct passage for embers into the building.*

- (c) Vehicle access doors with ventilation slots shall be protected in accordance with Clause 3.6.

5.6 ROOFS (INCLUDING PENETRATIONS, EAVES, FASCIAS AND GABLES, AND GUTTERS AND DOWNPIPES)**5.6.1 General**

The following applies to all types of roofs and roofing systems:

- | | | |
|----|--|--|
| A2 | | (a) Roof tiles, roof sheets and roof-covering accessories shall be non-combustible. |
| | | (b) The roof/wall and roof/roof junction shall be sealed or otherwise protected in accordance with Clause 3.6. |
| A2 | | (c) Roof ventilation openings, such as gable and roof vents, shall be fitted with ember guards made of non-combustible material or a mesh or perforated sheet that conforms with Clause 3.6 and, made of corrosion-resistant steel, bronze or aluminium. |
| | | (d) Only evaporative coolers manufactured in accordance with AS/NZS 60335.2.98 shall be used. Evaporative coolers with an internal damper to prevent the entry of embers into the roof space need not be screened externally. |

BAL—12.5**5.6.2 Tiled roofs**

Tiled roofs shall be fully sarked. The sarking shall—

- (a) be located on top of the roof framing, except that the roof battens may be fixed above the sarking;
- (b) cover the entire roof area including ridges and hips; and
- (c) extend into gutters and valleys.

5.6.3 Sheet roofs

Sheet roofs shall—

- (a) be fully sarked in accordance with Clause 5.6.2, except that foil-backed insulation blankets may be installed over the battens; or
- (b) have any gaps sealed at the fascia or wall line, hips and ridges by—
 - (i) a mesh or perforated sheet that conforms with Clause 3.6 and that is made of corrosion-resistant steel, bronze or aluminium; or
 - (ii) mineral wool; or
 - (iii) other non-combustible material; or
 - (iv) a combination of any of Items (i), (ii) or (iii).

C5.6.3 *Sarking is used as a secondary form of ember protection for the roof space to account for minor gaps that may develop in sheet roofing.*

5.6.4 Veranda, carport and awning roof

The following applies to veranda, carport and awning roofs:

- (a) A veranda, carport or awning roof forming part of the main roof space [see Figure D1(a), Appendix D] shall meet all the requirements for the main roof, as specified in Clauses 5.6.1 to 5.6.6.
- (b) A veranda, carport or awning roof separated from the main roof space by an external wall [see Figures D1(b) and D1(c), Appendix D] that conforms with Clause 5.4 shall have a non-combustible roof covering, except where the roof covering is a translucent or transparent material.

NOTE: There is no requirement to line the underside of a veranda, carport or awning roof that is separated from the main roof space.

5.6.5 Roof penetrations

The following applies to roof penetrations:

- (a) Roof penetrations, including roof lights, roof ventilators, roof-mounted evaporative cooling units, aerials, vent pipes and supports for solar collectors or the like, shall be sealed. The material used to seal the penetration shall be non-combustible.
- (b) Openings in vented roof lights, roof ventilators or vent pipes shall conform with Clause 3.6 and be made of corrosion-resistant steel, bronze or aluminium.

This requirement does not apply to a room sealed gas appliance.

NOTE: A gas appliance designed such that air for combustion does not enter from, or combustion products enter into, the room in which the appliance is located.

In the case of gas appliance flues, ember guards shall not be fitted.

NOTE: AS/NZS 5601 contains requirements for gas appliance flue systems and cowls. Advice can be obtained from manufacturers and State and Territory gas technical regulators.

BAL—12.5

- A2 | (c) All overhead glazing shall be Grade A safety glass that conforms with AS 1288.
- A2 | (d) Glazed elements in roof lights and skylights may be of polymer provided a Grade A safety glass diffuser, that conforms with AS 1288, is installed under the glazing. Where glazing is an insulating glazing unit (IGU), Grade A toughened safety glass of minimum 4 mm in thickness shall be used in the outer pane of the IGU.
- A2 | (e) Flashing elements of tubular skylights may be of a fire-retardant material, provided the roof integrity is maintained by an under-flashing of a material having a flammability index not greater than 5.
- (f) Evaporative cooling units shall be fitted with non-combustible butterfly closers as close as practicable to the roof level or the unit shall be fitted with non-combustible covers with a mesh or perforated sheet with a maximum aperture of 2 mm, made of corrosion-resistant steel, bronze or aluminium.
- (g) Vent pipes made from PVC are permitted.
- (h) Eaves lighting shall be adequately sealed and not compromise the performance of the element.

5.6.6 Eaves linings, fascias and gables

The following applies to eaves linings, fascias and gables:

- (a) Gables shall conform with Clause 5.4.
- A2 | (b) Eaves penetrations shall be protected as for roof penetrations as specified in Clause 5.6.5.
- (c) Eaves ventilation openings shall be fitted with ember guards in accordance with Clause 3.6 and made of corrosion-resistant steel, bronze or aluminium.
- (d) Joints in eaves linings, fascias and gables may be sealed with plastic joining strips or timber storm moulds.

‘Text deleted’

This Standard does not provide construction requirements for fascias, bargeboards and eaves linings.

5.6.7 Gutters and downpipes

This Standard does not provide material requirements for—

- (a) gutters, with the exception of box gutters; and
- (b) downpipes.

If installed, gutter and valley leaf guards shall be non-combustible.

Box gutters shall be non-combustible and flashed at the junction with the roof with non-combustible material.

5.7 VERANDAS, DECKS, STEPS AND LANDINGS

5.7.1 General

Decking may be spaced.

There is no requirement to enclose the subfloor spaces of verandas, decks, steps, ramps or landings.

BAL—12.5

A2

C5.7.1 *Spaced decking is nominally spaced at 3 mm (in accordance with standard industry practice); however, due to the nature of timber decking with seasonal changes in moisture content, that spacing may range from 0 – 5 mm during service. It should be noted that research studies have shown that gaps at 5 mm spacing afford opportunity for embers to become lodged in between timbers, which may contribute to a fire. Larger gap spacing of 10 mm may preclude this from happening but such a spacing regime may not be practical for a timber deck.*

5.7.2 Enclosed subfloor spaces of verandas, decks, steps, ramps and landings

A2

5.7.2.1 *Material to enclose a subfloor space*

This Standard does not provide construction requirements for the material used to enclose a subfloor space except where those material are less than 400 mm from the ground.

Where the material used to enclose a subfloor space are less than 400 mm from the ground, they shall conform with Clause 5.4.

5.7.2.2 *Supports*

This Standard does not provide construction requirements for support posts, columns, stumps, stringers, piers and poles.

5.7.2.3 *Framing*

This Standard does not provide construction requirements for the framing of verandas, pergolas, decks, ramps or landings (i.e. bearers and joists).

5.7.2.4 *Decking, stair treads and the trafficable surfaces of ramps and landings*

This Standard does not provide construction requirements for decking, stair treads and the trafficable surfaces of ramps and landings that are more than 300 mm from a glazed element.

Decking, stair treads and the trafficable surfaces of ramps and landings less than 300 mm (measured horizontally at deck level) from glazed elements that are less than 400 mm (measured vertically) from the surface of the deck (see Figure D2, Appendix D) shall be made from—

- (a) non-combustible material; or
- (b) bushfire-resisting timber (see Appendix F); or
- (c) a timber species as specified in Paragraph E1, Appendix E; or
- (d) uPVC; or
- (e) a combination of any of Items (a), (b), (c) or (d).

5.7.3 Unenclosed subfloor spaces of verandas, decks, steps, ramps and landings

5.7.3.1 *Supports*

This Standard does not provide construction requirements for support posts, columns, stumps, stringers, piers and poles.

5.7.3.2 *Framing*

This Standard does not provide construction requirements for the framing of verandas, decks, ramps or landings (i.e. bearers and joists).

BAL—12.5

5.7.3.3 Decking, stair treads and the trafficable surfaces of ramps and landings

This Standard does not provide construction requirements for decking, stair treads and the trafficable surfaces of ramps and landings that are more than 300 mm from a glazed element.

Decking, stair treads and the trafficable surfaces of ramps and landings less than 300 mm (measured horizontally at deck level) from glazed elements that are less than 400 mm (measured vertically) from the surface of the deck (see Figure D2, Appendix D) shall be made from—

- (a) non-combustible material; or
- (b) bushfire-resisting timber (see Appendix F); or
- (c) a timber species as specified in Paragraph E1, Appendix E; or
- (d) a combination of any of Items (a), (b) or (c).

A2 |

5.7.4 Balustrades, handrails or other barriers

This Standard does not provide construction requirements for balustrades, handrails and other barriers.

5.7.5 Veranda posts

Veranda posts—

- (a) shall be timber mounted on galvanized mounted shoes or stirrups with a clearance of not less than 75 mm above the adjacent finished ground level; or
- (b) less than 400 mm (measured vertically) from the surface of the deck or ground (see Figure D2, Appendix D) shall be made from—
 - (i) non-combustible material; or
 - (ii) bushfire-resisting timber (see Appendix F); or
 - (iii) a timber species as specified in Paragraph E1, Appendix E; or
 - (iv) a combination of any of Items (a) or (b).

5.8 WATER AND GAS SUPPLY PIPES

Above-ground, exposed water supply pipes shall be metal.

External gas pipes and fittings above ground shall be of steel or copper construction having a minimum wall thickness in accordance with gas regulations or 0.9 mm whichever is the greater. The metal pipe shall extend a minimum of 400 mm within the building and 100 mm below ground.

NOTE: Refer to State and Territory gas regulations, AS/NZS 5601.1 and AS/NZS 4645.1.

<i>C5.8 Concern is raised for the protection of bottled gas installations. Location, shielding and venting of the gas bottles needs to be considered.</i>

SECTION 6 CONSTRUCTION REQUIREMENTS FOR BAL—19

6.1 GENERAL

A2 | A building assessed in Section 2 as being BAL—19 shall conform with Section 3 and Clauses 6.2 to 6.8.

Any element of construction or system that satisfies the test criteria of AS 1530.8.1 may be used in lieu of the applicable requirements contained in Clauses 6.2 to 6.8 (see Clause 3.8).

NOTE: BAL—19 is primarily concerned with protection from ember attack and radiant heat greater than 12.5 kW/m² up to and including 19 kW/m².

6.2 SUB-FLOOR SUPPORTS

This Standard does not provide construction requirements for subfloor supports where the subfloor space is enclosed with—

- (a) a wall that conforms with Clause 6.4; or
- A2 | (b) a mesh or perforated sheet with a maximum aperture of 2 mm, made of corrosion-resistant steel, bronze or aluminium; or
- (c) a combination of Items (a) and (b).

A2 | Where the subfloor space is unenclosed, the support posts, columns, stumps, piers and poles shall be constructed of—

- (i) non-combustible material; or
- (ii) bushfire-resisting timber (see Appendix F); or
- (iii) a timber species as specified in Appendix E Paragraph E1; or
- (iv) a combination of Items (i), (ii) and (iii).

NOTE: This requirement applies to the subject building only and not to verandas, decks, steps, ramps and landings (see Clause 6.7).

A2 | Combustible material should not be stored in the subfloor space as these may be ignited by embers and cause an additional impact to the building.

‘Text deleted’

6.3 FLOORS

6.3.1 General

This Standard does not provide construction requirements for concrete slabs on the ground.

6.3.2 Elevated floors

6.3.2.1 Enclosed subfloor space

This Standard does not provide construction requirements for elevated floors, including bearers, joists and flooring, where the subfloor space is enclosed with—

- (a) a wall that conforms with Clause 6.4; or
- (b) a mesh or perforated sheet with a maximum aperture of 2 mm, made of corrosion-resistant steel, bronze or aluminium; or
- (c) a combination of Items (a) and (b).

BAL—19**6.3.2.2 Unenclosed subfloor space**

Where the subfloor space is unenclosed, the bearers, joists and flooring, less than 400 mm above finished ground level, shall be one of the following:

- A2 | (a) Material that conform with the following:
- (i) Bearers and joists shall be—
 - (A) non-combustible; or
 - (B) bushfire-resisting timber (see Appendix F); or
 - (C) a combination of Items (A) and (B).
 - (ii) Flooring shall be—
 - (A) non-combustible; or
 - (B) bushfire-resisting timber (see Appendix F); or
 - (C) timber (other than bushfire-resisting timber), particleboard or plywood flooring where the underside is lined with sarking-type material or mineral wool insulation; or
 - (D) a combination of any of Items (A), (B) or (C).

or

- A2 | (b) A system that conforms with AS 1530.8.1.

This Standard does not provide construction requirements for elements of elevated floors, including bearers, joists and flooring, if the underside of the element is 400 mm or more above finished ground level.

6.4 WALLS**6.4.1 General**

The exposed components of an external wall that are less than 400 mm from the ground or less than 400 mm above decks, carport roofs, awnings and similar elements or fittings having an angle less than 18 degrees to the horizontal and extending more than 110 mm in width from the wall (see Figure D3, Appendix D) shall be as follows:

- (a) Non-combustible material including the following provided the minimum thickness is 90 mm:
- (i) Full masonry or masonry veneer walls with an outer leaf of clay, concrete, calcium silicate or natural stone.
 - (ii) Precast or in situ walls of concrete or aerated concrete.
 - (iii) Earth wall including mud brick.

or

- (b) Timber logs of a species with a density of 680 kg/m³ or greater at a 12% moisture content; of a minimum nominal overall thickness of 90 mm and a minimum thickness of 70 mm (see Clause 3.11); and gauge planed.

or

- (c) Cladding that is fixed externally to a timber-framed or a steel-framed wall and is—
- (i) non-combustible material; or
 - (ii) fibre-cement a minimum of 6 mm in thickness; or

BAL—19

- (iii) bushfire-resisting timber (see Appendix F); or
- (iv) a timber species as specified in Paragraph E1, Appendix E; or
- (v) steel sheeting; or
- (vi) a combination of any of Items (i), (ii), (iii) (iv) or (v).

or

- (d) A combination of any of Items (a), (b) or (c) above.

This Standard does not provide construction requirements for the exposed components of an external wall that are 400 mm or more from the ground or 400 mm or more above decks, carport roofs, awnings and similar elements or fittings having an angle less than 18 degrees to the horizontal and extending more than 110 mm in width from the wall (see Figure D3, Appendix D).

6.4.2 Joints

All joints in the external surface material of walls shall be covered, sealed, overlapped, backed or butt-jointed

6.4.3 Vents and weepholes

Except for exclusions provided in Clause 3.6, vents and weepholes in external walls shall be screened with a mesh made of corrosion-resistant steel, bronze or aluminium.

6.5 EXTERNAL GLAZED ELEMENTS, ASSEMBLIES AND DOORS

6.5.1 Bushfire shutters

Where fitted, bushfire shutters shall conform with Clause 3.7 and be made from—

- (a) non-combustible material; or
- (b) a timber species as specified in Paragraph E1, Appendix E; or
- (c) bushfire-resisting timber (see Appendix F); or
- (d) a combination of any of Items (a), (b), or (c).

6.5.2 Screens for windows and doors

Where fitted, screens for windows and doors shall have a mesh or perforated sheet made of corrosion-resistant steel, bronze or aluminium.

The frame supporting the mesh or perforated sheet shall be made from—

- (a) metal; or
- (b) bushfire-resisting timber (see Appendix F); or
- (c) a timber species as specified in Paragraph E2, Appendix E.

6.5.3 Windows and sidelights

Window assemblies shall—

- (a) be completely protected by a bushfire shutter that conforms with Clause 3.7 and Clause 6.5.1; or
- (b) be completely protected externally by screens that conforms with Clause 3.6 and Clause 6.5.2; or

<p>C6.5.3(b) <i>For Item (b), the screening needs to be applied to cover the entire assembly, that is including framing, glazing, sash, sill and hardware.</i></p>

A2

A2

BAL—19

(c) conform with the following:

(i) *Frame material* For window assemblies less than 400 mm from the ground or less than 400 mm above decks, carport roofs, awnings and similar elements or fittings having an angle less than 18 degrees to the horizontal and extending more than 110 mm in width from the window frame (see Figure D3, Appendix D), window frames and window joinery, shall be made from any of the following:

(A) Bushfire-resisting timber (see Appendix F).

or

(B) A timber species as specified in Paragraph E2, Appendix E.

or

(C) Metal.

or

(D) Metal-reinforced uPVC. The reinforcing members shall be made from aluminium, stainless steel, or corrosion-resistant steel.

There are no specific restrictions on frame material for all other windows.

(ii) *Hardware* There are no specific restrictions on hardware for windows.

(iii) *Glazing* Where glazing is less than 400 mm from the ground or less than 400 mm above decks, carport roofs, awnings and similar elements or fittings, having an angle less than 18 degrees to the horizontal and extending more than 110 mm in width from the window frame (see Figure D3, Appendix D), this glazing shall be toughened glass a minimum of 5 mm in thickness, or glass blocks with no restriction on glazing methods.

NOTE: Where double-glazed assemblies are used above, the requirements apply to the external pane of the glazed assembly only.

For all other glazing, annealed glass may be used in accordance with AS 1288.

(iv) *Seals and weather strips* There are no specific requirements for seals and weather strips at this BAL.

(v) *Screens* The openable portions of windows shall be screened internally or externally with screens that conform with Clause 3.6 and Clause 6.5.2.

Where annealed glass is used, both the fixed and openable portions of the window shall be screened externally with screens that conform with Clause 6.5.2.

C6.5.3(c) For Item (c), screening to openable portions of all windows is required in all BALs to prevent the entry of embers to the building when the window is open.

For Item (c)(v), screening of the openable and fixed portions of some windows is required to reduce the effects of radiant heat on annealed glass and has to be externally fixed.

For Item (c)(v), if the screening is required only to prevent the entry of embers, the screening may be fitted externally or internally.

BAL—19

6.5.4 Doors—Side-hung external doors (including French doors, panel fold and bi-fold doors)

Side-hung external doors, including French doors, panel fold and bi-fold doors, shall—

- (a) be completely protected by bushfire shutters that conform with Clause 3.7 and Clause 6.5.1;

or

- (b) be completely protected externally by screens that conform with Clause 3.6 and Clause 6.5.2;

or

- (c) conform with the following:

- A2 | (i) *Door panel material* Material shall be—
- (A) non-combustible; or
 - (B) solid timber, laminated timber or reconstituted timber, having a minimum thickness of 35 mm for the first 400 mm above the threshold; or
 - (C) hollow core, solid timber, laminated timber or reconstituted timber with a non-combustible kickplate on the outside for the first 400 mm above the threshold; or
 - (D) for fully framed glazed door panels, the framing shall be made from metal or bushfire resisting timber (see Appendix F) or a timber species as specified in Paragraph E2, Appendix E or uPVC.
- (ii) *Door frame material* Door frame material shall be—
- (A) bushfire resisting timber (See Appendix F); or
 - (B) a timber species as specified in Paragraph E2, Appendix E; or
 - (C) metal; or
 - (D) metal reinforced uPVC.

The reinforcing members shall be made from aluminium, stainless steel, or corrosion-resistant steel.

- A2 | (iii) *Hardware* There are no specific requirements for hardware at this BAL.
- (iv) *Glazing* Where doors incorporate glazing, the glazing shall be toughened glass a minimum of 5 mm in thickness.
- (v) *Seals and weather strips* Weather strips, draught excluders or draught seals shall be installed.

- A2 | (vi) *Screens* There is no requirement to screen the openable part of the door at this BAL.
- (vii) Doors shall be tight-fitting to the door frame and to an abutting door, if applicable.

6.5.5 Doors—Sliding doors

Sliding doors shall—

- A2 | (a) be completely protected by a bushfire shutter that conforms with Clause 3.7 and Clause 6.5.1;

or

BAL—19

(b) be completely protected externally by screens that conform with Clause 3.6 and Clause 6.5.2;

or

(c) conform with the following:

(i) *Frame material* The material for door frames, including fully framed glazed doors, shall be—

(A) bushfire-resisting timber (see Appendix F); or

(B) a timber species as specified in Paragraph E2, Appendix E; or

(C) metal; or

(D) metal-reinforced uPVC and the reinforcing members shall be made from aluminium, stainless steel, or corrosion-resistant steel.

A2 | (ii) *Hardware* There are no specific requirements for hardware at this BAL.

(iii) *Glazing* Where doors incorporate glazing, the glazing shall be toughened glass a minimum of 5 mm in thickness.

A2 | (iv) *Seals and weather strips* There are no specific requirements for seals and weather strips at this BAL.

(v) *Screens* There is no requirement to screen the openable part of the sliding door at this BAL.

(vi) *Sliding panels* Sliding panels shall be tight-fitting in the frames.

6.5.6 Doors—Vehicle access doors (garage doors)

The following applies to vehicle access doors:

(a) The lower portion of a vehicle access door that is within 400 mm of the ground when the door is closed (see Figure D4, Appendix D) shall be made from—

(i) non-combustible material; or

(ii) bushfire-resisting timber (see Appendix F); or

(iii) fibre-cement sheet a minimum of 6 mm in thickness; or

(iv) a timber species as specified in Paragraph E1, Appendix E; or

(v) a combination of any of Items (i), (ii), (iii) or (iv).

(b) All vehicle access doors shall be protected with suitable weather strips, draught excluders, draught seals or brushes. Door assemblies fitted with guide tracks do not need edge gap protection.

NOTES:

1 Refer to AS/NZS 4505 for door types.

2 Gaps of door edges or building elements should be protected as per Section 3.

C6.5.6(b) <i>These guide tracks do not provide a direct passage for embers into the building.</i>
--

A2 | (c) Weather strips, draught excluders, draught seals or brushes to protect edge gaps or thresholds shall be manufactured from material having a flammability index not greater than 5.

BAL—19

- (d) Vehicle access doors with ventilation slots shall be protected in accordance with Clause 3.6.

6.6 ROOFS (INCLUDING PENETRATIONS, EAVES, FASCIAS AND GABLES, AND GUTTERS AND DOWNPIPES)

6.6.1 General

The following applies to all types of roofs and roofing systems:

- (a) Roof tiles, roof sheets and roof-covering accessories shall be non-combustible.
- (b) The roof/wall and roof/roof junction shall be sealed or otherwise protected in accordance with Clause 3.6.
- (c) Roof ventilation openings, such as gable and roof vents, shall be fitted with ember guards made of non-combustible material or a mesh or perforated sheet that conforms with Clause 3.6 and made of corrosion-resistant steel, bronze or aluminium.
- (d) Only evaporative coolers manufactured in accordance with AS/NZS 60335.2.98 shall be used. Evaporative coolers with an internal damper to prevent the entry of embers into the roof space need not be screened externally.

6.6.2 Tiled roofs

Tiled roofs shall be fully sarked. The sarking shall—

- (a) be located on top of the roof framing, except that the roof battens may be fixed above the sarking;
- (b) cover the entire roof area including ridges and hips; and
- (c) extend into gutters and valleys.

6.6.3 Sheet roofs

Sheet roofs shall—

- (a) be fully sarked in accordance with Clause 6.6.2, except that foil-backed insulation blankets may be installed over the battens; or
- (b) have any gaps sealed at the fascia or wall line, hips and ridges by—
- (i) a mesh or perforated sheet that conforms with Clause 3.6 and that is made of corrosion-resistant steel, bronze or aluminium; or
 - (ii) mineral wool; or
 - (iii) other non-combustible material; or
 - (iv) a combination of any of Items (i), (ii), or (iii).

<p><i>C6.6.3 Sarking is used as a secondary form of ember protection for the roof space to account for minor gaps that may develop in sheet roofing.</i></p>

6.6.4 Veranda, carport and awning roof

The following applies to veranda, carport and awning roofs:

- (a) A veranda, carport or awning roof forming part of the main roof space [see Figure D1(a), Appendix D] shall meet all the requirements for the main roof, as specified in Clauses 6.6.1 to 6.6.6.

BAL—19

- A2 | (b) A veranda, carport or awning roof separated from the main roof space by an external wall [see Figures D1(b) and D1(c), Appendix D] that conforms with Clause 6.4 shall have a non-combustible roof covering, except where the roof covering is a translucent or transparent material.

NOTE: There is no requirement to line the underside of a veranda, carport or awning roof that is separated from the main roof space.

6.6.5 Roof penetrations

The following applies to roof penetrations:

- (a) Roof penetrations, including roof lights, roof ventilators, roof-mounted evaporative cooling units, aerials, vent pipes and supports for solar collectors or the like, shall be sealed. The material used to seal the penetration shall be non-combustible.
- (b) Openings in vented roof lights, roof ventilators or vent pipes shall conform with Clause 3.6 and be made of corrosion-resistant steel, bronze or aluminium.

This requirement does not apply to a room sealed gas appliance.

NOTE: A gas appliance designed such that air for combustion does not enter from, or combustion products enter into, the room in which the appliance is located.

In the case of gas appliance flues, ember guards shall not be fitted.

NOTE: AS/NZS 5601 contains requirements for gas appliance flue systems and cowls. Advice can be obtained from manufacturers and State and Territory gas technical regulators.

- A2 | (c) All overhead glazing shall be Grade A safety glass that conforms with AS 1288.
- (d) Glazed elements in roof lights and skylights may be of polymer, provided a Grade A safety glass diffuser, that conforms with AS 1288, is installed under the glazing. Where glazing is an insulating glazing unit (IGU), Grade A toughened safety glass of minimum 4 mm thickness shall be used in the outer pane of the IGU.
- (e) Flashing elements of tubular skylights may be of a fire-retardant material, provided the roof integrity is maintained by under-flashing of a material having a flammability index not exceeding five.
- (f) Evaporative cooling units shall be fitted with non-combustible butterfly closers as close as practicable to the roof level, or the unit shall be fitted with non-combustible covers with a mesh or perforated sheet with a maximum aperture of 2 mm, made of corrosion-resistant steel, bronze or aluminium.
- (g) Eaves lighting shall be adequately sealed and not compromise the performance of the element.

6.6.6 Eaves linings, fascias and gables

The following applies to eaves linings, fascias and gables:

- (a) Gables shall conform with Clause 6.4.
- A2 | (b) Eaves penetrations shall be protected as for roof penetrations as specified in Clause 6.6.5.
- (c) Eaves ventilation openings shall be fitted with ember guards in accordance with Clause 3.6 and made of corrosion-resistant steel, bronze or aluminium.
- (d) Joints in eaves linings, fascias and gables shall be sealed, with material such as plastic joining strips or timber storm moulds.

BAL—19

A2 | **‘Text deleted**

This Standard does not provide construction requirements for fascias, bargeboards and eaves linings.

6.6.7 Gutters and downpipes

This Standard does not provide material requirements for—

- (a) gutters, with the exception of box gutters; and
- (b) downpipes.

If installed, gutter and valley leaf guards shall be non-combustible.

Box gutters shall be non-combustible and flashed at the junction with the roof with non-combustible material.

6.7 VERANDAS, DECKS, STEPS AND LANDINGS

6.7.1 General

Decking may be spaced.

There is no requirement to enclose the subfloor spaces of verandas, decks, steps, ramps or landings.

A2 | *C6.7.1 Spaced decking is nominally spaced at 3 mm (in accordance with standard industry practice); however, due to the nature of timber decking with seasonal changes in moisture content, that spacing may range from 0 – 5 mm during service. It should be noted that research studies have shown that gaps at 5 mm spacing afford opportunity for embers to become lodged in between timbers, which may contribute to a fire. Larger gap spacing of 10 mm may preclude this from happening but such a spacing regime may not be practical for a timber deck.*

6.7.2 Enclosed subfloor spaces of verandas, decks, steps, ramps and landings

A2 | **6.7.2.1** *Material to enclose a subfloor space*

This Standard does not provide construction requirements for the material used to enclose a subfloor space except where those material are less than 400 mm from the ground.

Where the material used to enclose a subfloor space are less than 400 mm from the ground, they shall conform with Clause 6.4.

6.7.2.2 *Supports*

This Standard does not provide construction requirements for support posts, columns, stumps, stringers, piers and poles.

6.7.2.3 *Framing*

This Standard does not provide construction requirements for the framing of verandas, pergolas, decks, ramps or landings (i.e. bearers and joists).

6.7.2.4 *Decking, stair treads and the trafficable surfaces of ramps and landings*

This Standard does not provide construction requirements for decking, stair treads and the trafficable surfaces of ramps and landings that are more than 300 mm from a glazed element.

Decking, stair treads and the trafficable surfaces of ramps and landings less than 300 mm (measured horizontally at deck level) from glazed elements that are less than 400 mm (measured vertically) from the surface of the deck (see Figure D2, Appendix D) shall be made from—

BAL—19

- (a) non-combustible material; or
- (b) bushfire-resisting timber (see Appendix F); or
- (c) a timber species as specified in Paragraph E1, Appendix E; or
- (d) a combination of any of Items (a), (b), or (c).

6.7.3 Unenclosed subfloor spaces of verandas, decks, steps, ramps and landings**6.7.3.1 Supports**

This Standard does not provide construction requirements for support posts, columns, stumps, stringers, piers and poles.

6.7.3.2 Framing

This Standard does not provide construction requirements for the framing of verandas, decks, ramps or landings (i.e. bearers and joists).

6.7.3.3 Decking, stair treads and the trafficable surfaces of ramps and landings

This Standard does not provide construction requirements for decking, stair treads and the trafficable surfaces of ramps and landings that are more than 300 mm from a glazed element.

Decking, stair treads and the trafficable surfaces of ramps and landings less than 300 mm (measured horizontally at deck level) from glazed elements that are less than 400 mm (measured vertically) from the surface of the deck (see Figure D2, Appendix D) shall be made from—

- (a) non-combustible material; or
- (b) bushfire-resisting timber (see Appendix F); or
- (c) a timber species as specified in Paragraph E1, Appendix E; or
- (d) a combination of any of Items (a), (b), or (c).

6.7.4 Balustrades, handrails or other barriers

This Standard does not provide construction requirements for balustrades, handrails and other barriers.

6.7.5 Veranda posts

Veranda posts—

- (a) shall be timber mounted on galvanized mounted shoes or stirrups with a clearance of not less than 75 mm above the adjacent finished ground level; or
- (b) less than 400 mm (measured vertically) from the surface of the deck or ground (see Figure D2, Appendix D) shall be made from—
 - (i) non-combustible material; or
 - (ii) bushfire-resisting timber (see Appendix F); or
 - (iii) a timber species as specified in Paragraph E1, Appendix E; or
 - (iv) a combination of any of Items (a) or (b).

BAL—19**6.8 WATER AND GAS SUPPLY PIPES**

Above-ground, exposed water supply pipes shall be metal.

External gas pipes and fittings above ground shall be of steel or copper construction having a minimum wall thickness in accordance with gas regulations or 0.9 mm whichever is the greater. The metal pipe shall extend a minimum of 400 mm within the building and 100 mm below ground.

NOTE: Refer to State and Territory gas regulations, AS/NZS 5601.1 and AS/NZS 4645.1.

***C6.8** Concern is raised for the protection of bottled gas installations. Location, shielding and venting of the gas bottles needs to be considered.*

SECTION 7 CONSTRUCTION REQUIREMENTS FOR BAL—29

7.1 GENERAL

A building assessed in Section 2 as being BAL—29 shall conform with Section 3 and Clauses 7.2 to 7.8.

Any element of construction or system that satisfies the test criteria of AS 1530.8.1 may be used in lieu of the applicable requirements contained in Clauses 7.2 to 7.8 (see Clause 3.8).

NOTE: BAL—29 is primarily concerned with protection from ember attack and radiant heat greater than 19 kW/m² up to and including 29 kW/m².

7.2 SUB-FLOOR SUPPORTS

This Standard does not provide construction requirements for subfloor supports where the subfloor space is enclosed with—

- (a) a wall that conforms with Clause 7.4, except that sarking is not required where specified in Clause 7.4.1(c); or
- (b) a mesh or perforated sheet with a maximum aperture of 2 mm, made of corrosion-resistant steel, bronze or aluminium; or
- (c) a combination of Items (a) and (b).

Where the subfloor space is unenclosed, the support posts, columns, stumps, piers and poles shall be—

- (i) of non-combustible material; or
- (ii) of bushfire-resisting timber (see Appendix F); or
- (iii) a combination of Items (i) and (ii).

NOTE: This requirement applies to the subject building only and not to verandas, decks, steps, ramps and landings (see Clause 7.7).

A2 | Combustible material should not be stored in the subfloor space as these may be ignited by embers and cause an additional impact to the building.

‘Text deleted’

7.3 FLOORS

7.3.1 General

This Standard does not provide construction requirements for concrete slabs on the ground.

7.3.2 Elevated floors

7.3.2.1 Enclosed subfloor space

This Standard does not provide construction requirements for elevated floors, including bearers, joists and flooring, where the subfloor space is enclosed with—

- (a) a wall that conforms with Clause 7.4; except that sarking is not required where specified in Clause 7.4.1(c); or
- (b) a mesh or perforated sheet with a maximum aperture of 2 mm, made of corrosion-resistant steel, bronze or aluminium; or
- (c) a combination of Items (a) and (b).

BAL—29**7.3.2.2 Unenclosed subfloor space**

Where the subfloor space is unenclosed, the bearers, joists and flooring, less than 400 mm above finished ground level, shall be one of the following:

- A2 | (a) Material that conform with the following:
- (i) Bearers and joints shall be—
 - (A) non-combustible; or
 - (B) bushfire-resisting timber (see Appendix F); or
 - (C) a combination of Items (A) and (B).
 - (ii) Flooring shall be—
 - (A) non-combustible; or
 - (B) bushfire-resisting timber (see Appendix F); or
 - (C) timber (other than bushfire-resisting timber), particleboard or plywood flooring where the underside is lined with sarking-type material or mineral wool insulation; or
 - (D) a combination of any of Items (A), (B) or (C).

or

- A2 | (b) A system that conforms with AS 1530.8.1.

This Standard does not provide construction requirements for elements of elevated floors, including bearers, joists and flooring, if the underside of the element is 400 mm or more above finished ground level.

7.4 WALLS**7.4.1 General**

The exposed components of external walls shall be as follows:

- (a) Non-combustible material including the following provided the minimum thickness is 90 mm:
- (i) Full masonry or masonry veneer walls with an outer leaf of clay, concrete, calcium silicate or natural stone.
 - (ii) Precast or in situ walls of concrete or aerated concrete.
 - (iii) Earth wall including mud brick.
- or*
- A2 | (b) Timber logs of a species with a density of 680 kg/m³ or greater at a 12% moisture content; of a minimum nominal overall thickness of 90 mm and a minimum thickness of 70 mm (see Clause 3.11); and gauge planed.
- or*
- (c) Cladding that is fixed externally to a timber-framed or a steel-framed wall that is sarked on the outside of the frame, and is—
- (i) fibre-cement a minimum of 6 mm in thickness; or
 - (ii) steel sheeting; or
- A2 |

BAL—29

- (iii) bushfire-resisting timber (see Appendix F); or
- (iv) a combination of any of Items (i), (ii) or (iii).

or

- (d) A combination of any of Items (a), (b) or (c).

7.4.2 Joints

All joints in the external surface material of walls shall be covered, sealed, overlapped, backed or butt-jointed.

7.4.3 Vents and weepholes

Except for exclusions provided in Clause 3.6, vents and weepholes in external walls shall be screened with a mesh made of corrosion-resistant steel, bronze or aluminium.

7.5 EXTERNAL GLAZED ELEMENTS, ASSEMBLIES AND DOORS**7.5.1 Bushfire shutters**

Where fitted, bushfire shutters shall conform with Clause 3.7 and be made from—

- (a) non-combustible material; or
- (b) bushfire-resisting timber (see Appendix F); or
- (c) a combination of Items (a) and (b).

7.5.2 Screens for windows and doors

Where fitted, screens for windows and doors shall have a mesh or perforated sheet made of corrosion-resistant steel, bronze or aluminium.

The frame supporting the mesh or perforated sheet shall be made from—

- (a) metal; or
- (b) bushfire-resisting timber (see Appendix F).

Screen assemblies shall be attached using metal fixings.

7.5.3 Windows and sidelights

Windows assemblies shall—

- (a) be completely protected by a bushfire shutter that conforms with Clause 3.7 and Clause 7.5.1;
- or*
- (b) conform with the following:
 - (i) *Frame material* Window frames and window joinery shall be made from—
 - (A) bushfire-resisting timber (see Appendix F); or
 - (B) metal; or
 - (C) metal-reinforced uPVC and the reinforcing members shall be made from aluminium, stainless steel, or corrosion-resistant steel.
 - (ii) *Hardware* Externally fitted hardware that supports the sash in its functions of opening and closing shall be metal.

C7.5.3 Components other than metal may be used provided they are shielded by the metal components of the window/door frame.

BAL—29

Trims or other components may use material other than metal.

- (iii) *Glazing* Glazing shall be toughened glass a minimum of 5 mm thickness or glass blocks with no restriction on glazing methods.

NOTE: Where double-glazed assemblies are used, the requirements apply to the external pane of the glazed assembly only.

- (iv) *Seals and weather strips* There are no specific requirements for seals and weather strips at this BAL.
- (v) *Screens* Where glazing is less than 400 mm from the ground or less than 400 mm above decks, carport roofs, awnings and similar elements or fittings having an angle less than 18 degrees to the horizontal and extending more than 110 mm in width from the window frame (see Figure D3, Appendix D), the glazing shall be screened externally with a screen that conforms with Clause 3.6 and Clause 7.5.2.
- (vi) *In all other cases except for Clause 7.5.3(b)(v)* The openable portions of windows shall be screened internally or externally with screens that conform with Clause 3.6 and Clause 7.5.2.

7.5.4 Doors—Side-hung external doors (including French doors, panel fold and bi-fold doors)

Side-hung external doors, including French doors, panel fold and bi-fold doors, shall—

- (a) be completely protected by bushfire shutters that conform with Clause 3.7 and Clause 7.5.1;
- or*
- (b) be completely protected externally by screens that conform with Clause 3.6 and Clause 7.5.2;
- or*

- (c) conform with the following:

- (i) *Door panel material* Material shall be—
- (A) non-combustible; or
- (B) solid timber, laminated timber or reconstituted timber, having a minimum thickness of 35 mm for the first 400 mm above the threshold; or
- (C) for fully framed glazed door panels, the framing shall be made from metal or from bushfire-resisting timber (see Appendix F) or uPVC.
- (ii) *Door frame material* Door frame material shall be—
- (A) bushfire resisting timber (see Appendix F); or
- (B) metal; or
- (C) metal-reinforced uPVC. The reinforcing members shall be made from aluminium, stainless steel, or corrosion resistant steel.

- (iii) *Hardware* Externally fitted hardware that supports the panel in its functions of opening and closing shall be metal.

Trims or other components may use material other than metal.

- (iv) *Glazing* Where doors incorporate glazing, the glazing shall be toughened glass a minimum of 6 mm in thickness.

BAL—29

- (v) *Seals and weather strips* Weather strips, draught excluders or draught seals shall be installed.
- (vi) *Screens* There is no requirement to screen the openable part of the door at this BAL.
- (vii) Doors shall be tight-fitting to the door frame and to an abutting door, if applicable.

7.5.5 Doors—Sliding doors

Sliding doors shall—

- (a) be completely protected by a bushfire shutter that conforms with Clause 3.7 and Clause 7.5.1;
- or*
- (b) be completely protected externally by screens that conform with Clause 3.6 and Clause 7.5.2;
- or*
- (c) conform with the following:
- (i) *Frame material* The material for door frames, including fully framed glazed doors, shall be—
- (A) bushfire-resisting timber (see Appendix F); or
- (B) metal; or
- (C) metal-reinforced uPVC and the reinforcing members shall be made from aluminium, stainless steel, or corrosion-resistant steel.
- (ii) *Hardware* Externally fitted hardware that supports the panel in its functions of opening and closing shall be metal.
- Trims or other components may use material other than metal.
- (iii) *Glazing* Where doors incorporate glazing, the glazing shall be toughened glass a minimum of 6 mm in thickness.
- (iv) *Seals and weather strips* There are no specific requirements for seals and weather strips at this BAL.
- (v) *Screens* There is no requirement to screen the openable part of the sliding door at this BAL.
- (vi) *Sliding panels* Sliding panels shall be tight-fitting in the frames.

7.5.6 Doors—Vehicle access doors (garage doors)

The following applies to vehicle access doors:

- (a) Vehicle access doors shall be made from—
- (i) non-combustible material; or
- (ii) bushfire-resisting timber (see Appendix F); or
- (iii) fibre-cement sheet, a minimum of 6 mm thickness; or
- (iv) a combination of any of Items (i), (ii) or (iii).

BAL—29

- A2 (b) All vehicle access doors shall be protected with suitable weather strips, draught excluders, draught seals or brushes. Door assemblies fitted with guide tracks do not need outer edge gap protection.

NOTES:

- 1 Refer to AS/NZS 4505 for door types.
- 2 Gaps of door edges or building elements should be protected as per Section 3.

<i>C7.5.6(b) These guide tracks do not provide a direct passage for embers into the building.</i>

- A2 (c) Weather strips, draught excluders, draught seals or brushes to protect edge gaps or thresholds shall be manufactured from material having a flammability index not greater than 5.
- (d) If minor components within the edge mechanisms of the door are made from combustible material, they shall be shielded by non-combustible components of the door assembly.
- (e) Vehicle access doors with ventilation slots shall be protected in accordance with Clause 3.6.

‘Text deleted’

7.6 ROOFS (INCLUDING PENETRATIONS, EAVES, FASCIAS AND GABLES, AND GUTTERS AND DOWNPIPES)

7.6.1 General

The following applies to all types of roofs and roofing systems:

- (a) Roof tiles, roof sheets and roof-covering accessories shall be non-combustible.
- (b) The roof/wall and roof/roof junction shall be sealed or otherwise protected in accordance with Clause 3.6.
- A2 (c) Roof ventilation openings, such as gable and roof vents, shall be fitted with ember guards made of non-combustible material or a mesh or perforated sheet that conforms with Clause 3.6 and made of corrosion-resistant steel, bronze or aluminium.
- (d) A pipe or conduit that penetrates the roof covering shall be non-combustible.
- (e) Only evaporative coolers manufactured in accordance with AS/NZS 60335.2.98 shall be used. Evaporative coolers with an internal damper to prevent the entry of embers into the roof space need not be screened externally.

7.6.2 Tiled roofs

Tiled roofs shall be fully sarked. The sarking shall—

- (a) be located on top of the roof framing, except that the roof battens may be fixed above the sarking;
- (b) cover the entire roof area including ridges and hips; and
- (c) extend into gutters and valleys.

7.6.3 Sheet roofs

Sheet roofs shall—

- (a) be fully sarked in accordance with Clause 7.6.2, except that foil-backed insulation blankets may be installed over the battens; or

BAL—29

- (b) have any gaps sealed at the fascia or wall line, hips and ridges by—
- (i) a mesh or perforated sheet that conforms with Clause 3.6 and that is made of corrosion-resistant steel, bronze or aluminium; or
 - (ii) mineral wool; or
 - (iii) other non-combustible material; or
 - (iv) a combination of any of Items (i), (ii) or (iii).

<p>C7.6.3 <i>Sarking is used as a secondary form of ember protection for the roof space to account for minor gaps that may develop in sheet roofing.</i></p>

7.6.4 Veranda, carport and awning roof

The following applies to veranda, carport and awning roofs:

- (a) A veranda, carport or awning roof forming part of the main roof space [see Figure D1(a), Appendix D] shall meet all the requirements for the main roof, as specified in Clauses 7.6.1 to 7.6.6.
- (b) A veranda, carport or awning roof separated from the main roof space by an external wall [see Figures D1(b) and D1(c), Appendix D] that conforms with Clause 7.4 shall have a non-combustible roof covering and the complete support structure shall be—
- (i) of non-combustible material; or
 - (ii) bushfire-resisting timber (see Appendix F); or
 - (iii) timber rafters lined on the underside with fibre-cement sheeting a minimum of 6 mm in thickness, or with material that conforms with AS 1530.8.1; or
 - (iv) a combination of any of Items (i), (ii) or (iii).

7.6.5 Roof penetrations

The following applies to roof penetrations:

- (a) Roof penetrations, including roof lights, roof ventilators, roof-mounted evaporative cooling units, aerials, vent pipes and supports for solar collectors or the like, shall be sealed. The material used to seal the penetration shall be non-combustible.
- (b) Openings in vented roof lights, roof ventilators or vent pipes shall conform with Clause 3.6 and the frame shall be made of corrosion-resistant steel, bronze or aluminium.

This requirement does not apply to a room sealed gas appliance.

NOTE: A gas appliance designed such that air for combustion does not enter from, or combustion products enter into, the room in which the appliance is located.

In the case of gas appliance flues, ember guards shall not be fitted.

NOTE: AS/NZS 5601 contains requirements for gas appliance flue systems and cowls. Advice can be obtained from manufacturers and State and Territory gas technical regulators.

- (c) All overhead glazing shall be Grade A safety glass that conforms with AS 1288.
- (d) Glazed elements in roof lights and skylights may be of polymer provided a Grade A safety glass diffuser, that conforms with AS 1288, is installed under the glazing. Where glazing is an insulating glazing unit (IGU), Grade A toughened safety glass of minimum 4 mm thickness shall be used in the outer pane of the IGU.

BAL—29

- (e) Flashing elements of tubular skylights shall be non-combustible. However, they may be of an alternate material, provided the integrity of the roof covering is maintained by an under-flashing made of non-combustible material.
- (f) Evaporative cooling units shall be fitted with non-combustible butterfly closers as close as practicable to the roof level, or the unit shall be fitted with non-combustible covers with a mesh or perforated sheet with a maximum aperture of 2 mm, made of corrosion-resistant steel, bronze or aluminium.
- A1 | (g) External single plane glazed elements of roof lights and skylights, where the pitch of the glazed element is 18 degrees or less to the horizontal, shall be protected with ember guards made from a mesh or perforated sheet with a maximum aperture of 2 mm, made of corrosion-resistant steel, bronze or aluminium.
- (h) Eaves lighting shall be adequately sealed and not compromise the performance of the element.

7.6.6 Eaves linings, fascias and gables

The following applies to eaves linings, fascias and gables:

- (a) Gables shall conform with Clause 7.4.
- (b) Fascias and bargeboards shall—
- (i) where timber is used, be made from bushfire-resisting timber (see Appendix F); or
 - (ii) where made from metal, be fixed at 450 mm centres; or
 - (iii) be a combination of Items (i) and (ii).
- (c) Eave linings shall be—
- (i) fibre-cement sheet, a minimum 4.5 mm in thickness; or
 - (ii) bushfire-resisting timber (see Appendix F); or
 - (iii) a combination of Items (i) and (ii).
- (d) Eave penetrations shall be protected as for roof penetrations as specified in Clause 7.6.5.
- (e) Eave ventilation openings shall be fitted with ember guards in accordance with Clause 3.6 and made of corrosion-resistant steel, bronze or aluminium.
- (f) Joints in eaves linings, fascias and gables may be sealed with plastic joining strips or timber storm moulds.

7.6.7 Gutters and downpipes

This Standard does not provide requirements for downpipes.

If installed, gutter and valley leaf guards shall be non-combustible.

With the exception of box gutters, gutters shall be metal or uPVC.

A2 | Box gutters shall be non-combustible and flashed at the junction with the roof, with non-combustible material.

7.7 VERANDAS, DECKS, STEPS AND LANDINGS**7.7.1 General**

Decking may be spaced.

BAL—29

There is no requirement to enclose the subfloor spaces of verandas, decks, steps, ramps or landings.

C7.7.1 Spaced decking is nominally spaced at 3 mm (in accordance with standard industry practice); however, due to the nature of timber decking with seasonal changes in moisture content, that spacing may range from 0 – 5 mm during service. It should be noted that research studies have shown that gaps at 5 mm spacing afford opportunity for embers to become lodged in between timbers, which may contribute to a fire. Larger gap spacing of 10 mm may preclude this from happening but such a spacing regime may not be practical for a timber deck.

7.7.2 Enclosed subfloor spaces of verandas, decks, steps, ramps and landings

7.7.2.1 Material to enclose a subfloor space

The subfloor spaces of verandas, decks, steps, ramps and landings are deemed to be 'enclosed' when—

- (a) the material used to enclose the subfloor space conforms with Clause 7.4, except that sarking is not required where specified in Clause 7.4.1(c); and
- (b) all openings are protected in accordance with Clause 3.6 and made of corrosion-resistant steel, bronze or aluminium.

7.7.2.2 Supports

This Standard does not provide construction requirements for support posts, columns, stumps, stringers, piers and poles.

7.7.2.3 Framing

This Standard does not provide construction requirements for the framing of verandas, pergolas, decks, ramps or landings (i.e. bearers and joists).

7.7.2.4 Decking, stair treads and the trafficable surfaces of ramps and landings

Decking, stair treads and the trafficable surfaces of ramps and landings shall be—

- (a) of non-combustible material; or
- (b) of bushfire-resisting timber (see Appendix F); or
- (c) a combination of Items (a) and (b).

7.7.3 Unenclosed subfloor spaces of verandas, decks, steps, ramps and landings

7.7.3.1 Supports

Support posts, columns, stumps, stringers, piers and poles shall be—

- (a) of non-combustible material; or
- (b) of bushfire-resisting timber (see Appendix F); or
- (c) a combination of Items (a) and (b).

7.7.3.2 Framing

Framing of verandas, decks, ramps or landings (i.e. bearers and joists) shall be—

- (a) of non-combustible material; or
- (b) of bushfire-resisting timber (see Appendix F); or
- (c) a combination of Items (a) and (b).

BAL—29

7.7.3.3 Decking, stair treads and the trafficable surfaces of ramps and landings

Decking, stair treads and the trafficable surfaces of ramps and landings shall be—

- (a) of non-combustible material; or
- (b) of bushfire-resisting timber (see Appendix F); or
- (c) a combination of Items (a) and (b).

7.7.4 Balustrades, handrails or other barriers

Those parts of the handrails and balustrades less than 125 mm from any glazing or any combustible wall shall be—

- (a) of non-combustible material; or
- (b) bushfire-resisting timber (see Appendix F); or
- (c) a combination of Items (a) and (b).

Those parts of the handrails and balustrades that are 125 mm or more from the building have no requirements.

7.7.5 Veranda posts

A2 | Veranda posts shall be made from —

- (a) non-combustible material; or
- (b) bushfire-resisting timber (see Appendix F); or
- (c) a combination of any of Items (a) or (b).

7.8 WATER AND GAS SUPPLY PIPES

Above-ground, exposed water supply pipes shall be metal.

External gas pipes and fittings above ground shall be of steel or copper construction having a minimum wall thickness in accordance with gas regulations or 0.9 mm whichever is the greater. The metal pipe shall extend a minimum of 400 mm within the building and 100 mm below ground.

NOTE: Refer to State and Territory gas regulations, AS/NZS 5601.1 and AS/NZS 4645.1.

<i>C7.8 Concern is raised for the protection of bottled gas installations. Location, shielding and venting of the gas bottles needs to be considered.</i>

SECTION 8 CONSTRUCTION REQUIREMENTS FOR BAL—40

8.1 GENERAL

A building assessed in Section 2 as being BAL—40 shall conform with Section 3 and Clauses 8.2 to 8.8.

Any element of construction or system that satisfies the test criteria of AS 1530.8.1 may be used in lieu of the applicable requirements of Clauses 8.2 to 8.8 (see Clause 3.8).

NOTE: BAL—40 is primarily concerned with protection from ember attack, increased likelihood of flame contact and radiant heat greater than 29 kW/m² and up to and including 40 kW/m².

8.2 SUB-FLOOR SUPPORTS

This Standard does not provide construction requirements for subfloor supports where the subfloor space is enclosed with a wall that conforms with Clause 8.4, except that sarking is not required where specified in Clause 8.4.1(b).

Where the subfloor space is unenclosed, the support posts, columns, stumps, piers and poles shall be—

- (a) of non-combustible material; or
- (b) a system that conforms with AS 1530.8.1; or
- (c) a combination of Items (a) and (b).

NOTE: This requirement applies to the subject building only and not to verandas, decks, steps, ramps and landings (see Clause 8.7).

C8.2 *Combustible material stored in the subfloor space may be ignited by embers and impact the building.*

8.3 FLOORS

8.3.1 General

This Standard does not provide construction requirements for concrete slabs on the ground.

8.3.2 Elevated floors

8.3.2.1 Enclosed subfloor space

This Standard does not provide construction requirements for elevated floors, including bearers, joists and flooring, where the subfloor space is enclosed with a wall that conforms with Clause 8.4, except that sarking is not required where specified in Clause 8.4.1(b).

8.3.2.2 Unenclosed subfloor space

Where the subfloor space is unenclosed, the bearers, joists and flooring, shall—

- (a) be non-combustible; or
- (b) have the underside of the combustible elements of the floor system protected with a non-combustible material (e.g. fibre-cement sheet or metal sheet); or
- (c) be a system that conforms with AS 1530.8.1; or
- (d) be a combination of any of Items (a), (b) or (c).

BAL—40

8.4 WALLS**8.4.1 General**

The exposed components of external walls shall be as follows:

- (a) Non-combustible material including the following provided the minimum thickness is 90 mm:
 - (i) Full masonry or masonry veneer walls with an outer leaf of clay, concrete, calcium silicate or natural stone.
 - (ii) Precast or in situ walls of concrete or aerated concrete.
 - (iii) Earth wall including mud brick.

or

- (b) Cladding that is fixed externally to a timber-framed or a steel-framed wall that is sarked on the outside of the frame and is—
 - (i) fibre-cement a minimum of 9 mm in thickness; or
 - (ii) steel; or
 - (iii) a combination of Items (i) and (ii).

A2 |

A2 |

- (c) A system that conforms with AS 1530.8.1.

or

- (d) A combination of any of Items (a), (b) or (c).

8.4.2 Joints

All joints in the external surface material of walls shall be covered, sealed, overlapped, backed or butt-jointed.

8.4.3 Vents and weepholes

Except for exclusions provided in Clause 3.6, vents and weepholes in external walls shall be screened with a mesh made of corrosion-resistant steel, bronze or aluminium.

8.5 EXTERNAL GLAZED ELEMENTS, ASSEMBLIES AND DOORS**8.5.1 Bushfire shutters**

Where fitted, bushfire shutters shall conform with Clause 3.7 and be made from non-combustible material.

8.5.2 Screens for windows and doors

Where fitted, screens for windows and doors shall have a mesh or perforated sheet made of corrosion-resistant steel or bronze.

The frame supporting the mesh or perforated sheet shall be metal.

Screen assemblies shall be attached using metal fixings.

8.5.3 Windows and sidelights

Window assemblies shall—

- (a) be completely protected by a bushfire shutter that conforms with Clause 3.7 and Clause 8.5.1;

or

BAL—40

(b) conform with the following:

- (i) *Frame material* Window frames and window joinery shall be metal.
- (ii) *Hardware* Externally fitted hardware that supports the sash in its functions of opening and closing shall be metal.

Trims or other components may use material other than metal.

A2 | (iii) *Glazing* Glazing shall be toughened glass a minimum of 6 mm in thickness or glass blocks with no restriction on glazing methods.

NOTE: Where double-glazed assemblies are used, the above requirements apply to the external face of the glazed assembly only.

A2 | (iv) *Seals and weather strips* Where used, seals and weather strips to jambs, heads and sills or thresholds shall be manufactured from material having a flammability index not greater than 5 or from silicone.

- (v) *Screens* Both the openable and fixed portions of the window shall be screened externally with screens that conform with Clause 3.6 and Clause 8.5.2.

<i>C8.5.3 Components other than metal may be used provided they are shielded by the metal components of the window/door frame.</i>

8.5.4 Doors—Side-hung external doors (including French doors, panel fold and bi-fold doors)

Side-hung external doors, including French doors, panel fold and bi-fold doors, shall—

- (a) be completely protected by bushfire shutters that conform with Clause 3.7 and Clause 8.5.1;

or

(b) conform with the following:

A2 | (i) *Door panel material* Material shall be—

- (A) non-combustible; or
- (B) solid timber having a minimum thickness of 35 mm for the first 400 mm above the threshold and protected on the outside by a metal-framed screen door with a mesh or perforated sheet that conforms with Clause 3.6 and made of corrosion-resistant steel or bronze; or
- (C) for fully framed glazed door panels the framing shall be metal.

A2 | (ii) *Door frame material* The door frame material shall be metal.

- (iii) *Hardware* Externally fitted hardware that supports the panel in its functions of opening and closing shall be metal.

A2 | Trims or other components may use material other than metal.

- (iv) *Glazing* Where doors incorporate glazing, the glazing shall be toughened glass a minimum of 6 mm in thickness.

A2 | (v) *Seals and weather strips* Weather strips, draught excluders or draught seals shall be installed to jambs, heads and sills or thresholds.

Seals to jambs, head and sills or thresholds shall be manufactured from material having a flammability index not greater than 5.

BAL—40

- A2 | (vi) *Screens* There is no requirement to screen the openable part of the door at this BAL.
- Where glazing is incorporated in the door, it shall be screened externally with screens that conform with Clause 8.5.2.
- (vii) Doors shall be tight-fitting to the door frame and to an abutting door, if applicable.

8.5.5 Doors—Sliding doors

Sliding doors shall—

- (a) be completely protected by a bushfire shutter that conforms with Clause 3.7 and Clause 8.5.1;
- or*
- (b) conform with the following:
- (i) *Frame material* The material for door frames, including fully framed glazed doors, shall be made from metal.
- (ii) *Hardware* Externally fitted hardware that supports the panel in its functions of opening and closing shall be metal.
- A2 | Trims or other components may use material other than metal.
- (iii) *Glazing* Where doors incorporate glazing, the glazing shall be toughened glass a minimum of 6 mm in thickness.
- A2 | (iv) *Seals and weather strips* Weather strips, draught excluders or draught seals shall be installed to jambs, heads and sills or thresholds. Seals to jambs, head and sills or thresholds shall be manufactured from material with a flammability index not greater than 5.
- (v) *Screens* Both the fixed and openable portions of doors shall be screened externally with screens that conform with Clause 3.6 and Clause 8.5.2.
- (vi) Sliding doors shall be tight-fitting in the frames.

8.5.6 Doors—Vehicle access doors (garage doors)

The following applies to vehicle access doors:

- (a) Vehicle access doors shall be non-combustible.
- (b) All vehicle access doors shall be protected with suitable weather strips, draught excluders, draught seals or brushes. Door assemblies fitted with guide tracks do not need edge gap protection.

NOTES:

- 1 Refer to AS/NZS 4505 for door types.
- 2 Gaps of door edges or building elements should be protected as per Section 3.

C8.5.6(b) <i>These guide tracks do not provide a direct passage for embers into the building.</i>
--

- A2 | (c) Weather strips, draught excluders, draught seals or brushes to protect edge gaps or thresholds shall be manufactured from material having a flammability index not greater than 5.

BAL—40

A2

- (d) If minor components within the edge mechanisms of the door are made from combustible material, they shall be shielded by non-combustible components of the door assembly.
- (e) Vehicle access doors shall not include ventilation slots.

‘Text deleted’

8.6 ROOFS (INCLUDING PENETRATIONS, EAVES, FASCIAS AND GABLES, AND GUTTERS AND DOWNPIPES)

8.6.1 General

The following applies to all types of roofs and roofing systems:

A2

- (a) Roof tiles, roof sheets and roof-covering accessories shall be non-combustible.
- (b) The roof/wall and roof/roof junction shall be sealed either by the use of fascia and eaves linings or by sealing between the top of the wall and the underside of the roof and between the rafters at the line of the wall. They shall also be protected in accordance with Clause 3.6.
- (c) Roof ventilation openings, such as gable and roof vents, shall be fitted with ember guards made of non-combustible material or a mesh or perforated sheet that conforms with Clause 3.6 and made of corrosion-resistant steel or bronze.
- (d) Roof-mounted evaporative coolers are not permitted in BAL—40.

8.6.2 Tiled roofs

Tiled roofs shall be fully sarked. The sarking shall—

- (a) be located on top of the roof framing, except that the roof battens may be fixed above the sarking;
- (b) cover the entire roof area including ridges and hips; and
- (c) extend into gutters and valleys.

8.6.3 Sheet roofs

Sheet roofs shall—

- (a) be fully sarked in accordance with Clause 8.6.2, except that foil-backed insulation blankets may be installed over the battens; or
- (b) have any gaps sealed at the fascia or wall line hips and ridges by—
 - (i) a mesh or perforated sheet that conforms with Clause 3.6 and that is made of corrosion-resistant steel or bronze; or
 - (ii) mineral wool; or
 - (iii) other non-combustible material; or
 - (iv) a combination of any of Items (i), (ii) or (iii).

<p>C8.6.3 <i>Sarking is used as a secondary form of ember protection for the roof space to account for minor gaps that may develop in sheet roofing.</i></p>

8.6.4 Veranda, carport and awning roof

The following applies to veranda, carport and awning roofs:

BAL—40

- (a) A veranda, carport or awning roof forming part of the main roof space [see Figure D1(a), Appendix D] shall meet all the requirements for the main roof, as specified in Clauses 8.6.1 to 8.6.6.
- (b) A veranda, carport or awning roof separated from the main roof space by an external wall [see Figures D1(b) and D1(c), Appendix D] that conforms with Clause 8.4 shall have a non-combustible roof covering and the complete support structure shall be—
- (i) of non-combustible material; or
 - (ii) timber rafters lined on the underside with fibre-cement sheeting a minimum of 6 mm in thickness, or with material that conforms with AS 1530.8.1; or
 - (iii) a system that conforms with AS 1530.8.1; or
 - (iv) a combination of any of Items (i), (ii) or (iii).

8.6.5 Roof penetrations

The following applies to roof penetrations:

- (a) Roof penetrations, including roof lights, roof ventilators, aerials, vent pipes and supports for solar collectors or the like, shall be sealed. The material used to seal the penetration shall be non-combustible.
- (b) Glazed assemblies for roof lights and skylights shall have an FRL of $-/30/-$.
- (c) External glazed elements of roof lights and skylights, where the pitch of the glazed element is 18 degrees or less to the horizontal, shall conform with Clause 3.6 and the frame shall be made of corrosion-resistant steel or bronze.
- (d) A pipe or conduit that penetrates the roof covering shall be non-combustible.

NOTE: AS/NZS 5601 contains requirements for gas appliance flue systems and cowls. Advice can be obtained from manufacturers and State and Territory gas technical regulators.

8.6.6 Eaves linings, fascias and gables

The following applies to eaves linings, fascias and gables:

- (a) Gables shall conform with Clause 8.4.
- (b) Fascias and bargeboards shall conform with AS 1530.8.1.
- (c) Eaves linings shall be—
- (i) fibre-cement sheet, a minimum of 6 mm in thickness; or
 - (ii) calcium silicate sheet, a minimum of 6 mm in thickness; or
 - (iii) a combination of Items (i) and (ii).
- (d) Eaves penetrations shall be protected as for roof penetrations as specified in Clause 8.6.5.
- (e) Eaves ventilation openings shall be fitted with ember guards in accordance with Clause 3.6 and made of corrosion-resistant steel or bronze.
- (f) Joints in eaves linings, fascias and gables may be sealed with plastic joining strips or timber storm moulds.

8.6.7 Gutters and downpipes

This Standard does not provide requirements for downpipes.

If installed, gutter and valley leaf guards shall be non-combustible.

Gutters shall be non-combustible.

BAL—40

- A2 | Box gutters shall be non-combustible and flashed at the junction with the roof with non-combustible material.

8.7 VERANDAS, DECKS, STEPS AND LANDINGS

8.7.1 General

Decking shall not be spaced.

There is no requirement to enclose the subfloor spaces of verandas, decks, steps, ramps or landings.

8.7.2 Enclosed subfloor spaces of verandas, decks, steps, ramps and landings

- A2 | **8.7.2.1** *Material to enclose a subfloor space*

The subfloor spaces of verandas, decks, steps, ramps and landings are deemed to be 'enclosed' when—

- (a) the material used to enclose the subfloor space conforms with Clause 8.4, except that sarking is not required where specified in Clause 8.4.1(b); and
- (b) all openings are protected in accordance with Clause 3.6 and made of corrosion-resistant steel or bronze.

8.7.2.2 *Supports*

This Standard does not provide construction requirements for support posts, columns, stumps, stringers, piers and poles.

8.7.2.3 *Framing*

This Standard does not provide construction requirements for the framing of verandas, pergolas, decks, ramps or landings (i.e. bearers and joists).

8.7.2.4 *Decking, stair treads and the trafficable surfaces of ramps and landings*

Decking, stair treads and the trafficable surfaces of ramps and landings shall be—

- (a) of non-combustible material; or
- A2 | (b) a system that conforms with AS 1530.8.1, or
- (c) a combination of Items (a) and (b).

8.7.3 Unenclosed subfloor spaces of verandas, decks, steps, ramps and landings

8.7.3.1 *Supports*

Support posts, columns, stumps, stringers, piers and poles shall be—

- (a) of non-combustible material; or
- A2 | (b) a system that conforms with AS 1530.8.1; or
- (c) a combination of Items (a) and (b).

8.7.3.2 *Framing*

Framing of verandas, decks, ramps or landings (i.e. bearers and joists) shall be—

- (a) of non-combustible material; or
- A2 | (b) a system that conforms with AS 1530.8.1; or
- (c) a combination of Items (a) and (b).

BAL—40

8.7.3.3 Decking, stair treads and the trafficable surfaces of ramps and landings

Decking, stair treads and the trafficable surfaces of ramps and landings shall be—

- A2 | (a) of non-combustible material; or
 (b) a system that conforms with AS 1530.8.1; or
 (c) a combination of Items (a) and (b).

8.7.4 Balustrades, handrails or other barriers

Those parts of the handrails and balustrades less than 125 mm from any glazing or any combustible wall shall be of non-combustible material.

Those parts of the handrails and balustrades that are 125 mm or more from the building have no requirements.

8.7.5 Veranda posts

Veranda posts shall be made from non-combustible material.

8.8 WATER AND GAS SUPPLY PIPES

Above-ground, exposed water supply pipes shall be metal.

External gas pipes and fittings above ground shall be of steel or copper construction having a minimum wall thickness in accordance with gas regulations or 0.9 mm whichever is the greater. The metal pipe shall extend a minimum of 400 mm within the building and 100 mm below ground.

NOTE: Refer to State and Territory gas regulations, AS/NZS 5601.1 and AS/NZS 4645.1.

<p>C8.8 <i>Concern is raised for the protection of bottled gas installations. Location, shielding and venting of the gas bottles needs to be considered.</i></p>

SECTION 9 CONSTRUCTION REQUIREMENTS FOR BAL—FZ

9.1 GENERAL

A building assessed in Section 2 as being BAL—FZ shall conform with Section 3 and Clauses 9.2 to 9.8 and have a minimum setback distance of 10 m from the edge of the classified vegetation.

In circumstances where the 10 m setback distance between the building and the edge of the classified vegetation cannot be achieved, those elements of the building that are less than 10 m from the edge of the classified vegetation shall conform with AS 1530.8.2.

The details for roof systems specified in Appendix H are the result of testing to AS 1530.8.2 and are deemed to satisfy solutions for the purpose of this Standard.

Any element of construction or system that satisfies the test criteria of AS 1530.8.2 may be used in lieu of the applicable requirements contained in Clauses 9.2 to 9.8.

NOTES:

- 1 BAL—FZ is primarily concerned with protection from flame contact together with ember attack and radiant heat of more than 40 kW/m².
- 2 Construction in BAL—FZ may require reliance on measures other than construction. The requirements for construction of a building BAL—FZ may be regulated by the building authorities having jurisdiction in the States and Territories of Australia.

9.2 SUB-FLOOR SUPPORTS

This Standard does not provide construction requirements for subfloor supports where the subfloor space is enclosed with a wall that conforms with Clause 9.4.

- A2 | Where the subfloor space is unenclosed, support posts, columns, stumps, piers and poles, shall—
- (a) have an FRL of at least 30/—/— and shall be non-combustible; or
 - A2 | (b) be a system that conforms with AS 1530.8.2; or
 - (c) be a combination of Items (a) and (b).

NOTE: This requirement applies to the subject building only and not to verandas, decks, steps, ramps and landings (see Clause 9.7).

- A2 | *C9.2 Combustible material stored in the subfloor space may be ignited by embers and impact the building.*

9.3 FLOORS

9.3.1 General

This Standard does not provide construction requirements for concrete slabs on the ground.

9.3.2 Elevated floors

9.3.2.1 Enclosed subfloor space

This Standard does not provide construction requirements for elevated floors, including bearers, joists and flooring, where the subfloor space is enclosed with a wall that conforms with Clause 9.4.

BAL—FZ

9.3.2.2 Unenclosed subfloor space

Where the subfloor space is unenclosed, the floor system, including bearers, joist and flooring, shall—

- (a) have an FRL of at least 30/30/30 and the surface material shall be non-combustible; or
- (b) have the underside of the combustible elements of the floor system protected with a 30 min resistance to incipient spread of fire system; or
- (c) conform with AS 1530.8.2 when tested from the underside; or
- (d) be a combination of any of Items (a), (b) or (c).

9.4 WALLS**9.4.1 General**

The exposed components of external walls shall be as follows:

- (a) Non-combustible material including the following provided the minimum thickness is 90 mm:
 - (i) Full masonry or masonry veneer walls with an outer leaf of clay, concrete, calcium silicate or natural stone.
 - (ii) Precast or in situ walls of concrete or aerated concrete.
 - (iii) Earth wall including mud brick.

or
- A2 | (b) A system that conforms with AS 1530.8.2 when tested from the outside.

or
- (c) A system with an FRL of 30/30/30 or –/30/30 when tested from the outside.

or
- (d) A combination of any of Items (a), (b) or (c).

9.4.2 Joints

All joints in the external surface material of walls shall be covered, sealed, overlapped, backed or butt-jointed.

9.4.3 Vents and weepholes

Except for exclusions provided in Clause 3.6, vents and weepholes in external walls shall be screened with a mesh made of corrosion-resistant steel or bronze.

9.5 EXTERNAL GLAZED ELEMENTS, ASSEMBLIES AND DOORS**9.5.1 Bushfire shutters**

Where fitted, bushfire shutters shall conform with—

- (a) Clause 3.7, except that perforations are not acceptable over the door system; and
- (b) AS 1530.8.2 when tested from the outside.

BAL—FZ

9.5.2 Screens for windows and doors

Where fitted, screens for windows and doors shall have a mesh or perforated sheet made of corrosion-resistant steel or bronze.

The frame supporting the mesh or perforated sheet shall be metal.

Screen assemblies shall be attached using metal fixings.

9.5.3 Windows and sidelights

Window assemblies shall—

- (a) be completely protected by a bushfire shutter that conforms with Clause 3.7 and Clause 9.5.1; or
- (b) the openable portion of the window shall be screened internally or externally with a screen that conforms with Clause 3.6 and Clause 9.5.2; and either—
 - (i) the window system shall have an FRL of at least $-/30/-$; or
 - (ii) the window system shall conform with AS 1530.8.2 when tested from the outside.

9.5.4 Doors—Side-hung external doors (including French doors, panel fold and bi-fold doors)

Side-hung external doors, including French doors, panel fold and bi-fold doors, shall—

- (a) be completely protected by bushfire shutters that conform with Clause 3.7 and Clause 9.5.1.
- or*
- (b) conform with the following:
 - (i) All door systems, including door frames and doors with glazed panels, shall—
 - (A) have an FRL of at least $-/30/-$; or
 - (B) conform with AS 1530.8.2 when tested from the outside.
 - (ii) Doors shall be tight-fitting to the door frame and to an abutting door, if applicable.
 - (iii) Weather strips, draught excluders or draught seals shall be installed at the base of side-hung external doors.
 - (iv) Seals shall not compromise the FRL or the performance achieved in AS 1530.4.

9.5.5 Doors—Sliding doors

Sliding doors shall—

- (a) be completely protected by a bushfire shutter that conforms with Clause 3.7 and Clause 9.5.1;
- or*
- (b) conform with the following:
 - (i) All sliding door systems, including those with glazed panels, shall—
 - (A) have an FRL of at least $-/30/-$; or
 - (B) conform with AS 1530.8.2 when tested from the outside.
 - (ii) Sliding doors shall be tight-fitting in the frames.

BAL—FZ

9.5.6 Doors—Vehicle access doors (garage doors)

The following applies to vehicle access doors:

- (a) Vehicle access doors shall be non-combustible.
- (b) Where the garage is attached to the building, the requirements of Clause 3.2.2(b) shall apply.
- (c) All vehicle access doors shall be protected with suitable weather strips, draught excluders, draught seals or brushes. Door assemblies fitted with guide tracks do not need edge gap protection.

NOTES:

- 1 Refer to AS/NZS 4505 for door types.
- 2 Gaps of door edges or building elements should be protected as per Section 3.

<i>C9.5.6(c) These guide tracks do not provide a direct passage for embers into the building.</i>

- (d) Weather strips, draught excluders, draught seals or brushes to protect edge gaps or thresholds shall be manufactured from material having a flammability index not greater than 5.
- (e) Vehicle access doors shall not include ventilation slots.

9.6 ROOFS (INCLUDING PENETRATIONS, EAVES, FASCIAS AND GABLES, AND GUTTERS AND DOWNPIPES)**9.6.1 General**

The following applies to all types of roofs and roofing systems:

- (a) The roof/wall and roof/roof junction shall be sealed either by the use of fascia and eaves linings or by sealing between the top of the wall and the underside of the roof and between the rafters at the line of the wall. They shall also be protected in accordance with Clause 3.6.
- (b) Roof ventilation openings, such as gable and roof vents, shall be fitted with ember guards made of non-combustible material or a mesh or perforated sheet that conforms with Clause 3.6 and made of corrosion-resistant steel or bronze.
- (c) Roof-mounted evaporative coolers are not permitted in BAL—FZ.

Appendix H provides two generic systems for skillion, hipped and gabled roofs which are deemed to satisfy Clause 9.6 (BAL—FZ).

9.6.2 Tiled roofs

Tiled roofs shall conform with—

- (a) Appendix H; or
- (b) a system tested to AS 1530.8.2.

9.6.3 Sheet roofs

Sheet roofs shall conform with—

- (a) Appendix H; or
- (b) a system tested to AS 1530.8.2.

BAL—FZ

9.6.4 Veranda, carport and awning roof

The following applies to veranda, carport and awning roofs:

- (a) A veranda, carport or awning roof forming part of the main roof space [see Figure D1(a), Appendix D] shall meet all the requirements for the main roof, as specified in Clause 9.6.1, 9.6.2, 9.6.3, 9.6.5 and 9.6.6.
- (b) A veranda, carport or awning roof separated from the main roof space by an external wall [see Figures D1(b) and D1(c), Appendix D] that conforms with Clause 9.4 shall have a non-combustible roof covering and the complete support structure shall be—
- (i) of non-combustible material; or
 - (ii) timber rafters lined on the underside with fibre-cement sheet a minimum of 6 mm in thickness, or with material that conforms with AS 1530.8.2; or
 - (iii) a system that conforms with AS 1530.8.2; or
 - (iv) a combination of any of Items (i), (ii) or (iii).

9.6.5 Roof penetrations

The following applies to roof penetrations:

- (a) Roof penetrations, including arials, vent pipes and supports for solar collectors or the like, shall be sealed with mineral fibre at the roof to prevent gaps. The material used to seal the penetration shall be non-combustible.

NOTE: As a general principle, the service penetration should not significantly compromise the performance of the element of construction it penetrates nor should it be a means to allow the passage of burning embers or heat transfer such that fire could spread to the interior of a structure.

- (b) Roof lights and roof ventilators shall be systems that conforms with AS 1530.8.2 when tested from the outside with one of the deemed to satisfy roof systems described in Appendix H.
- (c) Pipe or conduit that penetrates the roof covering shall conform with AS 1530.8.2.

9.6.6 Eaves linings, fascias and gables

The following applies to eaves linings, fascias and gables:

- (a) Gables shall conform with Clause 9.4.
- (b) Fascias and bargeboards shall conform with AS 1530.8.2.
- (c) Eaves linings shall be—
- (i) a system with an FRL of –/30/30; or
 - (ii) a system that conforms with AS 1530.8.2; or
 - (iii) a combination of Items (i) and (ii).
- (d) Eaves penetrations shall be protected as for roof penetrations, as specified in Clause 9.6.5.
- (e) Eaves ventilation openings shall be fitted with ember guards in accordance with Clause 3.6 and made of corrosion-resistant steel or bronze.
- (f) Joints in eaves linings, fascias and gables may be sealed with plastic joining strips or timber storm moulds.

BAL—FZ

9.6.7 Gutters and downpipes

This Standard does not provide requirements for downpipes.

If installed, gutter and valley leaf guards shall be non-combustible.

Gutters shall be non-combustible.

Box gutters shall be non-combustible and flashed at the junction with the roof with non-combustible material.

9.7 VERANDAS, DECKS, STEPS AND LANDINGS**9.7.1 General**

Decking shall not be spaced.

There is no requirement to enclose the subfloor spaces of verandas, decks, steps, ramps or landings.

9.7.2 Enclosed subfloor spaces of verandas, decks, steps, ramps and landings**9.7.2.1 Material to enclose a subfloor space**

The subfloor spaces of verandas, decks, steps, ramps and landings are deemed to be 'enclosed' when—

- (a) the material used to enclose the subfloor space conforms with Clause 9.4; and
- (b) all openings are protected in accordance with Clause 3.6 and made of corrosion-resistant steel or bronze.

9.7.2.2 Supports

This Standard does not provide construction requirements for support posts, columns, stumps, stringers, piers and poles.

9.7.2.3 Framing

This Standard does not provide construction requirements for the framing of verandas, pergolas, decks, ramps or landings (i.e. bearers and joists).

9.7.2.4 Decking, stair treads and the trafficable surfaces of ramps and landings

Decking, stair treads and the trafficable surfaces of ramps and landings shall be—

- (a) of non-combustible material; or
- (b) of fibre-cement sheet; or
- (c) a system that conforms with AS 1530.8.2; or
- (d) a combination of any of Items (a), (b) or (c).

9.7.3 Unenclosed subfloor spaces of verandas, decks, steps, ramps and landings**9.7.3.1 Supports**

Support posts, columns, stumps, stringers, piers and poles shall be—

- (a) of non-combustible material; or
- (b) a system that conforms with AS 1530.8.2; or
- (c) a combination of Items (a) and (b).

BAL—FZ

9.7.3.2 Framing

Framing of verandas, decks, ramps or landings (i.e. bearers and joists) shall be—

- A2 | (a) of non-combustible material; or
 (b) a system that conforms with AS 1530.8.2; or
 (c) a combination of Items (a) and (b).

9.7.3.3 Decking, stair treads and the trafficable surfaces of ramps and landings

Decking, stair treads and the trafficable surfaces of ramps and landings shall be—

- A2 | (a) of non-combustible material; or
 (b) fibre-cement sheet; or
 (c) a system that conforms with AS 1530.8.2; or
 (d) a combination of Items (a), (b) or (c).

9.7.4 Balustrades, handrails or other barriers

Those parts of the handrails and balustrades less than 125 mm from any glazing shall be of non-combustible material.

Those parts of the handrails and balustrades that are 125 mm or more from the building have no requirements.

9.7.5 Veranda posts

Veranda posts shall be made from non-combustible material.

9.8 WATER AND GAS SUPPLY PIPES

Above-ground, exposed water supply pipes shall be metal.

External gas pipes and fittings above ground shall be of steel or copper construction having a minimum wall thickness in accordance with gas regulations or 0.9 mm whichever is the greater. The metal pipe shall extend a minimum of 400 mm within the building and 100 mm below ground.

NOTE: Refer to State and Territory gas regulations, AS/NZS 5601.1 and AS/NZS 4645.1.

- A2 | **C9.8** *Concern is raised for the protection of bottled gas installations. Location, shielding and venting of the gas bottles needs to be considered.*

APPENDIX A
 WORKED EXAMPLE FOR THE ASSESSMENT OF BUSHFIRE
 ATTACK LEVEL (BAL)
 (Informative)

A1 GENERAL

The following criteria forms the basis of the worked example shown in Paragraph A2 for BAL determination using Method 1, set out in Section 2. Table 2.5 has been selected as a basis for this worked example and inputs used are contained in Table B1 as follows:

- (a) Relevant FDI 80.
- (b) Flame temperature 1090 K.
- (c) Slope downslope >0 to 5 degrees.
- (d) Vegetation classification Forest.
- (e) Building location 40 m from the edge of the classified vegetation.

A2 WORKED EXAMPLE

For this worked example, the table used is for FDI 80. The relevant FDI, the slope (5 degrees), vegetation classification (forest) and distance of the site (40 m) from the classified vegetation have been highlighted in the table to follow. For this example, the determined Bushfire Attack Level is BAL—19.

TABLE A1
DETERMINATION OF BUSHFIRE ATTACK LEVEL (BAL) FDI 80 (1090 K)

Vegetation classification	Bushfire attack levels (BALs)				
	BAL—FZ	BAL—40	BAL—29	BAL—19	BAL—12.5
	Distance (m) of the site from the predominant vegetation class				
	All upslopes and flat land (0 degrees)				
A. Forest	<16	16–<21	21–<31	31–<42	42–<100
B. Woodland	<10	10–<14	14–<20	20–<29	29–<100
C. Shrubland	<7	7–<9	9–<13	13–<19	19–<100
D. Scrub	<10	10–<13	13–<19	19–<27	27–<100
E. Mallee/Mulga	<6	6–<8	8–<12	12–<17	17–<100
F. Rainforest	<6	6–<9	9–<13	13–<19	19–<100
G. Grassland	<6	6–<8	8–<12	12–<17	17–<50
	Downslope >0 to 5 degrees				
A. Forest	<20	20–<27	27–<37	37–<50	50–<100
B. Woodland	<13	13–<17	17–<25	25–<35	35–<100
C. Shrubland	<7	7–<10	10–<15	15–<22	22–<100
D. Scrub	<11	11–<15	15–<22	22–<31	31–<100
E. Mallee/Mulga	<7	7–<9	9–<13	13–<20	20–<100
F. Rainforest	<8	8–<11	11–<17	17–<24	24–<100
G. Grassland	<7	7–<9	9–<14	14–<20	20–<50
	Downslope >5 to 10 degrees				
A. Forest	<26	26–<33	33–<46	46–<61	61–<100
B. Woodland	<16	16–<22	22–<31	31–<43	43–<100
C. Shrubland	<8	8–<11	11–<17	17–<25	25–<100
D. Scrub	<12	12–<17	17–<24	24–<35	35–<100
E. Mallee/Mulga	<7	7–<10	10–<15	15–<23	23–<100
F. Rainforest	<11	11–<15	15–<22	22–<31	31–<100
G. Grassland	<8	8–<10	10–<16	16–<23	23–<50
	Downslope >10 to 15 degrees				
A. Forest	<33	33–<42	42–<56	56–<73	73–<100
B. Woodland	<21	21–<28	28–<39	39–<53	53–<100
C. Shrubland	<9	9–<13	13–<19	19–<28	28–<100
D. Scrub	<14	14–<19	19–<28	28–<39	39–<100
E. Mallee/Mulga	<8	8–<11	11–<18	18–<26	26–<100
F. Rainforest	<14	14–<19	19–<28	28–<39	39–<100
G. Grassland	<9	9–<12	12–<18	18–<26	26–<50
	Downslope >15 to 20 degrees				
A. Forest	<42	42–<52	52–<68	68–<87	87–<100
B. Woodland	<27	27–<35	35–<48	48–<64	64–<100
C. Shrubland	<10	10–<15	15–<22	22–<31	31–<100
D. Scrub	<15	15–<21	21–<31	31–<43	43–<100
E. Mallee/Mulga	<9	9–<13	13–<20	20–<29	29–<100
F. Rainforest	<18	18–<25	25–<36	36–<48	48–<100
G. Grassland	<10	10–<14	14–<21	21–<30	30–<50

APPENDIX B

DETAILED METHOD FOR DETERMINING THE BUSHFIRE ATTACK LEVEL
(BAL)—METHOD 2

(Normative)

B1 GENERAL

The following procedure shall apply to determine the Bushfire Attack Level on a detailed basis for all circumstances where the effective slope under the classified vegetation is no more than 30 degrees downslope (or 15 degrees upslope) and the slope of the land between the site and the classified vegetation is no more than 20 degrees, regardless of slope type:

- (a) Step 1: Determine the relevant FDI or wind speed in accordance with Paragraph B2.
- (b) Step 2: Determine the vegetation classification, fuel loads and vegetation height in accordance with Paragraph B3.
- (c) Step 3: Determine the effective slope under the classified vegetation in accordance with Paragraph B4.
- (d) Step 4: Determine the slope, in degrees, of the land between the site and the classified vegetation in accordance with Paragraph B5.
- (e) Step 5: Determine the distance of the site from classified vegetation in accordance with Paragraph B6.
- (f) Step 6: Calculate the flame length in accordance with Paragraph B7.
- (g) Step 7: Determine flame width in accordance with Paragraph B8.
- (h) Step 8: Determine the elevation of receiver in accordance with Paragraph B9.
- (i) Step 9: Calculate the radiant heat flux in accordance with Paragraph B10.
- (j) Step 10: Determine the Bushfire Attack Level in accordance with Paragraph B11.

CB1 *The reason why the effective slope under the classified vegetation is limited to 30 degrees downslope (Ref. 1) is that convective heat from bushfire flames is no longer negligible and the relationship used to adjust the forward rate of spread for the effective slope becomes inapplicable when the effective slope is over the 30 degrees downslope limit (Ref. 2).*

The reason why the slope of the land between the site and the classified vegetation is limited to 20 degrees is that the establishment and the maintenance of the setback between the site and the vegetation may become impractical when the slope of the land between the site and the classified vegetation is over 20 degrees (Ref. 3).

The essential details of the method described in this Appendix were originally published by Douglas, G.B. and Tan, Z., 2005 (Ref. 4).

B2 STEP 1—RELEVANT FDI OR WIND SPEED

Determine the relevant FDI or wind speed as follows:

- (a) For forests, woodlands, rainforest and other forest group vegetation classifications, determine the relevant Fire Danger Index (FDI) for the site in accordance with Clause 2.2.2 or obtain other data sets provided by the relevant authority having jurisdiction for the site.

- (b) For grasslands, use Table B2.

NOTES:

- 1 Table B1 provides the relevant input values used for modelling fire behaviour including rates of spread, fire line intensity and flame height.
- 2 Wind speeds are measured and reported for a height of 10 m above ground level.

TABLE B1
INPUT VALUES USED IN MODELLING

Input name	Symbol	Unit	Values used
Vegetation classification	—	—	See Table B3 of Appendix B
Understorey fuel/Total fuel	w/W	t/ha	See Table B3 of Appendix B
Vegetation height (shrub and heath)	VH	m	See Table B3 of Appendix B
Fuel age (Tussock Moorland)	x	y (years)	20
Fuel moisture factor (Tussock Moorland)	Mf	—	5
Heat of combustion	H	kJ/kg	18 600
Fire Danger Index	FDI	—	100
			80
			50
			40
Wind speed (Shrub and Heath; Tussock Moorland)	V	km/h	45
Ambient temperature	Ta	K	308
Relative humidity	RH	%	25
Effective slope	slope	degrees	All upslopes and flat land (0 degrees) :0
			Downslope >0 to 5 degrees :5
			Downslope >5 to 10 degrees :10
			Downslope >10 to 15 degrees :15
			Downslope >15 to 20 degrees :20
Site slope	θ	degrees	Assumed to be same as effective slope for developing the prescriptive tables
Flame width	W_f	m	100
Flame emissivity	ϵ	—	0.95
Flame temperature	T	K	1090
Flame angle	α	degrees	Determined by the algorithm shown in Paragraph B10 of Appendix B
Elevation of receiver	h	m	Determined by the algorithm shown in Paragraph B9 of Appendix B
Path length	L	m	Determined by the algorithm shown in Paragraph B10 of Appendix B
Radiant heat exposure level	R_{ah}	kW/m ²	BAL—LOW BAL—12.5 BAL—19 BAL—29 BAL—40 BAL—FZ

TABLE B2
GRASSLAND FIRE DANGER INDEX VALUES
FOR USE IN TABLE B1

FDI	Grassland FDI (Purton 1982) deemed equivalent
40	50
50	70
70	100
80	110
100	130

A2

CB2 This Standard uses specified Fire Danger Index values for different regions based on the advice of local authorities (as shown in Table 2.1). The values shown are for the Forest Fire Danger Index (FFDI), calculated using the equations of Noble, I.R., Bary, G.A.V., and Gill, A.M., 1980 (Ref. 5). Grassland fire behaviour is modelled using the Grassland Fire Danger Index (GFDI) using the equations published by Purton, C.M., 1982 (Ref. 6). Since the fire behaviour model for grassland is different from those of other fuel types, there is no single mathematical relationship between values of the Forest Fire Danger Index (FFDI) and the Grassland Fire Danger Index (GFDI). In order to continue the use of Tables 2.4 to 2.7, equivalent representative values of the GFDI were selected as shown in Table B2.

A2

Thus, the specific value of the GFDI used to generate the flame length and radiant output in Paragraph B7 for Table 2.5 (FDI 80) was a GFDI of 110. Should an entirely site-specific calculation be needed then a data set should be obtained from the authority having jurisdiction for the site.

B3 STEP 2—VEGETATION CLASSIFICATION

Determine the vegetation classification in accordance with Clause 2.2.3.

A2

CB3 The vegetation classification system in Section 2 and in this Appendix is based on a national system developed by R. Specht (Ref. 7). Some States and Territories have developed their own systems for vegetation classification, which may vary in extent or description to those provided herein.

A2

For example, in NSW, a system has been established by D. Keith (Ref. 8) and fuel loads have been extensively researched for that State. This may not be comparable to other States and Territories, which may have significantly different fuel loads or different descriptions for a similar vegetation classification.

B4 STEP 3—EFFECTIVE SLOPE UNDER THE CLASSIFIED VEGETATION

Determine the effective slope (in degrees) under the classified vegetation in accordance with Clause 2.2.5.

CB4 The effective slope under the classified vegetation is not the same as average slope for the land surrounding the site of the proposed building. The effective slope is that slope which most significantly influences fire behaviour. For example, two slopes may occur in an area, one downslope and one upslope, but together they average as 0 degrees, where in practice one of the slopes will influence fire behaviour. In some cases, rocky shelf faces without vegetation cannot influence fire behaviour whereas the shelf slope itself can. In some cases, effective slope will have to be determined by survey.

B5 STEP 4—SLOPE BETWEEN SITE AND CLASSIFIED VEGETATION

Determine the slope (in degrees) of the ground between the site and the classified vegetation (Point B to Point A, see Figure 2.2).

CB5 *The slope between the site and the classified vegetation has an effect on the ‘view factor’ determined for a given position. It is the slope along the ground by line of sight between the predominant vegetation and the site.*

B6 STEP 5—DISTANCE OF THE SITE FROM CLASSIFIED VEGETATION

Determine the distance (in plan view) of the site from the classified vegetation (Point A to Point B, see Figure 2.2) in accordance with Clause 2.2.4.

B7 STEP 6—FLAME LENGTH

Flame length shall be calculated as follows:

- (a) For the vegetation classified in Clause 2.2.4, select the appropriate understorey fuel load (w), total fuel load (W) and classified vegetation height (VH) from Table B3. Both the understorey and the total fuels shall be considered in the assessment. The rate of spread (R) for forest, rainforest and woodland fires shall be determined using the understorey fuel loads. Flame heights shall be determined on the basis of both the combined understorey and overstorey fuels (total fuel loads) for forest, rainforest and woodland fires. Scrubs, shrublands and grasslands are assessed only on the basis of total fuels as there is no distinction between understorey or overstorey fuels.

TABLE B3
VEGETATION CLASSIFICATION AND FUEL LOAD

Vegetation classification (see Clause 2.2.3)	Vegetation type (see Figure 2.4)	Fuel type model	Understorey fuel load (t/ha)	Total fuel load (t/ha)	Vegetation height (m)
Forest	1, 2, 3, 4	Forest	25	35	—
Woodland	5, 7	Forest	15	25	—
Shrubland	10, 11, 12	Shrub and heath	15	15	1.5
Scrub	13, 14	Shrub and heath	25	25	3
Mallee/Mulga	15	Mallee-Heath Shrubland	8	8	3
Rainforest	16, 17, 18	Forest	10	12	—
Tussock Moorland	Not Shown	Tussock Moorland	17	17	—
Grassland	6, 8, 9, 19, 21, 22, 23, 24, 25, 26, 27, 28	McArthur Grassland	4.5	4.5	—

- (b) Determine rate of spread for the classified vegetation in accordance with Table B4.
- (c) Determine the corrected rate of spread for slope in Equation B1 below.
- (d) Determine the fire line intensity for the vegetation using Equation B2 below.
- (e) Calculate flame length in accordance with the relevant flame length equations using Equations B3, B4 or B5.

A1,
A2

TABLE B4
VEGETATION TYPES, FUEL TYPES, AND
CORRESPONDING FIRE BEHAVIOUR MODELS

Fuel types	Fire model	Fire behaviour Rate Of Spread equation
Forest, Rainforest and Woodland	Noble et al. 1980 (Ref. 5)	$R = 0.0012 * FDI * w$
Shrubland, Scrub and Mallee/Mulga	Catchpole et al. 1998 (Ref. 9)	$R = 0.023 * U_{10}^{1.21} * VH^{0.54}$
Tussock Moorland	Marsden-Smedley and Catchpole 1995 (Ref. 10)	$R = 0.024 * U_{10}^{1.312} * \exp(-0.0243 * M_f) * [1 - \exp(-0.116 * \text{age})]$
Grassland	Purton 1982 (Ref. 6)	$R = 0.13 * GFDI$

LEGEND:

 R = rate of spread (km/h) FDI = McArthur Fire Danger Index and is dimensionless w = understorey fuel load (t/ha) VH = average height of classified vegetation (m) U_{10} = average wind speed at 10 m above ground (km/h) in the open M_f = moisture factor used for Tussock Moorland only and is dimensionless MC = moisture content

age = age of vegetation used for Tussock Moorland only (yrs)

 $GFDI$ = Grassland Fire Danger Index as shown in Table B2 (A)

- (f) Correct the forward rate of spread of the fire (R) for effective slope using the following rules (Ref. 6):

$$R_{\text{slope}} = R \exp(0.069 \text{ slope}) \quad \text{for downslope} \quad \dots \text{B1}$$

$$R_{\text{slope}} = R \exp(-0.069 \text{ slope}) \quad \text{for level or upslope}$$

where

 R_{slope} = forward rate of spread adjusted for effective slope (km/h) R = forward rate of spread (km/h), determined in Item (a)

slope = effective slope (degrees), determined in Paragraph B4 above or use 15 degrees where the effective upslope is greater than 15 degrees'

- (g) Go to Item (i) below if the fuel type associated with the vegetation classification determined in Clause B3 is Forest, Woodland, Rainforest or other forest forms, otherwise calculate the fire intensity (I) in kW/m in using:

$$I = HW R_{\text{slope}}/36 \text{ (Ref. 11)} \quad \dots \text{B2}$$

where

 H = heat of combustion (18 600 kJ/kg) W = total fuel load (t/ha), determined in Table B3 above R_{slope} = adjusted forward rate of spread (km/h), determined in Paragraph B7(b)

- (h) Calculate flame length (L_f)—

For Forest, Woodland, Rainforest or other forest forms:

$$L_f = [13 R_{\text{slope}} + 0.24W]/2 \quad \text{(Ref. 3)} \quad \dots \text{B3}$$

where

 R_{slope} = forward rate of spread adjusted for slope (km/h) W = total fuel load (t/ha), determined in Paragraph B7 above

For Shrub and Heath or Mallee and Mulga or Tussock Moorland:

$$L_f = 0.0775I^{0.46} \quad (\text{Ref. 11}) \quad \dots \text{B4}$$

where

$$I = \text{fireline intensity (kW/m)}$$

For Grassland:

$$L_f = 1.192 (I/1000)^{0.5} \quad (\text{Ref. 12}) \quad \dots \text{B5}$$

where

$$I = \text{fireline intensity (kW/m)}$$

CB7 *The bushfire behaviour equations predict the head fire behaviour and are empirical in nature. These equations may not be accurate in all situations due to (a) their empirical nature and (b) the extrapolation of them beyond the original conditions under which they were developed.*

There is limited evidence supporting the relationship for adjusting the forward rate of spread on steeper slopes. Therefore, where the effective upslope is greater than 15 degrees, then 15 degrees is used.

Flame length (L_f) is taken as the sustained flame length, which adjusts the standard flame length equation for forest type vegetation (Ref. 5) reducing it by half, which takes into account flame discontinuity and adjusting for lower flame temperatures and flame geometry.

B8 STEP 7—FLAME WIDTH

Flame width is assumed to be 100 m unless the width of classified vegetation and/or the relative orientation between the classified vegetation and the site justify the use of a lesser value.

B9 STEP 8—ELEVATION OF RECEIVER

The elevation of the receiver (h) refers to the level at which the site will receive the incident radiant heat flux and it is to be measured from the ground level of the site (see Figure B1). Depending on the purpose of the assessment, it shall be determined as follows:

- (a) If the purpose of the assessment is to determine the radiant heat flux to which a specific level of the site might be exposed (for instance the window level), the elevation of the receiver shall be taken at that specific level (see Figure B1). For all other purposes, the elevation of the receiver shall take the level giving the maximum view and shall be determined in accordance with Item (b) or (c) below.
- (b) To determine the radiant heat flux for a site where the flame centre is equal to or lower than the ground level, then the ground level of the site is used for the purpose of assessment, i.e. $h = 0$ (m) (see Figure B2).
- (c) If the flame centre level is higher than ground level of the site, the elevation of the receiver is taken at the flame centre level, i.e. $h = 0.5 L_f \sin\alpha - d \tan\theta$ (m) (see Figure B3).

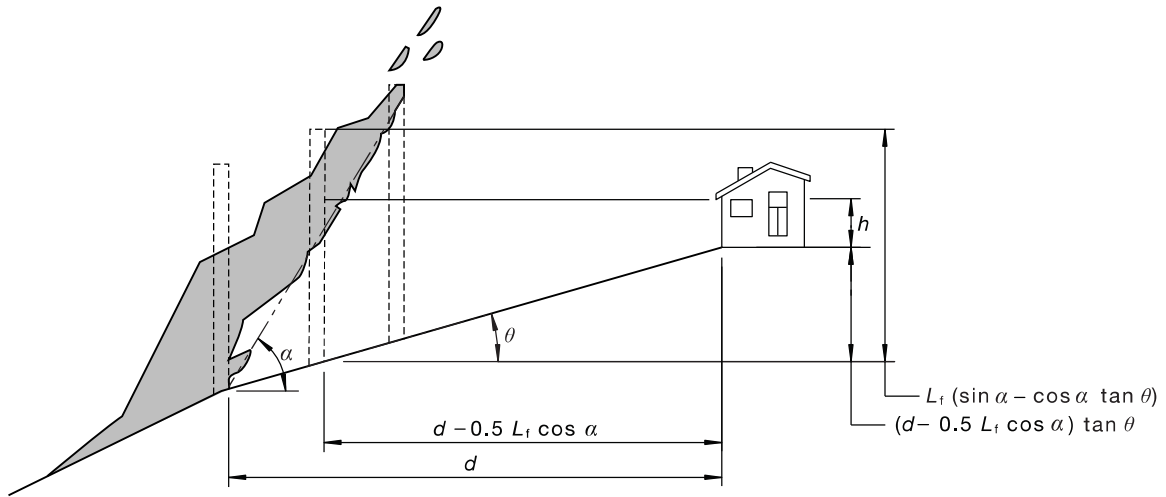

FIGURE B1 TYPICAL BUILDING AND FIRE FRONT CONFIGURATION

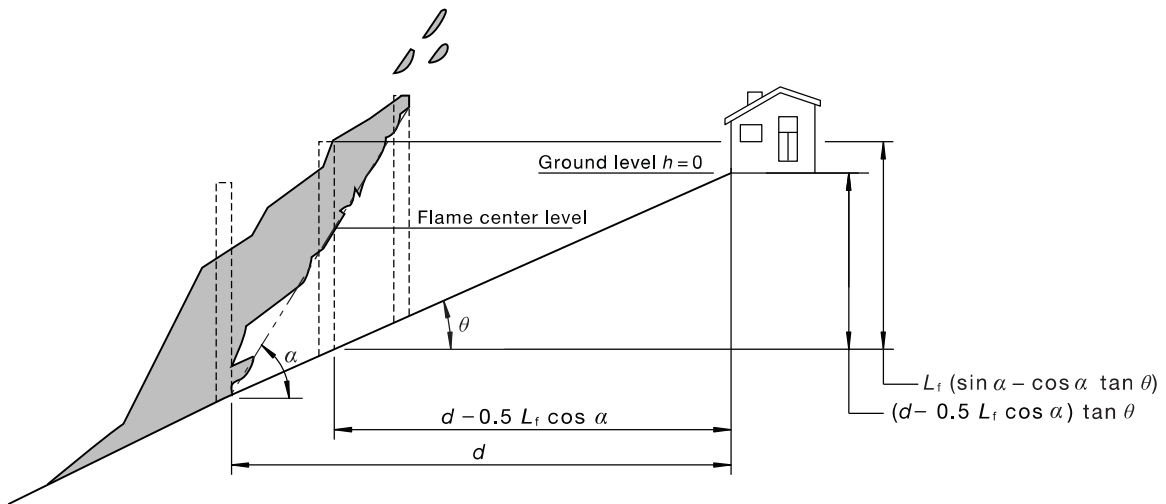

FIGURE B2 FLAME CENTRE LOWER THAN GROUND

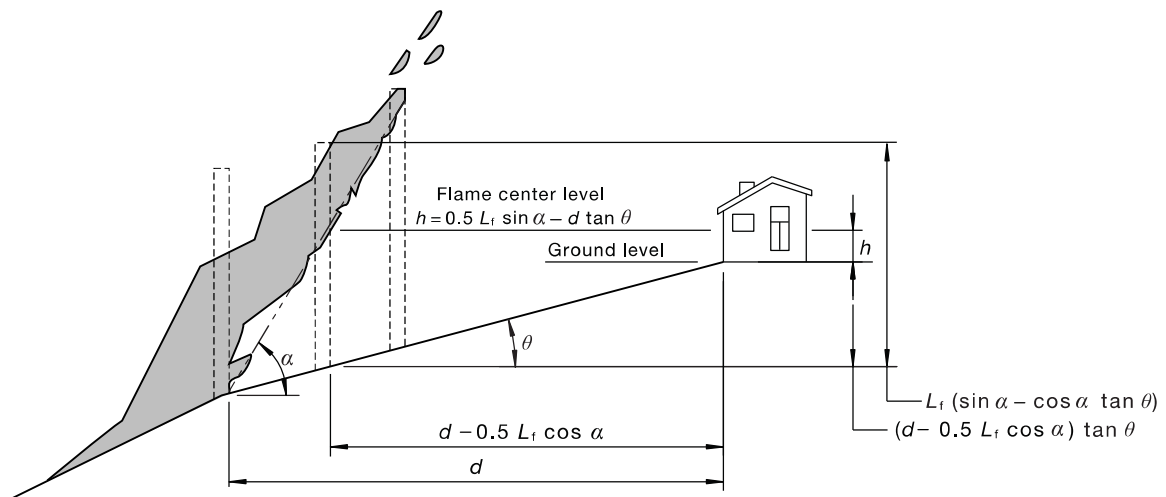

FIGURE B3 FLAME CENTRE HIGHER THAN GROUND

B10 STEP 9—RADIANT HEAT FLUX

B10.1 General

The radiant heat flux (q) in kW/m² to which the site might be exposed shall be calculated using the radiant heat transfer law with atmospheric transmissivity correction, as follows:

$$q = \tau\phi E \quad \dots B6$$

where

E = flame emissive power (kW/m²), determined in accordance with Paragraph B10.2

ϕ = view factor, determined in accordance with Paragraph B10.3

τ = atmospheric transmissivity, determined in accordance with Paragraph B10.4

B10.2 Flame emissive power

Flame emissive power (E) shall be calculated using the Stefan–Boltzmann equation, as follows:

$$E = \sigma\varepsilon T_f^4 \quad (\text{Ref. 8}) \quad \dots B7$$

where

σ = Stefan–Boltzmann constant (5.67×10^{-11} kWm⁻²K⁻⁴)

ε = flame emissivity (assumes 0.95, see Table B1)

T_f = flame temperature (assume 1090 K, see Table B1)

CB10.2 *The application of the Stefan–Boltzmann equation is based on the assumptions that a bushfire flame emits radiation as a surface and that flame temperature and emissivity are uniform across the whole flame surface (Ref. 13).*

The above assumptions are generally justified considering that the overwhelming difficulty associated with the accurate measurement of flame temperatures and flame emissivity in both laboratory and field environments as well as the level of the uncertainty resulting from the flame length modelling with the existing empirical bushfire behaviour equations.

The prediction of flame emissive power using the Stefan–Boltzmann equation necessitates the knowledge of the temperature (T_f) of the emitting flame and its emissivity (ε). A nominal flame emissivity of 0.95 is considered to be justified as the bushfire flames under design fire weather scenarios are generally optically thick ($\varepsilon \approx 1$).

The predicted flame emissive power is very sensitive to flame temperature. Therefore the selection of the nominal flame temperature for calculation is critical to make sure that the construction standard determined with this flame temperature together with other input parameters can provide an adequate level of stringency or safety at a reasonable cost.

The existing scientific literature suggests that flame temperatures for determining flame emissive power vary greatly and the majority of them fall within a range between 1000 K and 1200 K (Refs 14 and 15). An appropriate flame temperature is chosen from the above range in accordance with the minimum level of stringency or safety required by the relevant authority having jurisdiction.

B10.3 View factor

View factor or configuration factor is a geometrical factor required by calculating the radiant heat flux to which a site might be exposed, which is a function of flame geometry, location of radiant heat flux receiving element, that is, radiation receiver and relative orientation between the flame and the receiver. For the tilted flame shown in Figure B3, the view factor (ϕ) shall be calculated using one of the following:

(a) If $d \leq 0.5L_f \cos \alpha$, then $\phi = 1$

or

(b) If $d > 0.5L_f \cos \alpha$, then

$$\phi = \frac{1}{\pi} \left\{ \frac{X_1}{\sqrt{1+X_1^2}} \tan^{-1} \left[\frac{Y_1}{\sqrt{1+X_1^2}} \right] + \frac{Y_1}{\sqrt{1+Y_1^2}} \tan^{-1} \left[\frac{X_1}{\sqrt{1+Y_1^2}} \right] + \frac{X_2}{\sqrt{1+X_2^2}} \tan^{-1} \left[\frac{Y_2}{\sqrt{1+X_2^2}} \right] + \frac{Y_2}{\sqrt{1+Y_2^2}} \tan^{-1} \left[\frac{X_2}{\sqrt{1+Y_2^2}} \right] \right\} \quad \dots \text{B8}$$

$$X_1 = (L_f \sin \alpha - 0.5L_f \cos \alpha \tan \theta - d \tan \theta - h) / (d - 0.5L_f \cos \alpha)$$

$$X_2 = [h + (d - 0.5L_f \cos \alpha) \tan \theta] / (d - 0.5L_f \cos \alpha)$$

$$Y_1 = Y_2 = 0.5W_f / (d - 0.5L_f \cos \alpha)$$

where

L_f = flame length (m), determined in Paragraph B7

W_f = flame width, determined in Paragraph B8

α = flame angle (degrees), determined using the algorithm in Figure B4

θ = slope of the land between the site and the classified vegetation (degrees), determined in Paragraph B5

d = distance between the site and classified vegetation (m), determined in Paragraph B6

h = elevation of receiver (m), determined in Paragraph B9

The calculation of view factor requires the knowledge of flame length, flame width, flame angle, slope of the land between the site and the classified vegetation, distance of the site from classified vegetation, and elevation of receiver. When flame length, flame width, slope of the land between the site and the classified vegetation, distance of the site from classified vegetation and elevation of receiver are given, view factor changes with flame angle only and reaches the maximum for a flame angle between the minimum and the maximum. It is this maximum view factor that shall be used to calculate radiant heat flux so that the potential risk associated with flame angle is minimized.

The maximum view factor and the corresponding flame angle may be determined using the algorithm shown in Figure B4.

CB10.3 *The derivation of the view factor equation is based on the following assumptions:*

Assumption 1: *The view factor of an inclined flame can be approximated by that of a vertical flame with the same flame height located in the middle of the inclined flame. This assumption enables the flame tilt effect to be taken into account and it is justified by the CSIRO's laboratory experimental research findings (Ref. 15).*

Assumption 2: The radiant heat flux receiver is aligned with the vertical axis of the flame and it is paralleled to the equivalent vertical flame located in the middle of the inclined flame (see Figure B1).

The above assumptions represent a potential worst case scenario and therefore a safety factor has been implicitly incorporated into the determination of view factor.

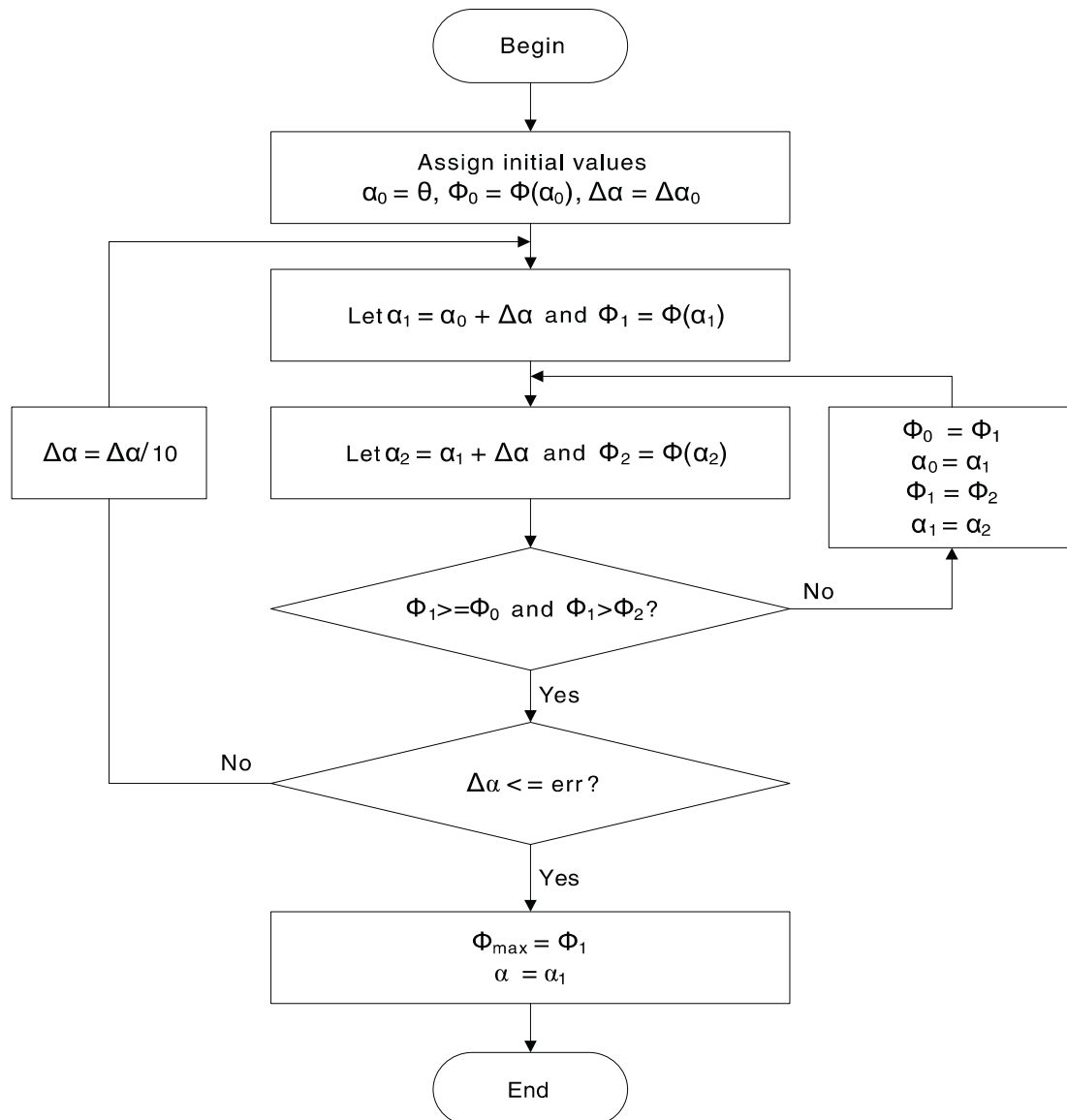

NOTE: The accuracy of the maximum view factor (Φ_{\max}) and the corresponding flame angle (α) determined using the algorithm in Figure B4 depends on the calculation error (err) specified for flame angle. A calculation error of 1 degree (i.e. $\text{err} = 1$) is usually considered to be adequate. The initial flame angle increment ($\Delta\alpha_0$) together with the predefined calculation error determines the number of iterations that need to be performed to achieve the expected calculation accuracy. If the calculation error is limited to 1 degree, then the flame angle increment ($\Delta\alpha$) may start with 10 degrees ($\Delta\alpha_0 = 10$).

FIGURE B4 FLOW DIAGRAM FOR DETERMINING MAXIMUM VIEW FACTOR AND THE CORRESPONDING FLAME ANGLE

B10.4 Atmospheric transmissivity

Atmospheric transmissivity is calculated using an empirical approach (Ref. 16), which involves the following steps:

(a) Calculate path length (L) from the following:

(i) If $d \leq 0.5L_f \cos\alpha$, then $L = 0$

or

(ii) If $d > 0.5L_f \cos\alpha$, then $L = d - 0.5L_f \cos\alpha$

where

d = distance between the site and classified vegetation (m), determined in Paragraph B6

L_f = flame length (m), determined in Paragraph B7

α = flame angle (degrees), determined in Paragraph B10.3

(b) Calculate coefficient (a_n)—

$$a_n = C_{1n} + C_{2n}T_a + C_{3n}T_f + C_{4n}RH \quad \dots B9$$

where

T_a = ambient temperature (assumes 308 K)

T_f = flame temperature, see Paragraph B10.2

RH = relative humidity (assumes 25% and expressed as 0.25)

C_{1n} , C_{2n} ,
 C_{3n} , and C_{4n} = constants defined in Table B5

(c) Calculate atmospheric transmissivity (τ) from the following:

(i) If $L = 0$, then $\tau = 1$

or

(ii) If $L \neq 0$, then $\tau = a_0 + a_1L + a_2L^2 + a_3L^3 + a_4L^4$

where

L = path length (m), determined in Paragraph B10.4(a)

a_n = coefficient determined in Paragraph B10.4(b)

TABLE B5
CONSTANTS TO CALCULATE COEFFICIENT a_n

n	C_{1n}	C_{2n}	C_{3n}	C_{4n}
0	1.486	-2.003×10^{-3}	4.68×10^{-5}	-6.052×10^{-2}
1	1.225×10^{-2}	-5.900×10^{-5}	1.66×10^{-6}	-1.759×10^{-3}
2	-1.489×10^{-4}	6.893×10^{-7}	-1.922×10^{-8}	2.092×10^{-5}
3	8.381×10^{-7}	-3.823×10^{-9}	1.0511×10^{-10}	-1.166×10^{-7}
4	-1.685×10^{-9}	7.637×10^{-12}	-2.085×10^{-13}	2.350×10^{-10}

A2

B11 STEP 10—DETERMINE THE BUSHFIRE ATTACK LEVEL

The Bushfire Attack Level and the associated construction requirements shall be determined as follows:

- (a) The Bushfire Attack Level shall be determined in accordance with Table 3.1.
- (b) The deemed to satisfy construction requirements corresponding to the Bushfire Attack Level determined in Item (a) shall be determined in accordance with the procedure shown in Figure 1.1.

REFERENCES

A2

- 1 TOLHURST, K.G. and HOWLETT, K.A. *House Ignition Likelihood Index—An Hazard Assessment Method for Land Managers in the Wildland-Urban Interface*. 10th AFAC Conference and 4th International Wildland Fire Conference, Sydney, Australia, 2003
- 2 CHENEY, N.P. Fire Behaviour. In: *Fire and the Australian Biota*, (GILL, A.M., GROVES, R.H. and NOBLE, I.R., eds). Australian Academy of Science, Canberra, 1981
- 3 NSW RURAL FIRE SERVICE. *Planning for Bushfire Protection—A Guide for Councils, Planners, Fire Authorities, Developers and Home Owners*. New South Wales Rural Fire Service, Sydney, 2001
- 4 DOUGLAS, G.B. and TAN, Z. *Integrating Site Assessment and Performance Planning Outcomes for Bushfire Prone Areas*. Symposium Planning for Natural Hazards—How Can We Mitigate the Impacts? University of Wollongong, 2–5 February 2005
- 5 NOBLE, I.R. BARY, G.A.V. and GILL, A.M. McArthur's fire-danger meters expressed as equations. *Aust. J. Ecology*. 1980, 5, 201–203
- 6 PURTON, C.M. *Equations for the McArthur Mark 4 Grassland Fire Danger Meter*. Meteorological Note 147, Bureau of Meteorology, 1982
- 7 SPECHT, R.L. Vegetation. pp. 45–67 In: *The Australian Environment*, (LEEPER, G.W., ed.). CSIRO/Melbourne University Press, 4th edition, 1970
- 8 KEITH, D.A. *Ocean Shores to Desert Dunes: The native vegetation of New South Wales and the ACT*. New South Wales Department of Environment and Conservation, 2004
- 9 CATCHPOLE, W.R., BRADSTOCK, R.A., CHOATE, J., FOGARTY, L.G., GELLIE, N., MCCARTHY, G.J., McCAW, W.L., MARSDEN-SMEDLEY, J.B. and PEARCE, G. *Cooperative Development of Equations for Heathland Fire Behaviour*. 631–645, Proceedings 3rd Int. Conf. Forest Fire Research and 14th Conf. on Fire and Forest Meteorology'. (Ed. VIEGAS, D.X.) Luso, Coimbra, Portugal, 1998
- 10 MARSDEN-SMEDLEY, J.B. and CATCHPOLE, W.R. Fire Behaviour Modelling in Tasmanian Buttongrass Moorlands II. Fire Behaviour. *Int. J. Wildland Fire*. 1995, 215–228
- 11 BYRAM, G.M. Combustion of Forest Fuels. pp. 61–89. In: *Forest Fire Control and Use*, (DAVIS, K.P., ed.). McGraw-Hill, New York, 1959
- 12 NELSON, R.M. *Flame Characteristics for Fires in Southern Fuels*. US Forest Service Research Paper SE – 205, USDA South-Eastern Forest Experiment Station, 1980
- 13 KNIGHT, I.K. AND SULLIVAN, A.L. A Semi-transparent Model of Bushfire Flames to Predict Radiant Heat Flux. *Int. J. Wildland Fire*. 2004, 13, 201–207
- 14 VINES, R.G., Physics and Chemistry of Rural Fires. In: *Fire and the Australian Biota*, (GILL, A.M., GROVES, R.H. AND NOBLE, I.R., eds). Australian Academy of Science, Canberra, 1981
- 15 SULLIVAN, A.L., ELLIS, P.F. and KNIGHT, I.K. A Review of Radiant Heat Flux Models Used in Bushfire Applications. *Int. J. Wildland Fire*, 2003, 12, 101–110
- 16 FUSS, S.P. and HAMINS, A. An Estimate of the Correction Applied to Radiant Flame Measurements Due to Attenuation by Atmospheric CO₂ and H₂O. *Fire Safety J.* 2002, 37, 181–190

APPENDIX C

PROCESS AND PROCEDURE FOR DETERMINING THE BUSHFIRE ATTACK LEVEL (BAL) USING METHOD 1

(Informative)

Figure C1 summarizes the simplified procedure (Method 1) set out in Clause 2.2.

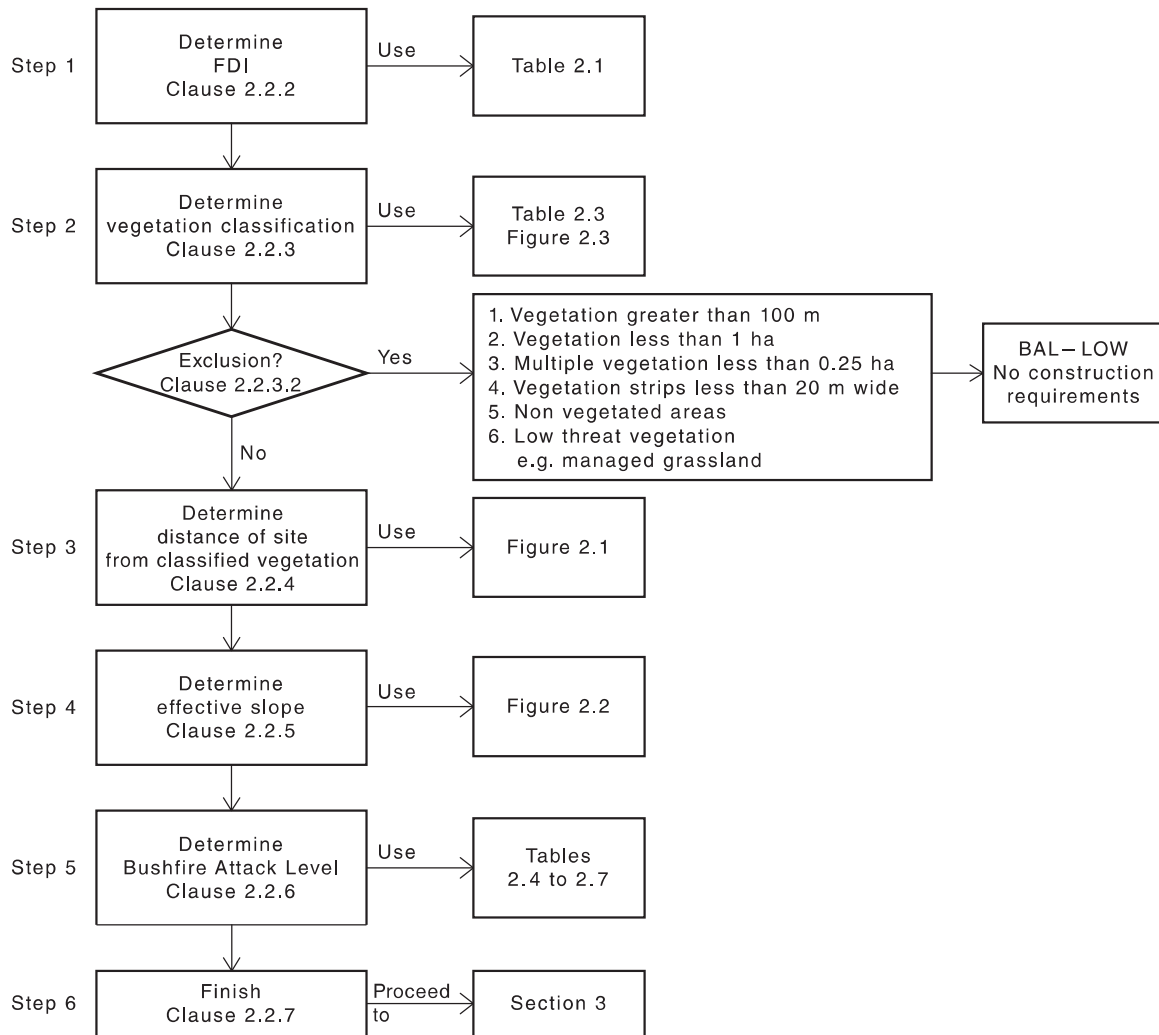

FIGURE C1 DETERMINATION OF THE BUSHFIRE ATTACK LEVEL (BAL)—METHOD 1

Copyrighted material. Licensed to TAFE NSW by Techstreet LLC. subscription: techstreet.com, downloaded on 2023-12-20 05:16:31 +0000 by TAFE NSW User. No further reproduction or distribution is permitted.

APPENDIX D
ILLUSTRATIONS

(Normative)

The following illustrations (Figures D1 to D4) support requirements of this Standard.

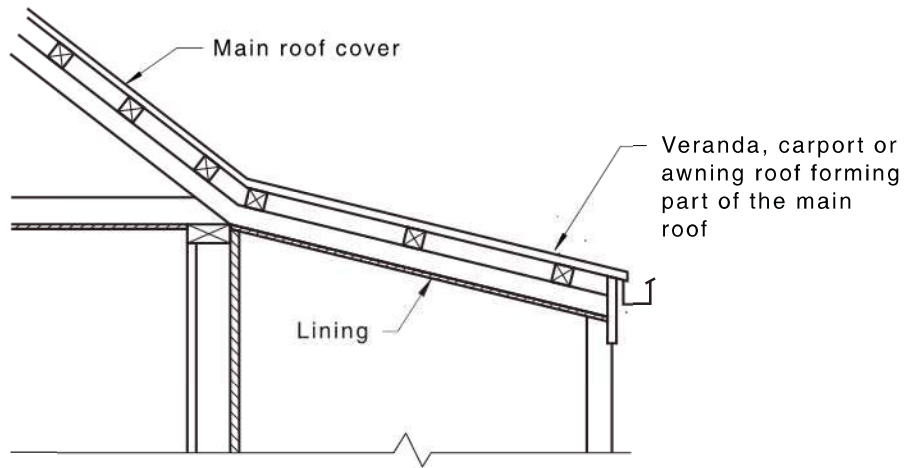

(a) Continuous roof

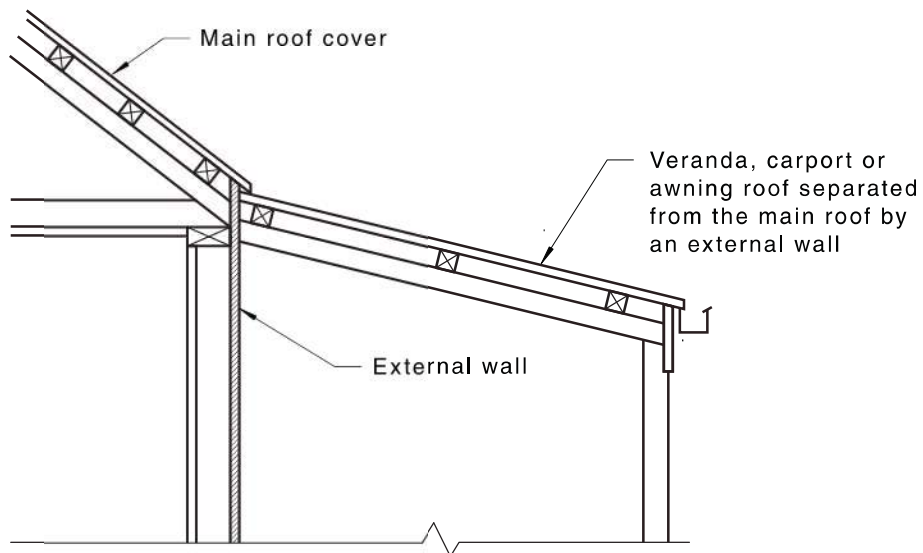

(b) Continuous roof with veranda, carport or awning roof separated from main roof

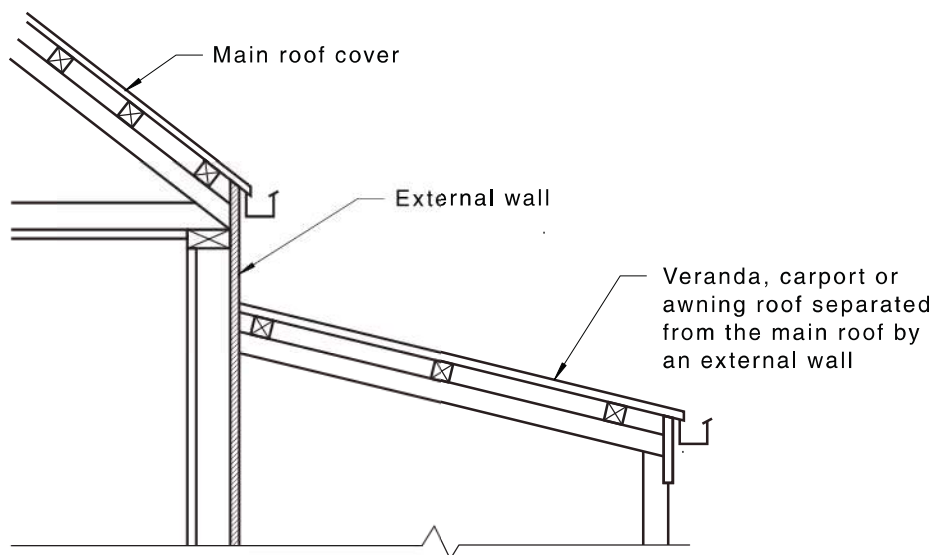

(c) Discontinuous roof

FIGURE D1 VERANDA, CARPORT OR AWNING ROOFS SHOWING CONTINUOUS AND DISCONTINUOUS ROOF TYPES

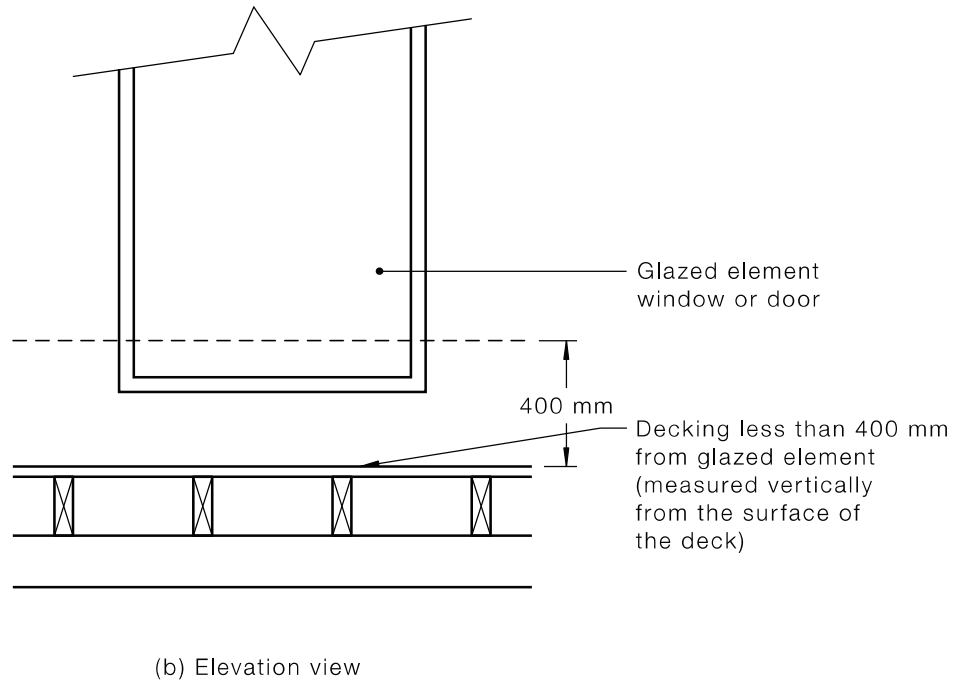
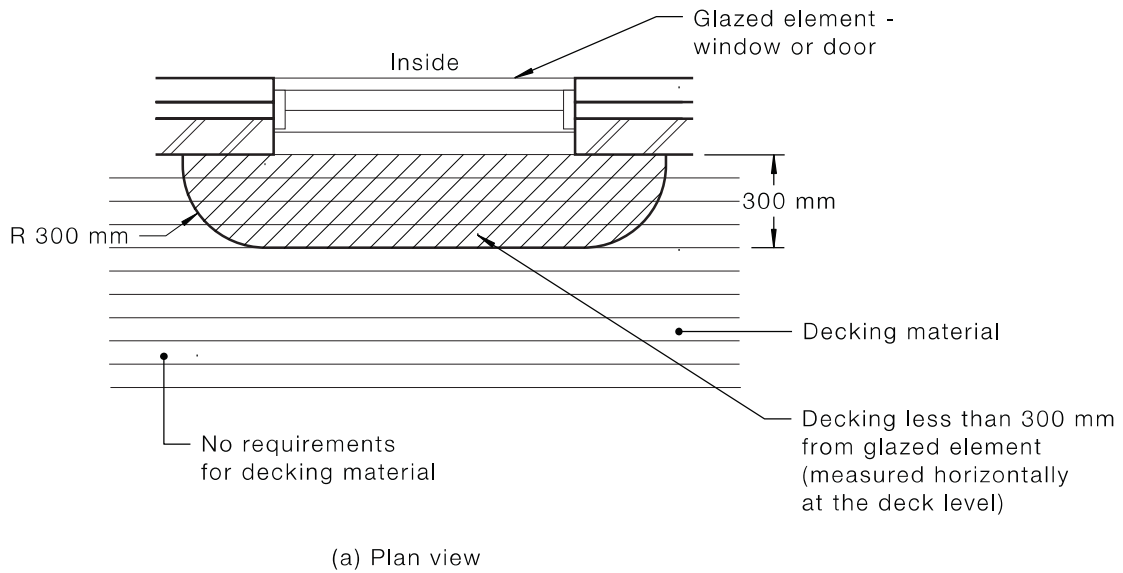

FIGURE D2 DECKING WITHIN HORIZONTAL AND VERTICAL LIMITS OF GLAZED ELEMENTS

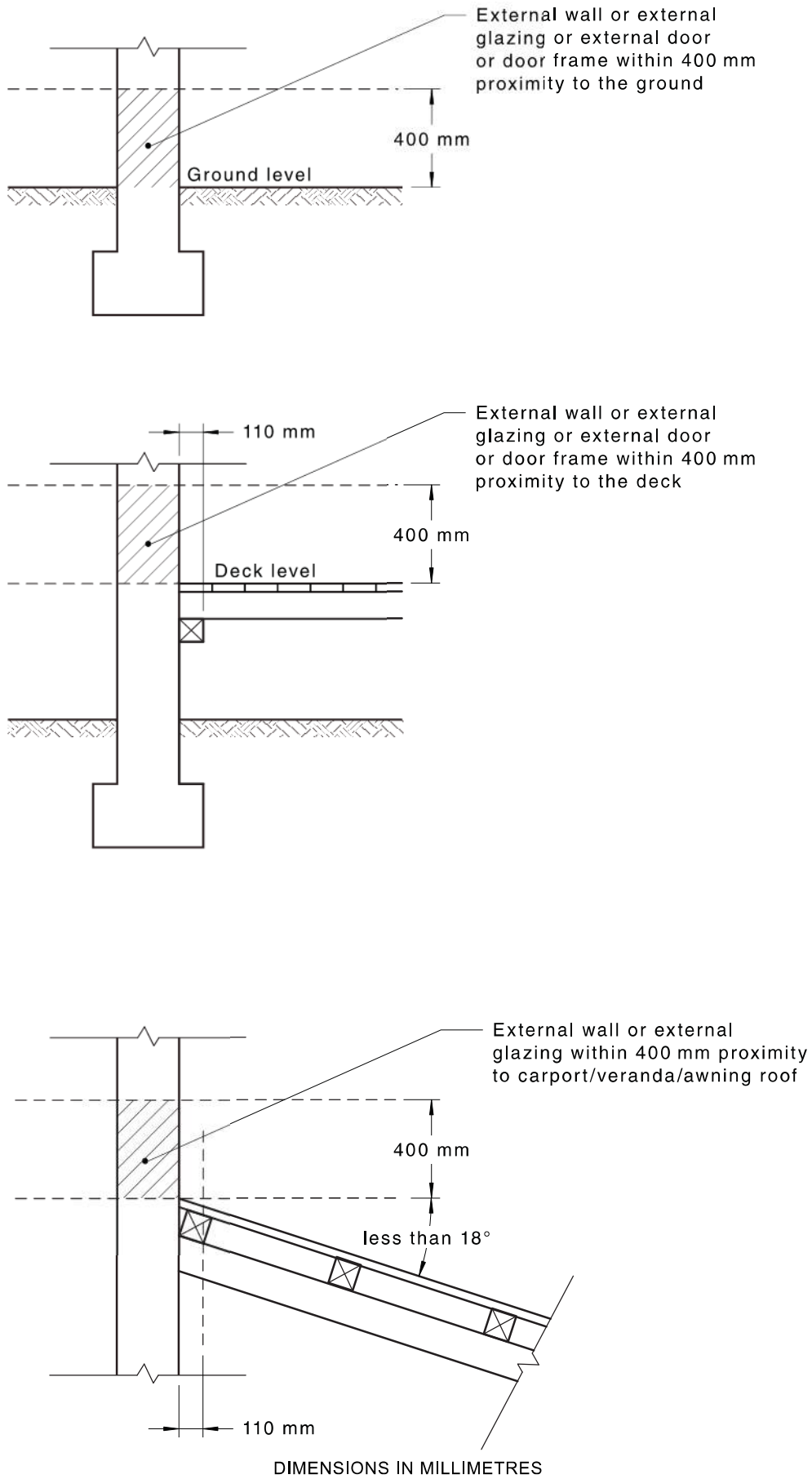

FIGURE D3 EXTERNAL WALLS OR EXTERNAL GLAZING, OR EXTERNAL DOORFRAMES WITHIN LIMITS ABOVE GROUND, DECKS, CARPORT ROOFS

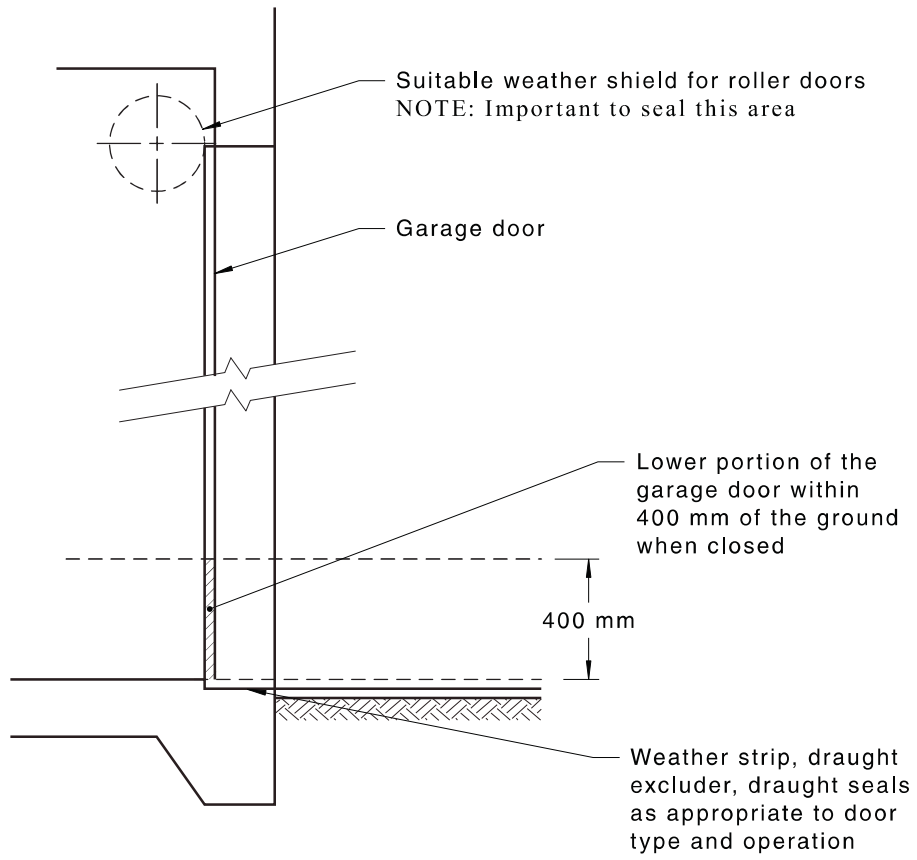

FIGURE D4 VEHICLE ACCESS DOORS (GARAGE DOORS)

APPENDIX E
TIMBER SPECIES AND DENSITIES
(Normative)

E1 GENERAL CONSTRUCTION

Timber that is in solid, laminated or reconstituted form with a density of 750 kg/m³ or greater at 12% moisture content is suitable for construction where specified in Sections 5, 6 and 7.

Examples of suitable timber species are listed in Table E1. Densities of timber species not listed in Table E1 may be found in AS 1720.2.

Many of the timber species listed in Table E1 from various regions of Australia may not be available in all areas.

TABLE E1
TIMBER SPECIES WITH A DENSITY
OF 750 kg/m³ OR GREATER

Standard trade name	Botanical name
Ash, Crow's	<i>Flindersia australis</i>
Ash, silvertop	<i>Eucalyptus sieberi</i>
Balau (selangan batu)	<i>Shorea spp.</i>
Bangkirai	<i>Shorea laevifolia</i>
Belian	<i>Eusideroxylon zwageri</i>
Blackbutt	<i>Eucalyptus pilularis</i>
Blackbutt, New England	<i>Eucalyptus andrewsii</i>
	<i>Eucalyptus campanulata</i>
Box, brush	<i>Lophostemon confertus</i>
Box, grey	<i>Eucalyptus microcarpa</i>
Box, grey, coast	<i>Eucalyptus bosistoana</i>
Box, white-topped	<i>Eucalyptus quadrangulata</i>
Box, yellow	<i>Eucalyptus melliodora</i>
Brownbarrel	<i>Eucalyptus fastigata</i>
Candlebark	<i>Eucalyptus rubida</i>
Gum, blue, southern	<i>Eucalyptus globulus</i>
Gum, blue, Sydney	<i>Eucalyptus saligna</i>
Gum, grey	<i>Eucalyptus propinqua</i>
Gum, grey, mountain	<i>Eucalyptus cypellocarpa</i>
Gum, Maiden's	<i>Eucalyptus maidenii</i>
Gum, manna	<i>Eucalyptus viminalis</i>
Gum, red, forest	<i>Eucalyptus tereticornis</i>

(continued)

TABLE E1 (continued)

Standard trade name	Botanical name
Gum, red, river	<i>Eucalyptus camaldulensis</i>
Gum, rose	<i>Eucalyptus grandis</i>
Gum, spotted	<i>Corymbia maculata</i>
	<i>Corymbia henryi</i>
	<i>Corymbia citriodora</i>
Gum, sugar	<i>Eucalyptus cladocalyx</i>
Hardwood, Johnstone River	<i>Backhousia bancroftii</i>
Ironbark, grey	<i>Eucalyptus paniculata</i>
Ironbark, red	<i>Eucalyptus sideroxylon</i>
Jarrah	<i>Eucalyptus marginata</i>
Kapur	<i>Dryobalanops spp.</i>
Karri	<i>Eucalyptus diversicolor</i>
Kempas	<i>Koompassia malaccensis</i>
Keruing	<i>Dipterocarpus spp.</i>
Kwila (Merbau)	<i>Intsia bijuga</i>
Mahogany red	<i>Eucalyptus resinifera</i>
Mahogany, southern	<i>Eucalyptus botryoides</i>
Mahogany, white	<i>Eucalyptus acmenoides</i>
Messmate	<i>Eucalyptus obliqua</i>
Messmate, Gympie	<i>Eucalyptus cloeziana</i>
Northern Box (Pelawan)	<i>Tristaniopsis spp</i>
Oak, American	<i>Quercus spp.</i>
Peppermint, narrow-leaved	<i>Eucalyptus australiana</i>
Satinay	<i>Syncarpia hillii</i>
Stringybark, Blackdown	<i>Eucalyptus sphaerocarpa</i>
Stringybark, blue-leaved	<i>Eucalyptus agglomerata</i>
Stringybark, brown	<i>Eucalyptus baxteri</i>
Stringybark, silvertop	<i>Eucalyptus laevopinea</i>
Stringybark, white	<i>Eucalyptus eugenioides</i>
Stringybark, yellow	<i>Eucalyptus muelleriana</i>
Tallowwood	<i>Eucalyptus microcorys</i>
Turpentine	<i>Syncarpia glomulifera</i>
Woollybutt	<i>Eucalyptus longifolia</i>

E2 WINDOWS AND DOORS

Timber species with a density of 650 kg/m³ or greater at a 12% moisture content is suitable for window joinery, door frames and the framing surrounding any glazing where specified in Sections 5 and 6. Examples of suitable timber species are listed in Table E2.

Densities of timber species not listed in Table E2 may be found in AS 1720.2.

Many of the timber species listed in Table E2 from various regions of Australia may not be available in all areas.

TABLE E2
SOME TIMBER SPECIES WITH A DENSITY
OF 650 kg/m³ OR GREATER

Standard trade name	Botanical name
Ash, alpine	<i>Eucalyptus delegatensis</i>
Ash, Crow's	<i>Flindersia australis</i>
Ash, mountain	<i>Eucalyptus regnans</i>
Ash, silvertop	<i>Eucalyptus sieberi</i>
Balau (selangan batu)	<i>Shorea spp.</i>
Bangkirai	<i>Shorea laevifolia</i>
Beech, myrtle	<i>Nothofagus cunninghamii</i>
Belian	<i>Eusideroxylon zwageri</i>
Blackbutt	<i>Eucalyptus pilularis</i>
Blackbutt, New England	<i>Eucalyptus andrewsii</i>
	<i>Eucalyptus campanulata</i>
Blackwood	<i>Acacia melanoxylon</i>
Box, brush	<i>Lophostemon confertus</i>
Box, grey	<i>Eucalyptus microcarpa</i>
Box, grey, coast	<i>Eucalyptus bosistoana</i>
Box, white-topped	<i>Eucalyptus quadrangulata</i>
Box, yellow	<i>Eucalyptus melliodora</i>
Brownbarrel	<i>Eucalyptus fastigata</i>
Candlebark	<i>Eucalyptus rubida</i>
Cypress	<i>Callitris glaucophylla</i>
Gum, blue, southern	<i>Eucalyptus globulus</i>
Gum, blue, Sydney	<i>Eucalyptus saligna</i>
Gum, grey	<i>Eucalyptus propinqua</i>
Gum, grey, mountain	<i>Eucalyptus cypellocarpa</i>
Gum, Maiden's	<i>Eucalyptus maidenii</i>
Gum, manna	<i>Eucalyptus viminalis</i>
Gum, mountain	<i>Eucalyptus dalrympleana</i>
Gum, red, forest	<i>Eucalyptus tereticornis</i>
Gum, red, river	<i>Eucalyptus camaldulensis</i>
Gum, rose	<i>Eucalyptus grandis</i>
Gum, shinning	<i>Eucalyptus nitens</i>
Gum, spotted	<i>Corymbia maculata</i>
	<i>Corymbia henryi</i>
	<i>Corymbia citriodora</i>
Gum, sugar	<i>Eucalyptus cladocalyx</i>

(continued)

TABLE E2 (continued)

Standard trade name	Botanical name
Hardwood, Johnstone River	<i>Backhousia bancroftii</i>
Ironbark, grey	<i>Eucalyptus paniculata</i>
Ironbark, red	<i>Eucalyptus sideroxylon</i>
Jarrah	<i>Eucalyptus marginata</i>
Kapur	<i>Dryobalanops spp.</i>
Karri	<i>Eucalyptus diversicolor</i>
Kempas	<i>Koompassia malaccensis</i>
Keruing	<i>Dipterocarpus spp.</i>
Kwila (Merbau)	<i>Intsia bijuga</i>
Mahogany, Philippine red, dark	<i>Shorea spp.</i>
Mahogany red	<i>Eucalyptus resinifera</i>
Mahogany, southern	<i>Eucalyptus botryoides</i>
Mahogany, white	<i>Eucalyptus acmenoides</i>
Messmate	<i>Eucalyptus obliqua</i>
Messmate, Gympie	<i>Eucalyptus cloeziana</i>
Northern Box (Pelawan)	<i>Tristaniopsis spp.</i>
Oak , American	<i>Quercus spp.</i>
Peppermint, narrow-leaved	<i>Eucalyptus australiana</i>
Pine, celery-top	<i>Phyllocladus asplenifolius</i>
Pine, slash	<i>Pinus elliotii</i>
Ramin	<i>Gonystylus spp.</i>
Rosewood, New Guinea	<i>Pterocarpus indicus</i>
Satinay	<i>Syncarpia hillii</i>
Stringybark, Blackdown	<i>Eucalyptus sphaerocarpa</i>
Stringybark, blue-leaved	<i>Eucalyptus agglomerata</i>
Stringybark, brown	<i>Eucalyptus baxteri</i>
Stringybark, silvertop	<i>Eucalyptus laevopinea</i>
Stringybark, white	<i>Eucalyptus eugenioides</i>
Stringybark, yellow	<i>Eucalyptus muelleriana</i>
Tallowwood	<i>Eucalyptus microcorys</i>
Taun	<i>Pometia pinnata</i>
Turpentine	<i>Syncarpia glomulifera</i>
Vitex, New Guinea	<i>Vitex cofassus</i>
Woollybutt	<i>Eucalyptus longifolia</i>

APPENDIX F BUSHFIRE-RESISTING TIMBER

(Normative)

F1 GENERAL

Bushfire-resisting timber is timber that is in solid, laminated or reconstituted form and has been tested and is deemed to be acceptable to withstand exposure up to a BAL—29 condition.

Timber may be ‘bushfire-resisting’ by means of one or more of—

- (a) the inherent properties of the material itself;
- (b) being impregnated with fire-retardant chemicals; or
- (c) the application of fire-retardant coatings or substrates.

F2 TESTING

The following applies:

- (a) To satisfy the requirements for bushfire-resisting timber, timber shall be tested in accordance with AS/NZS 3837 and shall meet the following criteria:
 - (i) The maximum heat release rate shall be not greater than 100 kW/m².
 - (ii) The average heat release rate for 10 minutes following ignition shall be not greater than 60 kW/m² when the material is exposed to an irradiance level of 25 kW/m².
- (b) Where the timber has been altered by chemicals, the test samples shall be subjected to the regime of accelerated weathering described in Paragraph F3 except that where the timber is protected from the weather, as described in the AS 1684 series (for example, cladding protected by a veranda), accelerated weathering of the test samples is not required before being tested to AS/NZS 3837.

External timbers are deemed to be protected if they are covered by a roof projection (or similar) at 30 degrees or greater to the vertical and they are well detailed and maintained (painted or stained and kept well ventilated).

NOTE: The purpose of testing is to assess timber performance rather than to simulate a bushfire. The irradiance set for the test is not to be considered to be correlated to the BAL.

F3 ACCELERATED WEATHERING

Where accelerated weathering is required before testing to AS/NZS 3837, external fire-retardant-coated substrates shall be subjected to the ASTM D2898 Method B weathering regime, with the water flow rate modified to be the same as that within ASTM D2898 Method A.

NOTE: Accelerated weathering does not account for mechanical wear and tear within trafficable areas and care should be exercised when using coating material.

F4 BUSHFIRE-RESISTING SPECIES

The species listed in Table F1 have been tested and have met the requirements of Paragraph F2.

A2

TABLE F1
BUSHFIRE-RESISTANT SPECIES

Standard trade name	Botanical name
Ash, silvertop	<i>Eucalyptus sieberi</i>
Blackbutt	<i>Eucalyptus pilularis</i>
Gum, red, river	<i>Eucalyptus camaldulensis</i>
Gum, spotted	<i>Corymbia maculata</i>
Ironbark, red	<i>Eucalyptus sideroxylon</i>
Kwila (Merbau)	<i>Intsia bijuga</i>
Turpentine	<i>Syncarpia glomulifera</i>

APPENDIX G
EXPLANATION OF BUSHFIRE ATTACK LEVELS (BALs)
(Informative)

G1 GENERAL

To determine the construction requirements for a building site, the threat or risk of bushfire attack needs to be assessed.

G2 RADIANT HEAT THRESHOLDS OF PAIN AND IGNITION

In a bushfire, radiant heat levels may be unsafe for humans and could also ignite combustible material in the vicinity. Table G1 provides an indication of the potential effects of radiant heat levels on both humans and selected material to assist the reader in understanding the implications of the different BALs.

A2

TABLE G1
TYPICAL RADIANT HEAT INTENSITIES
FOR VARIOUS PHENOMENA

Phenomena	kW/m ²
Pain to humans after 10 s to 20 s	4
Pain to humans after 3 s	10
Ignition of cotton fabric after a long time (piloted) (see Note 2)	13
Ignition of cotton fabric after a long time (non-piloted) (see Note 3)	25
Ignition of timber after a long time (non-piloted) (see Note 3)	25
Ignition of gaberdine fabric after a long time (non-piloted) (see Note 3)	27
Ignition of black drill fabric after a long time (non-piloted) (see Note 3)	38
Ignition of cotton fabric after 5 s (non-piloted) (see Note 3)	42
Ignition of timber in 20 s (non-piloted) (see Note 3)	45
Ignition of timber in 10 s (non-piloted) (see Note 3)	55

NOTES:

- 1 Source AS 1530.4—2005.
- 2 Introduction of a small flame to initiate ignition.
- 3 Flame not introduced to initiate ignition.

G3 BUSHFIRE ATTACK LEVELS (BALs) EXPLAINED

The 2009 edition of this Standard explains Bushfire Attack Levels (BALs) as follows:

(a) **BAL—LOW**

There is insufficient risk to warrant any specific construction requirements but there is still some risk.

(b) **BAL—12.5**

There is a risk of ember attack.

The construction elements are expected to be exposed to a heat flux not greater than 12.5 kW/m².

(c) **BAL—19**

There is a risk of ember attack and burning debris ignited by wind borne embers and a likelihood of exposure to radiant heat.

The construction elements are expected to be exposed to a heat flux not greater than 19 kW/m².

(d) **BAL—29**

There is an increased risk of ember attack and burning debris ignited by windborne embers and a likelihood of exposure to an increased level of radiant heat.

The construction elements are expected to be exposed to a heat flux not greater than 29 kW/m².

(e) **BAL—40**

There is a much increased risk of ember attack and burning debris ignited by windborne embers, a likelihood of exposure to a high level of radiant heat and some likelihood of direct exposure to flames from the fire front.

The construction elements are expected to be exposed to a heat flux not greater than 40 kW/m².

(f) **BAL—FZ**

There is an extremely high risk of ember attack and burning debris ignited by windborne embers, and a likelihood of exposure to an extreme level of radiant heat and direct exposure to flames from the fire front.

The construction elements are expected to be exposed to a heat flux greater than 40 kW/m².

APPENDIX H GENERIC ROOF SYSTEMS

(Normative)

H1 SCOPE

This Appendix provides two generic systems for skillion, hipped and gabled roofs which are deemed to satisfy the requirements of Clause 9.6 of this Standard.

NOTE: It should be noted that there are other tested proprietary roof systems which also satisfy the requirements for BAL—FZ.

H2 TILED ROOFS

Tiled roof construction (see Figure H1) shall comprise the following:

- A2 | (a) A thickness of 38 mm that conforms with AS/NZS 4859.1 and concrete or terracotta roof tiles that conform with AS 2049 with a mass equal to or greater than 46 kg/m² but no more than 56 kg/m². Roof tiles shall be clipped or screwed to the battens in accordance with AS 2050.
- (b) A continuous membrane of 15 mm tongue and grooved plywood fixed to timber or steel rafters or trusses. The face veneer shall be at right angles to the rafter or truss direction and the end joint over rafter edges or, if unavoidable, over a nogging. The plywood shall be continuous over more than one span and shall be fixed to the rafters or trusses where the fixing spacing shall be 150 mm centres at panel end and 300 mm centres at intermediate rafter, trusses or noggings. The plywood shall be fixed at not less than 10 mm from the panel edge. Fixings shall be—
- (i) hand-driven nails with 2.8 mm minimum diameter flathead or bullet head nails with a minimum length of 40 mm; *or*
- (ii) gun-driven nails with 2.5 mm minimum diameter gun nails with a minimum length of 40 mm; *or*
- (iii) self-drilled countersunk screws No. 8 × 30; *or*
- (iv) a combination of (i), (ii) or (iii).
- (c) A glasswool roofing blanket with a minimum R-value of R1.1 and having a minimum a density not less than 24 kg/m³, laid onto the plywood membrane in accordance with AS 3999.
- (d) Steel counter battens 40 mm in height and nominally 0.55 mm in thickness, installed on top of the glasswool roofing blanket and fixed through the plywood with fixings as required by the site location's tie-down requirements.
- A2 | (e) A 16 mm thick water- and fire-resistant plasterboard that conforms with AS/NZS 2588, acting as anti-ponding board, fixed to the counter battens and projecting beyond the fascia.
- (f) A sarking with a flammability index not greater than five, located directly above the counter battens and the anti-ponding board. The sarking shall cover the entire roof area including the ridge and shall be installed so that there are no gaps that would allow the entry of embers where the sarking meets fascias, gutters and valleys.
- (g) Steel roof tile battens 40 mm in height and nominally 0.55 mm in thickness, installed on top of the sarking and fixed to the counter battens as required by the site location's tie-down requirements.

- (h) A minimum 35 mm × 35 mm × 0.55 mm base metal thickness (BMT) galvanized angle fixed at minimum 600 mm centres along the plywood membrane ridge line to cover gaps.
- (i) A mineral wool strip, 115 mm thick and 100 mm wide with a density of not less than 80 kg/m³, and having a fusion temperature in excess of 1120 °C and long-term surface operating temperature of not less than 650°C, installed—
- (i) between the sarking and the ridge cap; and
 - (ii) at any gap under the anti-ponding board and the glasswool blanket.
- (j) Fascias and bargeboards of a membrane of 15 mm plywood installed over timber or steel framing or trusses and including the following:
- A2 | (i) A 16 mm thick water- and fire-resistant plasterboard that conforms with AS/NZS 2588 and fixed into the plywood with 38 mm × 6 g screws at 150 mm centres. The butt joints between plasterboards sheets shall not fall on joints in the plywood. Joints shall be left open 6 mm to 10 mm wide and filled with fire-resistant sealant.
- (ii) A timber fascia fixed to rafter or trusses in accordance with the AS 1684 series.
- (iii) A minimum 35 mm × 35 mm × 0.70 mm BMT galvanized angle fixed at minimum 600 mm centres along the bottom truss corner or the interface of rafter to framing.
- (iv) A flexible fire-resistant sealant installed at the interface of the 16 mm water- and fire-resistant plasterboard fixed to the eaves, and the 16 mm water- and fire-resistant plasterboard fixed to the fascia.
- (k) Eaves lining of a membrane of 15 mm plywood installed over timber or steel framing or trusses, and including the following:
- A2 | (i) A 16 mm water- and fire-resistant plasterboard that conforms with AS/NZS 2588, fixed into the plywood with 38 mm × 6 g screws at 150 mm centres. The butt joints between plasterboards sheets shall not fall on joints in the plywood.
- (ii) A minimum of 4.5 mm fibre cement eaves lining to protect the plasterboard fixed into the plywood.
- (iii) A minimum 35 mm × 35 mm × 0.70 mm BMT galvanized angle fixed at minimum 600 mm centres along the plywood to wall stud interface.

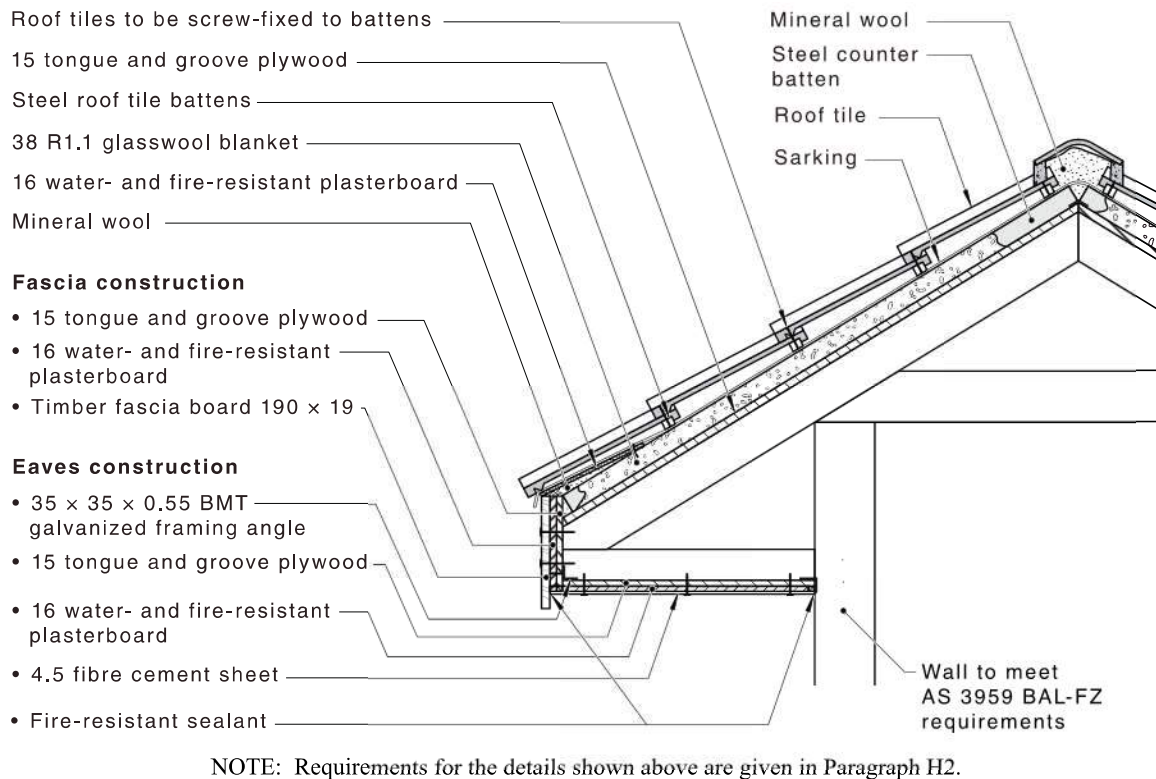

DIMENSIONS IN MILLIMETRES

FIGURE H1 TILED ROOF DETAIL

H3 SHEET ROOFS

Sheet roof construction (see Figure H2) shall comprise the following:

- (a) A continuous membrane of 15 mm tongue and groove plywood fixed to timber or steel rafters or trusses. The face veneer shall be at right angles to the rafter or truss direction and the end joint over rafter edges or, if unavoidable, over a nogging. The plywood shall be continuous over more than one span and shall be fixed to the rafters or trusses where the fixing spacing shall be 150 mm centres at panel end and 300 mm centres at intermediate rafter, trusses or noggings. The plywood shall be fixed at not less than 10 mm from the panel edge. Fixings shall be—
 - (i) hand-driven nails with 2.8 mm minimum diameter flathead or bullet head nails with a minimum length of 40 mm; *or*
 - (ii) gun-driven nails with 2.5 mm minimum diameter gun nails with a minimum length of 40 mm; *or*
 - (iii) self-drilled countersunk screws No. 8 × 30; *or*
 - (iv) a combination of (i), (ii) or (iii).
- (b) Timber batten with a maximum size of 45 mm × 90 mm (on flat), fixed through the plywood with fixings as required by the site location's tie-down requirements and the AS 1684 series.

or

Steel top hat battens 40 mm in height and nominally 0.55 mm in thickness fixed through the plywood to the roof framing as required by the site location's tie-down requirements.

- A2 | (c) A glasswool roofing blanket with a minimum R-value of R1.8 and a minimum thickness of 75 mm, laminated with light duty reflective foil, that conforms with AS/NZS 4859.1 and having a density not less than 11 kg/m³, installed in accordance with AS 3999 with the reflective foil facing down and filling the void between the plywood membrane and the sheet roof.
- A2 | (d) Corrugated roof sheets with BMT between 0.42 mm to 0.6 mm that conforms with AS 1445 fixed to battens with at least one fixing every second corrugation in the field of the roof and at the edge of the roof at locations such as fascia, hip, bargeboard and valley, fixed at every corrugation. Fixings shall be a self-drilling hex head screw, with EPDM seal and shank guard.
- (e) A mineral wool strip, 115 mm thick and 100 mm wide with a density of not less than 80 kg/m³, and having a fusion temperature in excess of 1120°C and long-term surface operating temperature of not less than 650°C, installed—
- (i) between the sarking and the ridge cap; and
 - (ii) above the glasswool roofing blanket compressed to 50% of its thickness into the interface of the roof sheet, fascia and plywood membrane.
- (f) A minimum 35 mm × 35 mm × 0.55 mm BMT galvanized angle fixed at minimum 600 mm centres along the plywood membrane ridge line to cover gaps.
- (g) A 40 mm × 40 mm × 40 × 0.55 mm BMT galvanized Z flashing fixed at minimum 600 mm centres along the eaves end into the plywood membrane.
- (h) A flexible fire-resistant sealant installed between the Z flashing and fascia.
- (i) Fascias and bargeboards of a membrane of 15 mm plywood installed over timber or steel framing or trusses and including the following:
- A2 | (i) A 16 mm water- and fire-resistant plasterboard that conforms with AS/NZS 2588 and fixed into the plywood with 38 mm × 6 g screws at 150 mm centres. The butt joints between plasterboard sheets shall not fall on joints in the plywood. Joints shall be left open 6 mm to 10 mm wide and filled with fire-resistant sealant.
- (ii) A timber fascia fixed to rafter or trusses in accordance with the AS 1684 series.
- (iii) A minimum 35 × 35 × 0.70 mm BMT galvanized angle fixed at minimum 600 mm centres along the bottom truss corner or the interface of rafter to framing.
- (iv) A flexible fire-resistant sealant installed at the interface of the 16 mm water- and fire-resistant plasterboard fixed to the eaves and the 16 mm water- and fire-resistant plasterboard fixed to the fascia.
- (j) Eaves lining of a membrane of 15 mm plywood installed over timber or steel framing or trusses, and including the following:
- A2 | (i) A 16 mm water- and fire-resistant plasterboard that conforms with AS/NZS 2588, fixed into the plywood with 38 mm × 6 g screws at 150 mm centres. The butt joints between plasterboard sheets shall not fall on joints in the plywood.
- (ii) A minimum of 4.5 mm fibre-cement eaves lining to protect the plasterboard fixed into the plywood.
- (iii) A minimum 35 × 35 × 0.70 mm BMT galvanized angle fixed at minimum 600 mm centres along the plywood to wall stud interface.

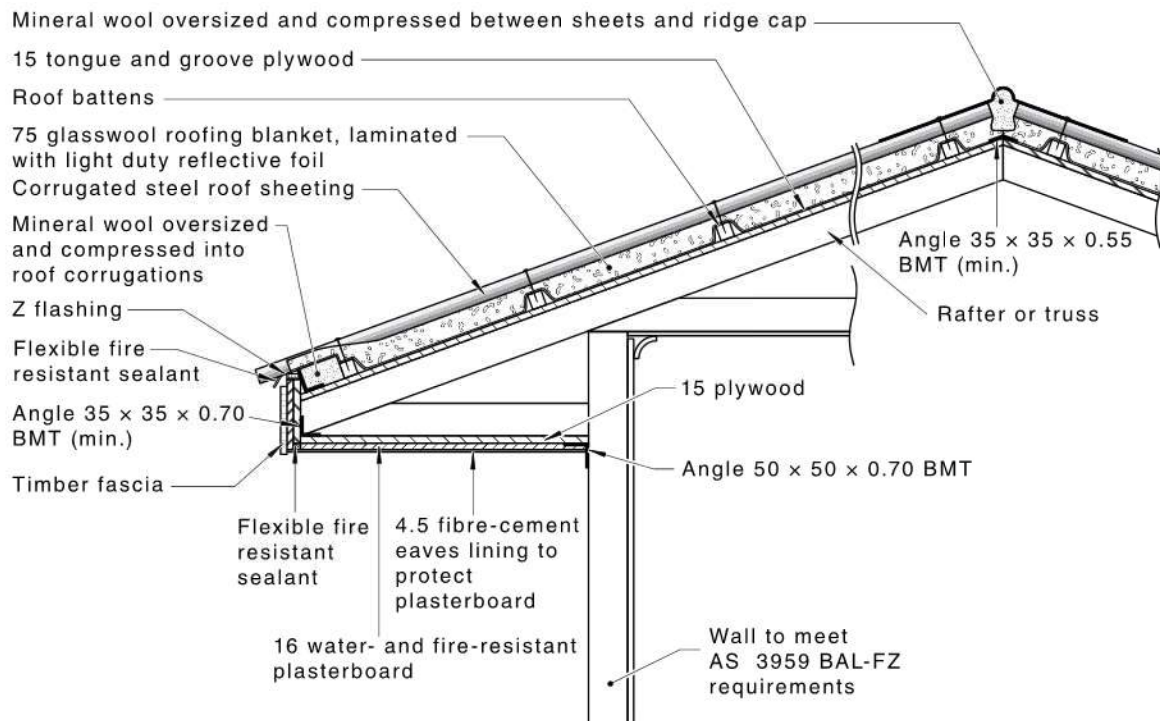

NOTE: Requirements for the detail shown above are given in Paragraph H3.

DIMENSIONS IN MILLIMETRES

FIGURE H2 SHEET ROOF DETAIL

BIBLIOGRAPHY

AS

- 1720 Timber structures
- 1720.2 Part 2: Timber properties
- 4566 Flue cowls—Gas appliances

AS/NZS

- 4505 Garage doors and other large access doors
- 4645 Gas distribution networks
- 4645.1 Part 1: Network management
- 5601 Gas installations
- 5601.1 Part 1: General installations

<http://www.bom.gov.au/nsw/forecasts/fire-forecasts.shtml>

A2

‘Text deleted’

AMENDMENT CONTROL SHEET**AS 3959:2018**

Amendment No. 1 (2019)

CORRECTION

SUMMARY: This Amendment applies to Clause 7.6.5 and Table B3.

Published on 25 June 2019.

Amendment No. 2 (2020)

REVISED TEXT

SUMMARY: This Amendment applies to the following:

- Preface.
- Clauses 1.4, 1.5.10, 2.2.1, 3.6.2, 3.8, 3.10, 5.2, 5.3.2.1, 5.4.1, 5.5.3, 5.5.4, 5.5.5, 5.6.5, 5.6.6, 5.7.1, 5.7.3.3, 6.1, 6.2, 6.4.1, 6.5.3, 6.5.4, 6.5.5, 6.5.6, 6.6.6, 6.7.1, 6.7.5, 7.2, 7.3.2.2, 7.4.1, 7.5.6, 7.6.5, 7.7.1, 7.7.5, 8.4.1, 8.5.3, 8.5.4, 8.5.5, 8.5.6, 8.6.5, 8.6.6, 9.2, 9.5.6, 9.6.6, 9.8, B2, B3 and B10.3.
- Figure 3.2.
- Tables 2.3, B3, B4 and B5.
- Appendix B References.
- Bibliography.

Published on 18 December 2020.

NOTES

NOTES

NOTES

Standards Australia

Standards Australia develops Australian Standards® and other documents of public benefit and national interest. These Standards are developed through an open process of consultation and consensus, in which all interested parties are invited to participate. Through a Memorandum of Understanding with the Commonwealth Government, Standards Australia is recognized as Australia's peak non-government national standards body. Standards Australia also supports excellence in design and innovation through the Australian Design Awards.

For further information visit www.standards.org.au

Australian Standards®

Committees of experts from industry, governments, consumers and other relevant sectors prepare Australian Standards. The requirements or recommendations contained in published Standards are a consensus of the views of representative interests and also take account of comments received from other sources. They reflect the latest scientific and industry experience. Australian Standards are kept under continuous review after publication and are updated regularly to take account of changing technology.

International Involvement

Standards Australia is responsible for ensuring the Australian viewpoint is considered in the formulation of International Standards and that the latest international experience is incorporated in national Standards. This role is vital in assisting local industry to compete in international markets. Standards Australia represents Australia at both the International Organization for Standardization (ISO) and the International Electrotechnical Commission (IEC).

For information regarding the development of Standards contact:

Standards Australia Limited
GPO Box 476
Sydney NSW 2001
Phone: 02 9237 6000
Email: mail@standards.org.au
Internet: www.standards.org.au



ISBN 978 1 76072 253 1